

CTS1 - CTS13 CTS32 - CTS1M

Solid tantalum MnO₂ capacitors
Hermetically sealed metal cases
Axial leads
General purpose - Standard range
Polarized



ELECTRICAL AND CLIMATIC CHARACTERISTICS

	CTS1	CTS13	CTS32	CTS1M
Detail specification	CECC 30201-001 CECC 30201-002 CECC 30201-801	CECC 30201-005	CECC 30201-019	According to MIL-PRF-39003/01
Operating temperature	-55°C +125°C	-55°C +85°C	-55°C +125°C	-55°C +125°C
Damp heat	56 days	56 days	56 days	56 days
Capacitance range	0,1μF ⇒ 330μF	0,1μF ⇒ 330μF	1μF ⇒ 330μF	0,1μF ⇒ 330μF
Tolerance	±10% - ±20%	±10% - ±20%	±10% - ±20%	±10% - ±20%
Voltage range	6,3V ⇒ 125V	6,3V ⇒ 63V	6,3V ⇒ 63V	6,3V ⇒ 100V
Max. capacitance change -55°C	-10%	-10%	-10%	-10%
Max. capacitance change +85°C	+12%	+12%	+12%	+8%
Max. capacitance change +125°C	+15%	-	+15%	+12%
Maximum DF at +20°C	see table	see table	see table	see table
Maximum DF at -55°C	1,5 x lim20°C	1,5 x lim20°C	1,5 x lim20°C	= lim20°C
Maximum DF at +85°C	1,5 x lim20°C	1,5 x lim20°C	1,5 x lim20°C	= lim20°C
Maximum DF at +125°C	2,0 x lim20°C		2,0 x lim20°C	= lim20°C
Max. leakage current at +20°C	see table	see table	see table	see table
Max. leakage current at +85°C	0,1 x C _R U _R	0,1 x C _R U _R	0,1 x C _R U _R	20 x lim 20°C
Max. leakage current at +125°C	0,125 x C _R U _R	-	0,125 x C _R U _R	25 x lim 20°C
Max. impedance (20°C): case A	10 Ω	10 Ω	10 Ω	10 Ω
Max. impedance (20°C): case B	5 Ω	5 Ω	5 Ω	5 Ω
Max. impedance (20°C): case C	2 Ω	2 Ω	2 Ω	2 Ω
Max. impedance (20°C): case D	1 Ω	1 Ω	1 Ω	1 Ω
High surge current	no	no	1 million cycles	3 cycles-100%
Max. Reverse voltage at +20°C	-	-	15 % U _R	15 % U _R
Max. Reverse voltage at +85°C	-	-	5 % U _R	5 % U _R
Max. Reverse voltage at +125°C	-	-	1 % U _R	1 % U _R
Max. surge voltage at +85°C	1,3 x U _R	1,3 x U _R	1,3 x U _R	1,3 x U _R
Max. surge voltage at +125°C	1,3 x U _C	-	1,3 x U _C	1,3 x U _C

DIMENSIONS (mm)

Case code	Dimensions with insulating sleeve			
	Lt max	L max	D max	d +10% / -0,05
A	10,2	8,1	3,6	0,5
B	15,0	12,8	4,9	0,5
C	20,5	18,2	7,5	0,6
D	24,0	20,8	9,1	0,6

MARKING, PACKAGING, CONSTRUCTION:
see general characteristics

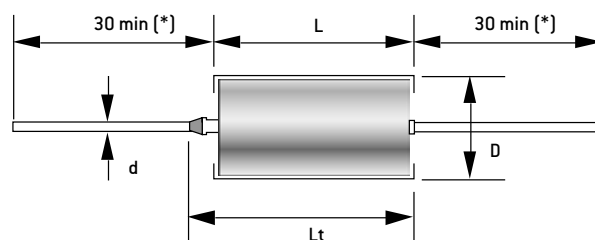

(*) 23mm for capacitors delivered on tape

HOW TO ORDER

Commercial description	Model				Case	Capacitance in μF	Tolerance in %	DC Voltage	Termination
	CTS1	CTS13	CTS32	CTS1M					
					D	150μF	20%	16V	H
EXXELIA PN	Model code				Case	Capacitance code	Tolerance code	DC Voltage code	Termination
	TS01	TS13	TS32	TS01M	D	157	M	016	A

Expressed in pF with 3 digits:
2 digits for the value
and the third for the multiplier

K = 10%
M = 20%

Expressed in volt
with 3 digits

Commercial description
H = SnPb (non RoHS)
- = Sn100% (RoHS)

EXXELIA PN
A = SnPb (non RoHS)
F = Sn100% (RoHS)

CTS1 - CTS13 CTS32 - CTS1M

STANDARD RATINGS - ELECTRICAL CHARACTERISTICS

Capacitance 100Hz +20°C [μF]	Case (code)	Type			Max. leakage current			Max. DF +20°C [%]	Type	Max. leakage current			Max. DF. +25°C [%]
					+20°C [μA]	+85°C [μA]	+125°C [μA]			+25°C [μA]	+85°C [μA]	+125°C [μA]	
Rated voltage (+85°C) 6,3 V (6 V for CTS1M) - Category voltage (+125°C) 4 V													
5,6	A	CTS1	CTS13	CTS32	1	3,5	4,4	6	CTS1M	0,3	6	7,5	4
6,8	A	CTS1	CTS13	CTS32	1	4,2	5,3	6	CTS1M	0,3	6	7,5	6
47	B	CTS1	CTS13	CTS32	2,9	29	36	6	CTS1M	1,5	24	30	6
56	B	CTS1	CTS13	CTS32	3,5	35	44	6	CTS1M	1,5	24	30	6
120	C			CTS32	7,5	75	94	6					
150	C	CTS1	CTS13	CTS32	9,4	94	117	6	CTS1M	4,5	90	113	8
180	C	CTS1	CTS13	CTS32	11,3	113	141	6	CTS1M	5,5	110	138	8
270	D	CTS1	CTS13	CTS32	17	170	212	6	CTS1M	6,5	130	163	8
330	D	CTS1	CTS13	CTS32	20,8	208	260	8	CTS1M	7,5	150	188	8
Rated voltage (+85°C) 10 V - Category voltage (+125°C) 6,3 V													
3,9	A	CTS1	CTS13	CTS32	1	3,9	4,8	6	CTS1M	0,3	6	7,5	4
4,7	A	CTS1	CTS13	CTS32	1	4,7	5,8	6	CTS1M	0,4	7	8,8	4
27	B	CTS1	CTS13	CTS32	2,7	27	34	6	CTS1M	2	40	50	6
33	B	CTS1	CTS13	CTS32	3,3	33	41	6	CTS1M	2,5	50	63	6
39	B	CTS1	CTS13	CTS32	3,9	39	49	6	CTS1M	2,5	50	63	6
82	C	CTS1	CTS13	CTS32	8,2	82	102	6	CTS1M	4	80	100	6
100	C	CTS1	CTS13	CTS32	10	100	125	6	CTS1M	5	100	125	8
120	C	CTS1	CTS13		12	120	150	6	CTS1M	6	120	150	8
180	D	CTS1	CTS13	CTS32	18	180	225	6	CTS1M	9	180	226	8
220	D	CTS1	CTS13	CTS32	22	220	275	8	CTS1M	10	200	250	8
Rated voltage (+85°C) 16 V (15 V for CTS1M) - Category voltage (+125°C) 10 V													
1,8	A	CTS1		CTS32	1	2,8	3,6	6					
2,2	A	CTS1		CTS32	1	3,5	4,4	6					
2,7	A	CTS1	CTS13	CTS32	1	4,3	5,4	6	CTS1M	0,3	6	7,5	4
3,3	A	CTS1	CTS13	CTS32	1	5,2	6,6	6	CTS1M	0,4	8	10	4
12	B	CTS1		CTS32	1,9	19	24	6					
15	B	CTS1		CTS32	2,4	24	30	6					
18	B	CTS1	CTS13	CTS32	2,8	28	35	6	CTS1M	2	35	44	6
22	B	CTS1	CTS13	CTS32	3,5	35	43,7	6	CTS1M	2	40	50	6
39	C	CTS1		CTS32	6,2	62	77,5	6					
47	C	CTS1		CTS32	7,5	75	93,7	6					
56	C	CTS1	CTS13	CTS32	8,9	89	111	6	CTS1M	4	80	100	6
68	C	CTS1	CTS13	CTS32	10,8	108	135	6	CTS1M	5	100	125	6
82	D	CTS1		CTS32	13,1	131	163	6					
100	D	CTS1		CTS32	16	160	200	6					
120	D	CTS1	CTS13	CTS32	19,2	192	240	8	CTS1M	9	180	226	8
150	D	CTS1	CTS13	CTS32	24	240	300	8	CTS1M	10	200	250	8
Rated voltage (+85°C) 20 V - Category voltage (+125°C) 13 V													
1,2	A								CTS1M	0,3	6	7,5	4
1,5	A								CTS1M	0,3	6	7,5	4
1,8	A		CTS13		1	3,6		6	CTS1M	0,3	6	7,5	4
2,2	A		CTS13		1	4,4		6	CTS1M	0,4	8	10	4
8,2	B								CTS1M	1	20	25	6
10	B								CTS1M	1,5	30	38	6
12	B		CTS13		2,4	24		6	CTS1M	1,8	35	44	6
15	B		CTS13		3	30		6	CTS1M	2	40	50	6
27	C								CTS1M	2,5	50	63	6
33	C								CTS1M	3,5	70	88	6
39	C		CTS13		7,8	78		6	CTS1M	4	80	100	6
47	C		CTS13		9,4	94		6	CTS1M	4,5	90	113	6
56	D								CTS1M	5,5	110	138	6
68	D								CTS1M	7	140	175	6
82	D		CTS13		16,4	164		6	CTS1M	8	160	200	6
100	D		CTS13		20	200		8	CTS1M	10	200	250	8
Rated voltage (+85°C) 25 V - Category voltage (+125°C) 16 V													
1,2	A			CTS32	1	3	3,7	6					
1,5	A	CTS1	CTS13	CTS32	1	3,7	4,6	6					
8,2	B	CTS1	CTS13	CTS32	2	20	25	6					
10	B	CTS1	CTS13	CTS32	2,5	25	31,2	6					

CTS1 - CTS13 CTS32 - CTS1M

STANDARD RATINGS - ELECTRICAL CHARACTERISTICS

Capacitance 100Hz +20°C (μF)	Case (code)	Type			Max. leakage current			Max. DF +20°C (%)	Type	Max. leakage current			Max. DF+25°C (%)
					+20°C (μA)	+85°C (μA)	+125°C (μA)			+25°C (μA)	+85°C (μA)	+125°C (μA)	
Rated voltage (+85°C) 25 V - Category voltage (+125°C) 16 V													
27	C	CTS1	CTS13	CTS32	6,7	67	84	6					
33	C	CTS1	CTS13	CTS32	8,2	82	102	6					
56	D	CTS1	CTS13	CTS32	14	140	175	6					
68	D	CTS1	CTS13	CTS32	17	170	212	6					
Rated voltage (+85°C) 40 V (35 V for CTS1M) - Category voltage (+125°C) 25 V (23 V for CTS1M)													
0,1	A	CTS1	CTS13		1	1	1	6					
0,12	A	CTS1	CTS13		1	1	1	6					
0,15	A	CTS1	CTS13		1	1	1	6					
0,18	A	CTS1	CTS13		1	1	1	6					
0,22	A	CTS1	CTS13		1	1	1,1	6					
0,27	A	CTS1	CTS13		1	1	1,3	6					
0,33	A	CTS1	CTS13		1	1,3	1,6	6					
0,39	A	CTS1	CTS13		1	1,5	1,9	6					
0,47	A	CTS1	CTS13		1	1,8	2,3	6					
0,56	A	CTS1	CTS13		1	2,2	2,8	6					
0,68	A	CTS1	CTS13		1	2,7	3,4	6					
0,82	A	CTS1	CTS13		1	3,2	4,1	6					
1	A	CTS1	CTS13	CTS32	1	4	5	6					
1,2	B	CTS1	CTS13	CTS32	1	4,8	6	6					
1,5	B	CTS1	CTS13	CTS32	1	6	7,5	6					
1,8	B	CTS1	CTS13	CTS32	1	7,2	9	6					
2,2	B	CTS1	CTS13	CTS32	1	8,8	11	6					
2,7	B	CTS1	CTS13	CTS32	1	10	13,5	6					
3,3	B	CTS1	CTS13	CTS32	1,3	13	16,2	6					
3,9	B	CTS1	CTS13	CTS32	1,5	15	18,7	6					
4,7	B	CTS1	CTS13	CTS32	1,8	18	22,5	6					
5,6	B	CTS1	CTS13	CTS32	2,2	22	27,5	6	CTS1M	1,3	25	32	4
6,8	B	CTS1	CTS13	CTS32	2,7	27	33,7	6	CTS1M	1,5	30	38	6
8,2	C	CTS1	CTS13	CTS32	3,2	32	40	6					
10	C	CTS1	CTS13	CTS32	4	40	50	6					
12	C	CTS1	CTS13	CTS32	4,8	48	60	6					
15	C	CTS1	CTS13	CTS32	6	60	75	6					
18	C	CTS1	CTS13	CTS32	7,2	72	90	6					
22	C	CTS1	CTS13	CTS32	8,8	88	110	6	CTS1M	4	80	100	6
27	D	CTS1	CTS13	CTS32	10,8	108	135	6	CTS1M	4,5	90	113	6
33	D	CTS1	CTS13	CTS32	13,2	132	165	6	CTS1M	5,5	110	138	6
39	D	CTS1	CTS13	CTS32	15,6	156	195	6	CTS1M	7	140	175	6
47	D	CTS1	CTS13	CTS32	18,8	188	235	6	CTS1M	8	160	200	6
Rated voltage (+85°C) 50 V - Category voltage (+125°C) 32 V													
0,1	A	CTS1	CTS13		1	1	1	6	CTS1M	0,3	5	6,3	2
0,12	A	CTS1	CTS13		1	1	1	6	CTS1M	0,3	5	6,3	2
0,15	A	CTS1	CTS13		1	1	1	6	CTS1M	0,3	5	6,3	2
0,18	A	CTS1	CTS13		1	1	1,1	6	CTS1M	0,3	5	6,3	2
0,22	A	CTS1	CTS13		1	1,1	1,3	6	CTS1M	0,3	5	6,3	2
0,27	A	CTS1	CTS13		1	1,3	1,6	6	CTS1M	0,3	5	6,3	2
0,33	A	CTS1	CTS13		1	1,6	2	6	CTS1M	0,3	5	6,3	2
0,39	A	CTS1	CTS13		1	1,9	2,4	6	CTS1M	0,3	5	6,3	2
0,47	A	CTS1	CTS13		1	2,3	2,9	6	CTS1M	0,3	5	6,3	2
0,56	A	CTS1	CTS13		1	2,8	3,5	6	CTS1M	0,3	5	6,3	2
0,68	A	CTS1	CTS13		1	3,4	4,2	6	CTS1M	0,3	5	6,3	2
0,82	A	CTS1	CTS13		1	4,1	5,1	6	CTS1M	0,3	5	6,3	2
1	A	CTS1	CTS13	CTS32	1	5	6,2	6	CTS1M	0,4	8	10	2
1,2	B	CTS1	CTS13	CTS32	1	6	7,5	6	CTS1M	0,4	9	11	4
1,5	B	CTS1	CTS13	CTS32	1	7,5	9,3	6	CTS1M	0,6	12	15	4
1,8	B	CTS1	CTS13	CTS32	1	9	11,2	6	CTS1M	0,7	14	18	4
2,2	B	CTS1	CTS13	CTS32	1,1	11	13,7	6	CTS1M	0,8	17	22	4
2,7	B	CTS1	CTS13	CTS32	1,3	13	16,2	6	CTS1M	1	20	25	4
3,3	B	CTS1	CTS13	CTS32	1,6	16	20	6	CTS1M	1,2	25	32	4
3,9	B	CTS1	CTS13	CTS32	1,9	19	24	6	CTS1M	1,5	30	38	4
4,7	B	CTS1	CTS13	CTS32	2,3	23	29	6	CTS1M	1,7	35	44	4
5,6	C	CTS1	CTS13	CTS32	2,8	28	35	6	CTS1M	2,2	45	56	4
6,8	C	CTS1	CTS13	CTS32	3,4	34	42	6	CTS1M	2,2	45	56	6
8,2	C	CTS1	CTS13	CTS32	4,1	41	51	6	CTS1M	2,5	50	63	6
10	C	CTS1	CTS13	CTS32	5	50	62	6	CTS1M	2,5	50	63	6

CTS1 - CTS13 CTS32 - CTS1M

STANDARD RATINGS - ELECTRICAL CHARACTERISTICS

Capacitance 100Hz +20°C (μF)	Case (code)	Type			Max. leakage current			Max. DF +20°C (%)	Type	Max. leakage current			Max. DF +25°C (%)
					+20°C (μA)	+85°C (μA)	+125°C (μA)			+25°C (μA)	+85°C (μA)	+125°C (μA)	
Rated voltage (+85°C) 50 V - Category voltage (+125°C) 32 V													
12	C	CTS1	CTS13	CTS32	6	60	75	6	CTS1M	3	60	75	6
15	C	CTS1	CTS13	CTS32	7,5	75	93	6	CTS1M	4	80	100	6
18	C	CTS1	CTS13	CTS32	9	90	112	6	CTS1M	4,5	90	113	6
22	D	CTS1	CTS13	CTS32	11	110	137	6	CTS1M	5,5	110	138	6
Rated voltage (+85°C) 63 V - Category voltage (+125°C) 40 V													
0,1	A	CTS1	CTS13		1	1	1	6					
0,12	A	CTS1	CTS13		1	1	1	6					
0,15	A	CTS1	CTS13		1	1	1,1	6					
0,18	A	CTS1	CTS13		1	1,1	1,4	6					
0,22	A	CTS1	CTS13		1	1,3	1,7	6					
0,27	A	CTS1	CTS13		1	1,7	2,1	6					
0,33	A	CTS1	CTS13		1	2	2,5	6					
0,39	A	CTS1	CTS13		1	2,4	3	6					
0,47	A	CTS1	CTS13		1	2,9	3,7	6					
0,56	A	CTS1	CTS13		1	3,5	4,4	6					
0,68	A	CTS1	CTS13		1	4,2	5,3	6					
0,82	B	CTS1	CTS13		1	5,1	6,4	6					
1	B	CTS1	CTS13	CTS32	1	6,3	7,8	6					
1,2	B	CTS1	CTS13	CTS32	1	7,5	9,4	6					
1,5	B	CTS1	CTS13	CTS32	1	9,4	11,8	6					
1,8	B	CTS1	CTS13	CTS32	1,1	11	13,7	6					
2,2	B	CTS1	CTS13	CTS32	1,3	13	16,2	6					
2,7	B	CTS1	CTS13	CTS32	1,7	17	21,2	6					
3,3	B	CTS1	CTS13	CTS32	2	20	25	6					
3,9	B	CTS1	CTS13	CTS32	2,4	24	30	6					
4,7	C	CTS1	CTS13	CTS32	2,9	29	37	6					
5,6	C	CTS1	CTS13	CTS32	3,5	35	44	6					
6,8	C	CTS1	CTS13	CTS32	4,2	42	53	6					
8,2	C	CTS1	CTS13	CTS32	5,1	51	64	6					
10	C	CTS1	CTS13	CTS32	6,3	63	78	6					
12	D	CTS1	CTS13	CTS32	7,5	75	94	6					
15	D	CTS1	CTS13	CTS32	9,4	94	118	6					
18	D	CTS1	CTS13	CTS32	11,3	113	141	6					
22	D	CTS1	CTS13	CTS32	13,8	138	173	6					
Rated voltage (+85°C) 80 V (75 V for CTS1M) - Category voltage (+125°C) 50 V													
0,1	A	CTS1			1	1	1	6	CTS1M	0,3	5	6,3	2
0,12	A	CTS1			1	1	1,2	6	CTS1M	0,3	5	6,3	2
0,15	A	CTS1			1	1,2	1,5	6	CTS1M	0,3	5	6,3	2
0,18	A	CTS1			1	1,4	1,8	6	CTS1M	0,3	5	6,3	2
0,22	A	CTS1			1	1,7	2,2	6	CTS1M	0,3	5	6,3	2
0,27	A	CTS1			1	2,1	2,7	6	CTS1M	0,3	5	6,3	2
0,33	A	CTS1			1	2,6	3,3	6	CTS1M	0,3	5	6,3	2
0,39	A	CTS1			1	3,1	3,9	6	CTS1M	0,3	5	6,3	2
0,47	A	CTS1			1	3,7	4,7	6	CTS1M	0,3	5	6,3	2
0,56	A	CTS1			1	4,4	5,6	6	CTS1M	0,3	5	6,3	2
0,68	A	CTS1			1	5,4	6,8	6	CTS1M	0,3	5	6,3	2
0,82	B	CTS1			1	6,5	8,2	6	CTS1M	0,3	5	6,3	2
1	B	CTS1			1	8	10	6	CTS1M	0,3	5	6,3	2
1,2	B	CTS1			1	9,6	12	6	CTS1M	0,3	5	6,3	4
1,5	B	CTS1			1,2	12	15	6	CTS1M	0,6	10	13	4
1,8	B	CTS1			1,4	14	18	6	CTS1M	0,7	10	13	4
2,2	B	CTS1			1,7	17	22	6	CTS1M	0,8	15	19	4
2,7	B	CTS1			2,1	21	27	6	CTS1M	1	15	19	4
3,3	B	CTS1			2,6	26	33	6	CTS1M	1,2	20	25	4
3,9	B	CTS1			3,1	31	39	6	CTS1M	1,5	20	25	4
4,7	C	CTS1			3,7	37	47	6	CTS1M	3	60	75	4
5,6	C	CTS1			4,4	44	56	6	CTS1M	3	60	75	4
6,8	C	CTS1			5,4	54	68	6	CTS1M	5	100	125	6
8,2	C	CTS1			6,5	65	82	6	CTS1M	5	100	125	6
10	C	CTS1			8	80	100	6	CTS1M	5	100	125	6
12	D	CTS1			9,6	96	120	6	CTS1M	5	100	125	6
15	D	CTS1			12	120	150	6	CTS1M	7	140	175	6

CTS1 - CTS13

CTS32 - CTS1M

STANDARD RATINGS - ELECTRICAL CHARACTERISTICS

Capacitance 100Hz +20°C (μF)	Case (code)	Type	Max. leakage current			Max. DF +20°C (%)	Type	Max. leakage current			Max. DF +25°C (%)
			+20°C (μA)	+85°C (μA)	+125°C (μA)			+25°C (μA)	+85°C (μA)	+125°C (μA)	
Rated voltage (+85°C) 100 V - Category voltage (+125°C) 63 V											
0,1	A	CTS1	1	1	1,2	6	CTS1M	0,3	5	6,3	2
0,12	A	CTS1	1	1,2	1,5	6	CTS1M	0,3	5	6,3	2
0,15	A	CTS1	1	1,5	1,8	6	CTS1M	0,3	5	6,3	2
0,18	A	CTS1	1	1,8	2,2	6	CTS1M	0,3	5	6,3	2
0,22	A	CTS1	1	2,2	2,7	6	CTS1M	0,3	5	6,3	2
0,27	A	CTS1	1	2,7	3,3	6	CTS1M	0,3	5	6,3	2
0,33	A	CTS1	1	3,3	4,1	6	CTS1M	0,3	5	6,3	2
0,39	A	CTS1	1	3,9	4,8	6	CTS1M	0,3	5	6,3	2
0,47	A	CTS1	1	4,7	5,8	6	CTS1M	0,3	5	6,3	2
0,56	A	CTS1	1	5,6	7	6	CTS1M	0,3	5	6,3	2
0,68	B	CTS1	1	6,8	8,5	6	CTS1M	0,3	5	6,3	2
0,82	B	CTS1	1	8,2	10	6	CTS1M	0,4	5	6,3	2
1	B	CTS1	1	10	12	6	CTS1M	0,5	5	6,3	2
1,2	B	CTS1	1,2	12	15	6	CTS1M	0,5	5	6,3	4
1,5	B	CTS1	1,5	15	18	6	CTS1M	0,7	10	13	4
1,8	B	CTS1	1,8	18	22	6	CTS1M	0,7	10	13	4
2,2	B	CTS1	2,2	22	27	6	CTS1M	0,9	15	19	4
2,7	B	CTS1	2,7	27	33	6	CTS1M	1,1	15	19	4
3,3	C	CTS1	3,3	33	41	6	CTS1M	1,5	30	38	6
3,9	C	CTS1	3,9	39	48	6	CTS1M	1,5	30	38	6
4,7	C	CTS1	4,7	47	58	6	CTS1M	2,5	50	63	6
5,6	C	CTS1	5,6	56	70	6	CTS1M	2,5	50	63	6
6,8	C	CTS1	6,8	68	85	6	CTS1M	2,5	50	63	6
8,2	D	CTS1	8,2	82	102	6					
10	D	CTS1	10	100	125	6					
Rated voltage (+85°C) 125 V - Category voltage (+125°C) 80 V											
0,1	A	CTS1	1	1,2	1,5	6					
0,12	A	CTS1	1	1,5	1,8	6					
0,15	A	CTS1	1	1,8	2,3	6					
0,18	A	CTS1	1	2,2	2,8	6					
0,22	A	CTS1	1	2,7	3,4	6					
0,27	A	CTS1	1	3,3	4,2	6					
0,33	A	CTS1	1	4,1	5,1	6					
0,39	B	CTS1	1	4,8	6	6					
0,47	B	CTS1	1	5,8	7,3	6					
0,56	B	CTS1	1	7	8,7	6					
0,68	B	CTS1	1	8,5	10	6					
0,82	B	CTS1	1	10	12	6					
1	B	CTS1	1,2	12	15	6					
1,2	B	CTS1	1,5	15	18	6					
1,5	B	CTS1	1,8	18	23	6					
1,8	B	CTS1	2,2	22	28	6					
2,2	B	CTS1	2,7	27	34	6					
2,7	C	CTS1	3,3	33	42	6					
3,3	C	CTS1	4,1	41	51	6					
3,9	C	CTS1	4,8	48	60	6					
4,7	C	CTS1	5,8	58	73	6					
5,6	C	CTS1	7	70	87	6					
6,8	C	CTS1	8,5	85	106	6					
8,2	D	CTS1	10,2	102	128	6					
10	D	CTS1	12,5	125	156	6					

Electrical characteristics

CAPACITANCE

The capacitance is defined by a rated value (C_R , indicated on the capacitor) and a tolerance (generally $\pm 20\%$).

The capacitance is measured for most of the types at a 100Hz frequency (1 kHz for CTS21 - CTS21E - CTC21 - CTC21E) under a 0,1 to 1 V_{AC} voltage and a 2,1 to 2,5 V bias.

At room temperature, it must be in the range defined by the rated value and the tolerance.

Capacitance change vs applied DC voltage: negligible

CAPACITANCE CHANGE VS FREQUENCY: STANDARD TYPES

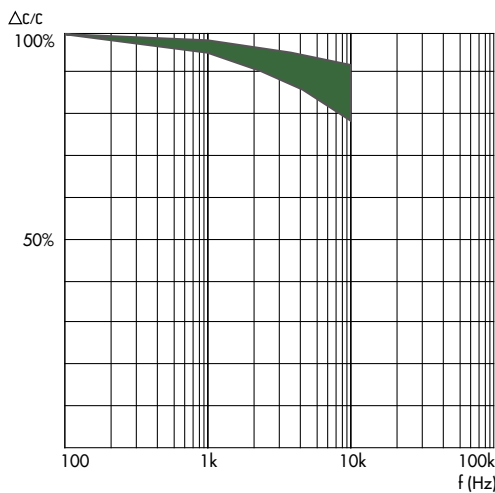

CAPACITANCE CHANGE VS TEMPERATURE: STANDARD TYPES

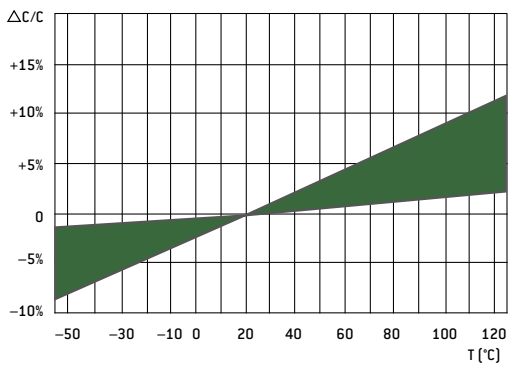

CAPACITANCE CHANGE VS FREQUENCY: CTC21 AND CTS21

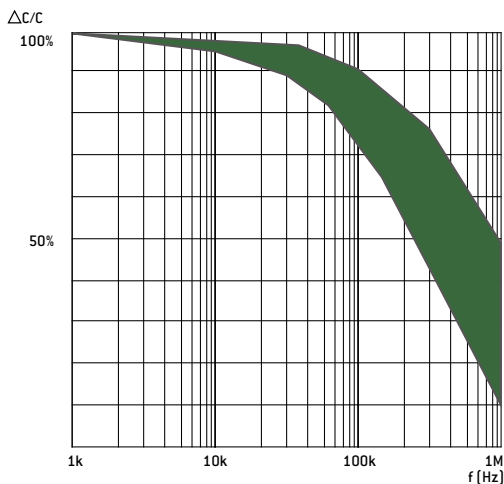

CAPACITANCE CHANGE VS TEMPERATURE: CTC21 AND CTS21

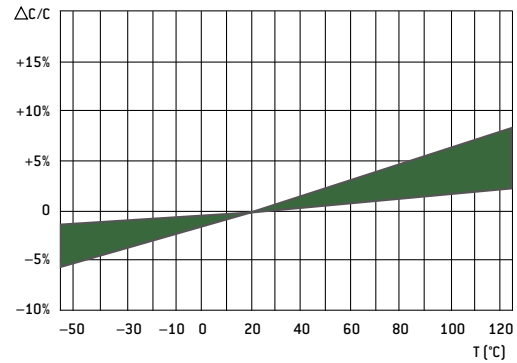

See typical curves below. Maximum changes are given, for each type, on the data sheets.

TOLERANCE (ON RATED CAPACITANCE)

It defines, with the rated capacitance, the range in which the capacitance value must be at room temperature

e.g.: Rated capacitance: 100μF
Tolerance: 20%
The measured capacitance must be between:
 $100 \cdot (20\% \text{ of } 100) = 80$ and $100 + (20\% \text{ of } 100) = 120$
The standard tolerance for tantalum capacitors is 20%.

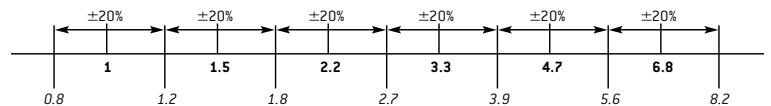

DIRECT DC VOLTAGE

The **rated voltage (U_R)**, indicated on the capacitor, is the maximum DC voltage which can be applied continuously between -55°C and $+85^\circ\text{C}$.

For the types which can be used up to 125°C , the voltage must be derated between $+85^\circ\text{C}$ and $+125^\circ\text{C}$ according to the following curve.

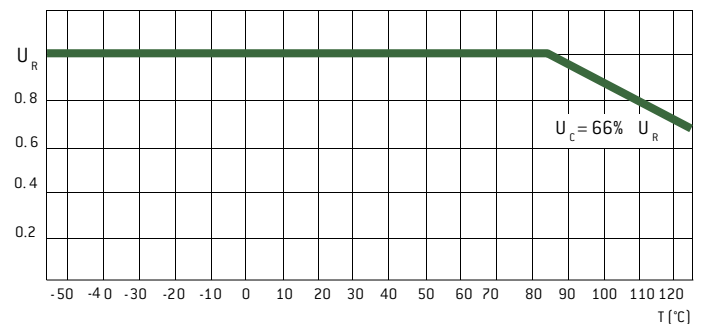

The **category voltage (U_C)** is consequently the maximum DC voltage which can be applied continuously at $+125^\circ\text{C}$.

The **surge voltage** is the maximum voltage which can be applied for short periods.

It is given for each type in the data sheet and is generally equal to 1,3 times U_R between -55°C and $+85^\circ\text{C}$ and 1,3 times U_C at $+125^\circ\text{C}$.

Tests are performed with charging periods of 30 seconds, through a 1000 Ω resistor, and discharging periods of 5 min 30 s. 1000 cycles are done.

Electrical characteristics

REVERSE VOLTAGE

This characteristic is not guaranteed for all types (see data sheets).

MAXIMUM REVERSE VOLTAGE IS GENERALLY:

- 0,15 times U_R at +20°C
- 0,05 times U_R at +85°C
- 0,01 times U_R at +125°C

TESTS ARE PERFORMED WITH THE FOLLOWING CONDITIONS:

125 hours under Reverse voltage followed by 125 hours under direct voltage.

LEAKAGE CURRENT

Leakage current is the residual current which flows through the capacitor after the charging time, under rated voltage. It is measured after a time not exceeding 5 minutes and is given in μA.

It is equivalent to the insulation resistance of the capacitor and it must be as low as possible.

Maximum leakage current is a function of capacitance and rated voltage values and is given, for each type, in the data sheets.

AT 20°C, THE LIMIT IS GENERALLY:

Lc Max. (μA) = 0,01 x C_R x U_R with C_R in μF and U_R in V.

LEAKAGE CURRENT CHANGE VS APPLIED VOLTAGE

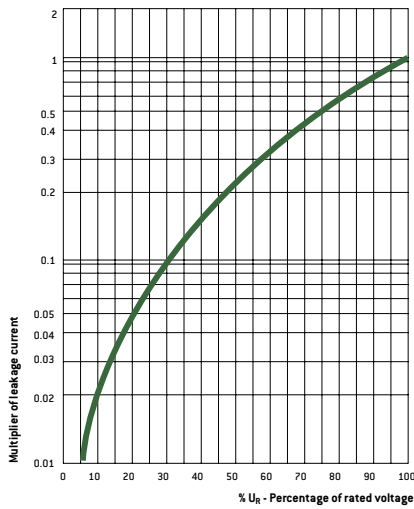

LEAKAGE CURRENT CHANGE VS TEMPERATURE

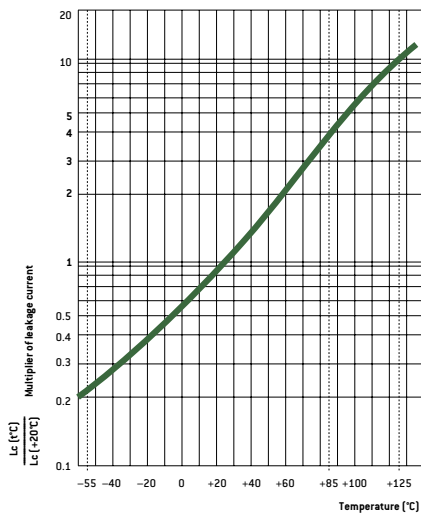

DISSIPATION FACTOR

Dissipation factor is generally measured at the same time as the capacitance (at 100Hz or 1kHz depending on the model), with the same conditions. It is a function of the series resistance of the capacitor and the capacitance at low frequency.

$$DF = ESR \times C \times 2 \pi f$$

At low frequency, the series resistance is the sum of an ohmic part (leads, contacts, MnO₂) and the dielectric losses.

Dissipation factor is given in % and maximum limits are given for each type in the data sheets.

DISSIPATION FACTOR CHANGE VS TEMPERATURE

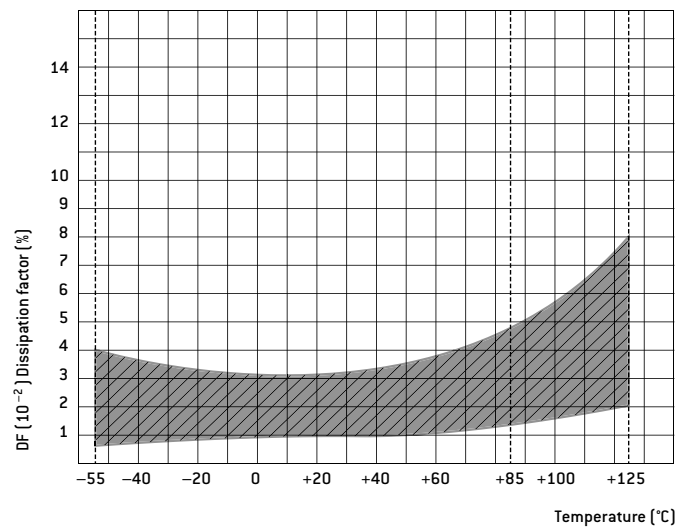

DISSIPATION FACTOR CHANGE VS FREQUENCY

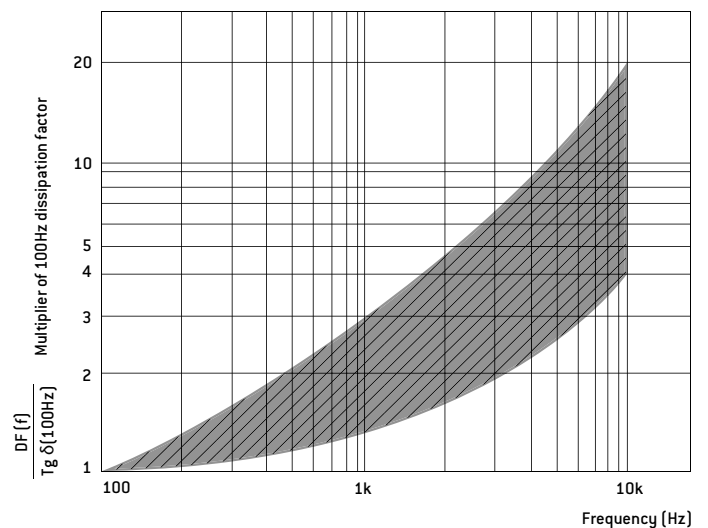

Electrical characteristics

EQUIVALENT SERIES RESISTANCE OR IMPEDANCE

Equivalent circuit of a capacitor

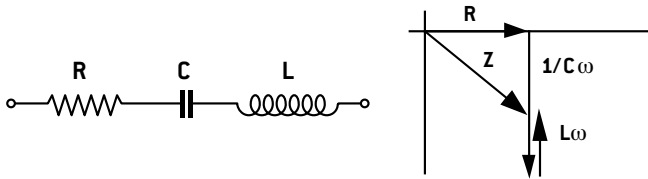

- R:** equivalent series resistance of the capacitor (leads, contacts, MnO₂, dielectric losses)
- L:** inductance mainly due to the leads
- C:** capacitance

Equivalent Series Resistance for

CTS21	CTC21	CTC4	CTS41ESR	CTC42	CTP21
CTS21E	CTC21E	CTC4 RSE		CTC42E	CTP42

For these types which are specially designed to be used in power supplies and converters, a maximum ESR is given at a frequency of 100kHz or 500 kHz. Parameters such output ripple voltage and ripple current capability are directly a function of the ESR value.

Maximum ESR: see data sheets.

Impedance (for standard products)

For the others types, a maximum limit is given for the impedance. The formula for impedance is:

$$Z = \sqrt{R^2 + (L\omega - 1/C\omega)^2}$$

Examples of impedance curves vs frequency are given in the following pages.

It can be seen that:

- at low frequencies, impedance is a function of capacitance
- at high frequencies, impedance is a function of inductance
- at medium frequencies, it is a function of the ESR

Maximum impedance: see data sheets.

ESR CHANGE VS TEMPERATURE

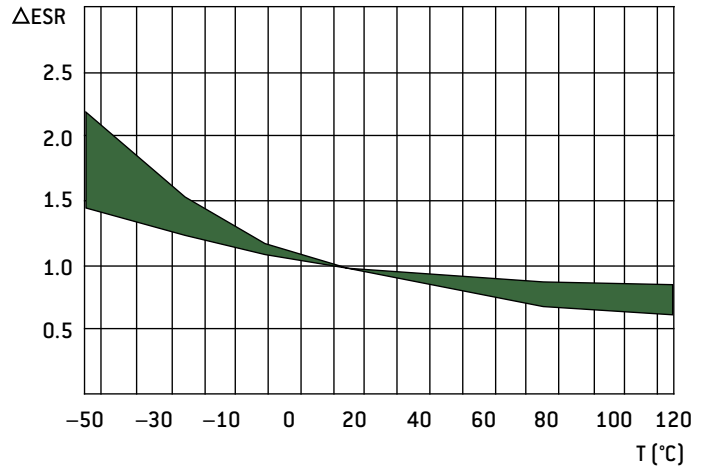

ESR CHANGE VS FREQUENCY

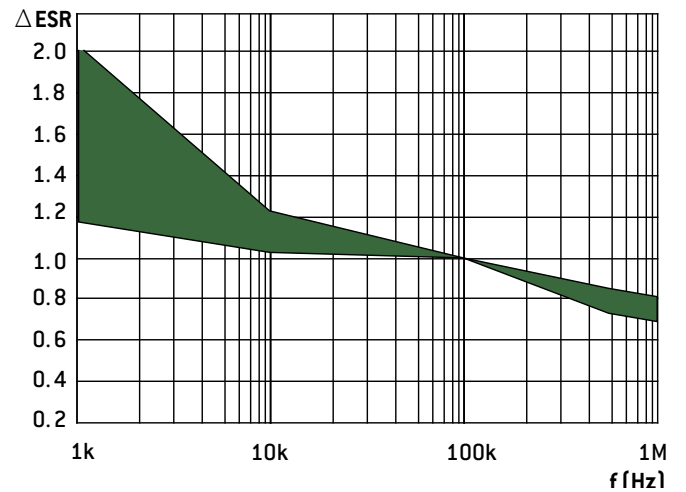

Electrical characteristics

CTS1 TYPE

Impedance (Ohms)

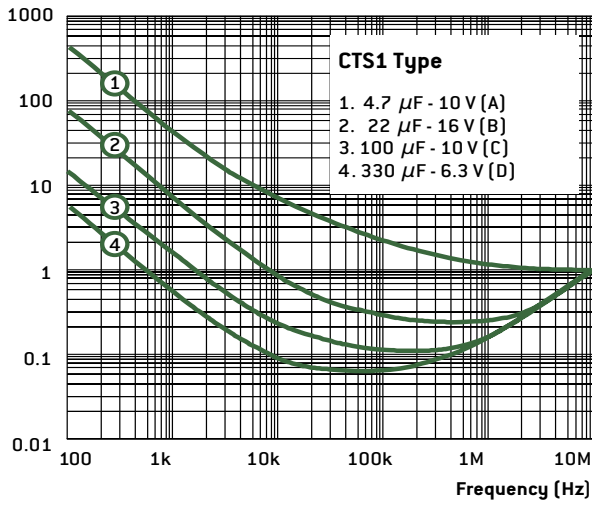

CTS27 TYPE

Impedance (Ohms)

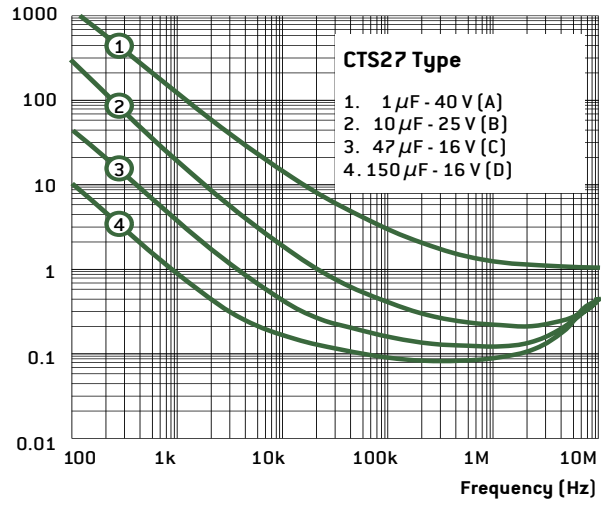

CTS4 TYPE

Impedance (Ohms)

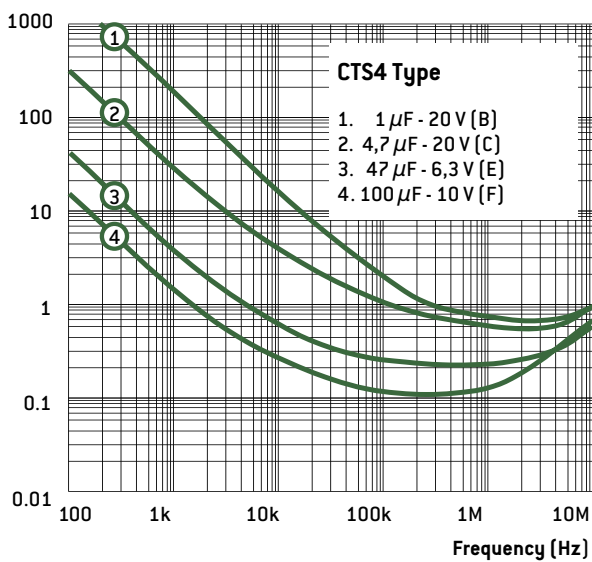

CTC3 TYPE

Impedance (Ohms)

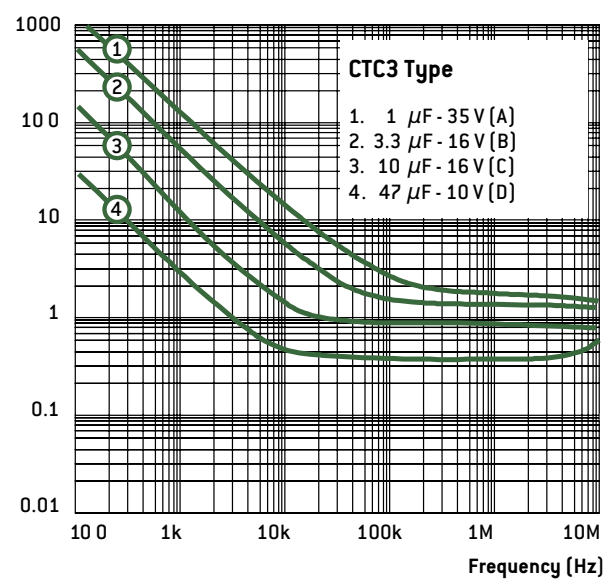

CTS21 TYPE CASE C

Impedance (Ohms)

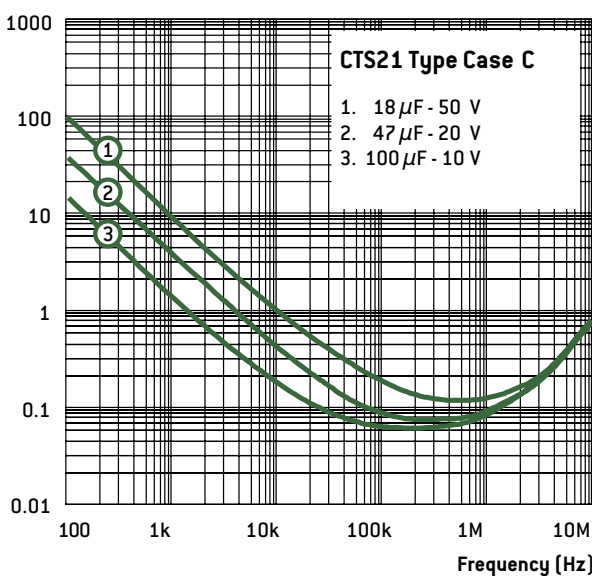

CTS21 TYPE CASE D

Impedance (Ohms)

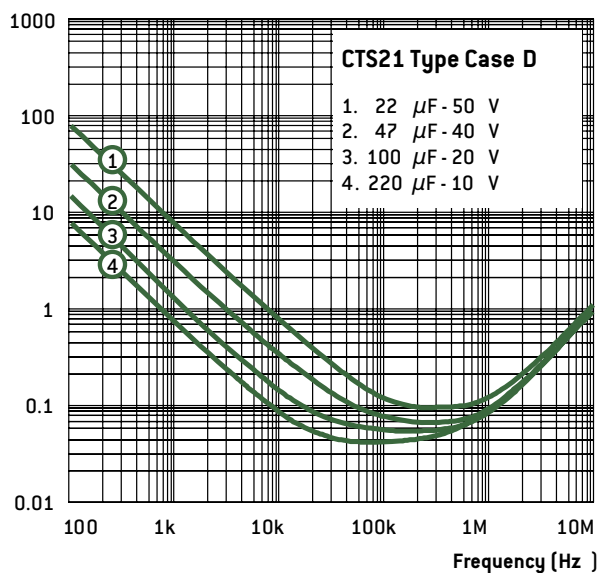

Electrical characteristics

CTS21E TYPE CASE C

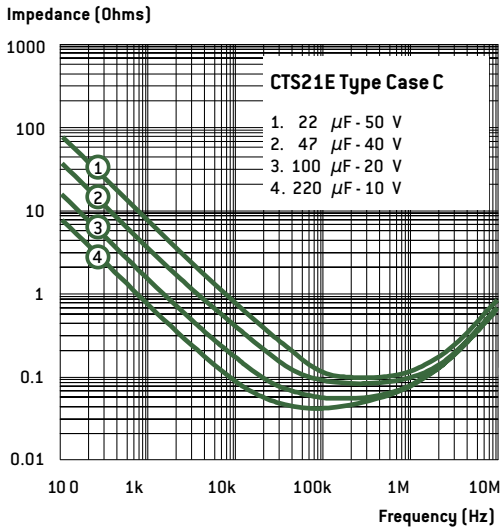

CTS21E TYPE CASE D

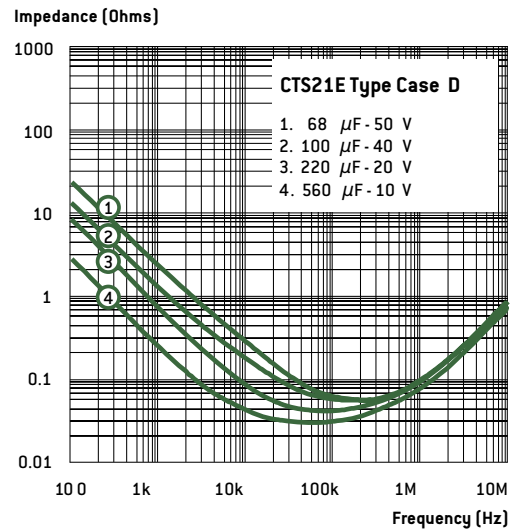

CTC21 TYPE CASE C

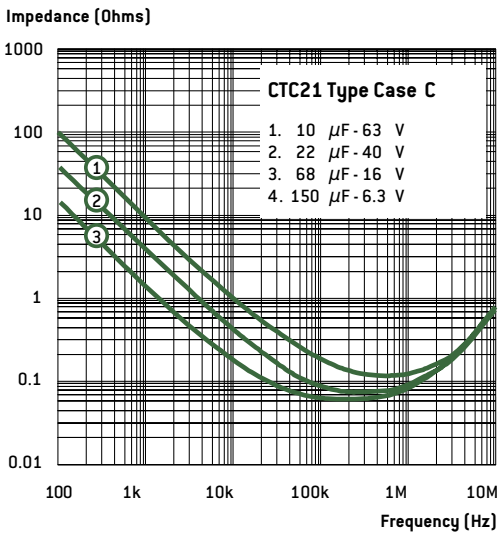

CTC21 TYPE CASE D

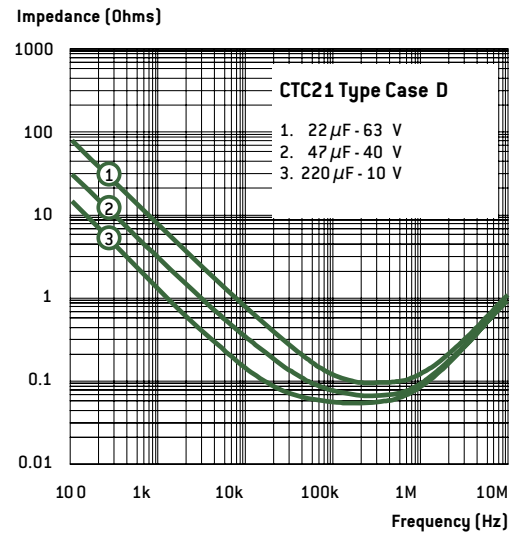

CTC21E TYPE CASE C

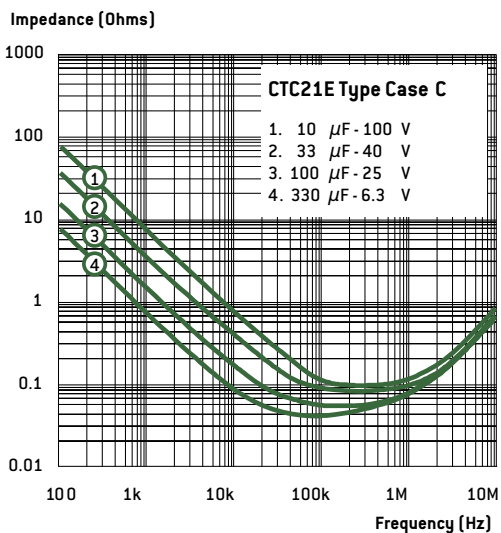

CTC21E TYPE CASE D

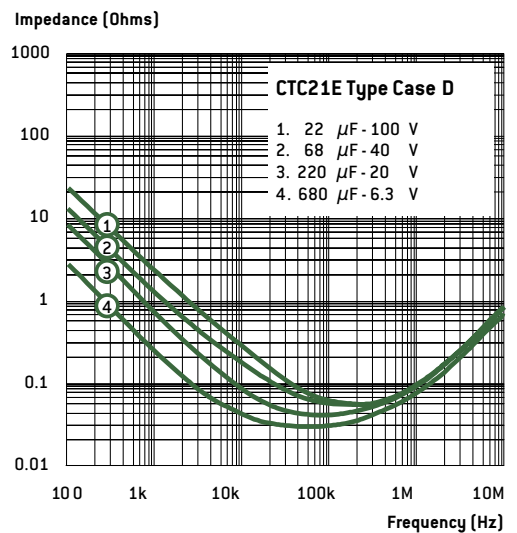

Electrical characteristics

MAXIMUM RIPPLE CURRENT - MAXIMUM RIPPLE VOLTAGE

The maximum value of the ripple current, or ripple voltage which can be applied to the capacitor is only limited by the thermal effect. Indeed, as the electrolyte is in this case a solid semi-conductor, there is no damage and physical change in the structure when a ripple current is flowing through it.

On the other hand, as the series resistance is not zero, there will be a heating which is proportional to the ESR and to the square of ripple current [$P = ESR \times I_{rms}^2$]

Types

CTS21	CTC21	CTC4	CTS41 RSE	CTC42	SMT47
CTS21E	CTC21E	CTC4 RSE		CTC42E	

For these products, for which a maximum ESR is given, the maximum ripple current is also given in the data sheets. This value has been calculated with the maximum ESR values and a maximum dissipated power per case size.

As the ESR changes in frequency, maximum ripple currents are given for two frequencies (1kHz and 100kHz). For other frequencies, apply the rule given by the curve below.

COEFFICIENT APPLY TO THE MAXIMUM RIPPLE CURRENT VS TEMPERATURE

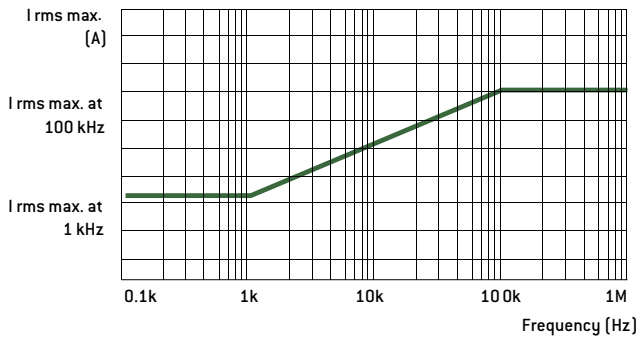

As there is heating due to the ripple current, it is also necessary to derate the maximum ripple current when the room temperature is higher than 20°C:

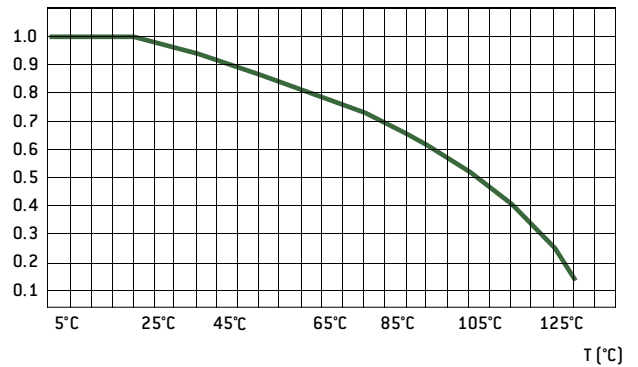

TYPICAL HEATING OF THE CASE VS DISIPATED POWER

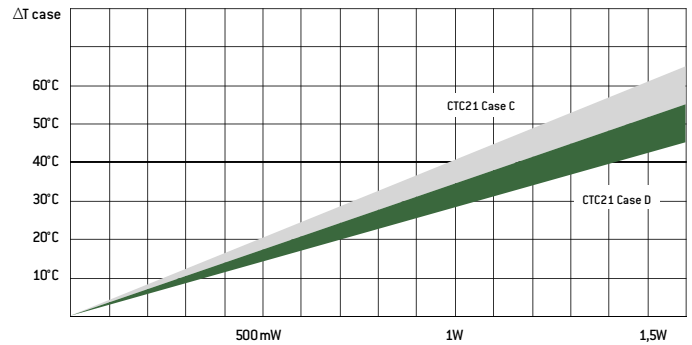

Electrical characteristics

OTHERS TYPES

The same rule will be used to calculate the maximum ripple voltage:

$$I_{rms\ Max.} = \sqrt{(P_{max}/ESR_{max})}$$

MAXIMUM DISSIPATED POWER WILL BE CHOSEN AS FOLLOW:

Metal cases (CTS1, CTS13, CTS23, CTS33, ...)

- case A : 0,090 W
- case B : 0,100 W
- case C : 0,125 W
- case D : 0,180 W

Plastic cases (CTS27)

- case A : 0,080 W
- case B : 0,090 W
- case C : 0,100 W
- case D : 0,125 W

SMD cases (CTC3, CTC3E, ...)

- case A : 0,075 W
- case B : 0,085 W
- case C : 0,110 W
- case D : 0,150 W
- case S : 0,060 W
- case T : 0,070 W
- case U : 0,090 W
- case V : 0,0125 W

These values should be derated at elevated temperature as follows

at +85°C: 0,9

at +125°C: 0,4

For maximum values of ESR, it will be possible to use the maximum impedance value given at 100kHz or to measure the ESR of capacitors.

Maximum ripple voltage can be calculated with the value of maximum ripple current and the following formula

$$U_{rms} = Z \text{ [impedance]} \times I_{rms}$$

NOTE FOR ALL TYPES

In addition to the requirements due to thermal effects, maximum ripple currents and voltages will be limited by the following parameters:

- the sum of DC voltage and positive peak of AC voltage must be less than maximum allowable direct voltage of the capacitor.
- the negative peak of AC voltage will not create a voltage exceeding maximum allowable Reverse voltage.

9 - CHARGE DISCHARGE / SURGE CURRENT

For standard types of solid tantalum capacitors, it is necessary to limit the surge current by placing a resistance in series with the capacitor. The value of this resistance will be calculated by using the rule of 3Ω per volt (I_{Max.} = 0,33 A).

However, some more recent types can be used without any limit on the surge current; these types are registered with the reference «high surge current» (eg : CTS32, CTS23, CTS33, CTS21, CTS21E, CTS41, CTS41ESR, CTC4, CTC4 RSE, CTC21, CTC21E, CTC42, CTC42E, SMT47).

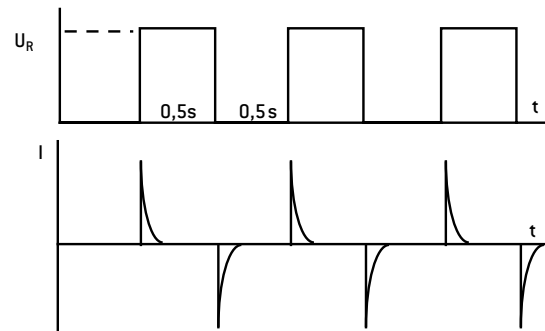
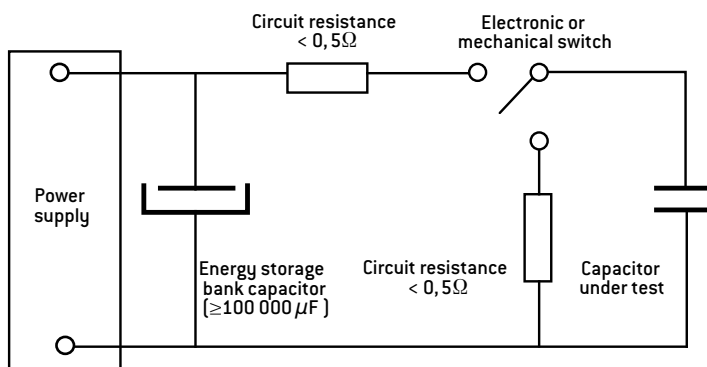

The high surge current test is performed to check that these capacitors can be used in low impedance circuits, and to make sure of their capability to withstand high surge currents.

The test being performed under rated voltage with a maximum 0,5 Ω circuit resistance, the peak surge current will be a minimum equal to $I_p = U_R / 0,5$ (if the ESR of the capacitor is considered as negligible).

e.g.: high surge current test performed on a CTS21 100μF-20 V (ESR=75mΩ, negligible compared to 0,5Ω) Surge current = $20/0,5 = 40$ A during a few tens of μs.

Depending upon the types, this test can be 100% performed or on a sampling basis, during 3 to 5 cycles. During periodic tests, 1 million cycles are performed.

General characteristics

CLIMACTIC CHARACTERISTICS

1- CLIMATIC CATEGORY

Climatic category defines the temperature range over which the capacitor can be used continuously, and also the number of days for the damp heat test (this test is performed periodically at 40°C with a 93% moisture rate).

Note: for types with a climatic range of -55°C to +125°C, it is necessary to derate the voltage for temperatures higher than 85°C (see page 84).

2- THERMAL SHOCKS - RAPID CHANGES OF TEMPERATURE

This test is performed to check that the capacitors can withstand sudden temperature changes. The method which is used is the one with two chambers, one at -55°C, the other one at +85°C or +125°C, depending upon the types. Five cycles are performed, with 30 min at low temperature and 30 min at high temperature, during the periodic tests or on 100% of the batch. Electrical characteristics are measured after this test.

3 - DAMP HEAT TEST

This test is performed during the periodical test, with the following conditions:

Temperature: 40°C	DC voltage: without
Humidity: 90 to 95%	Time: 21 or 56 days

Electrical characteristics are measured after this test.

MECHANICAL CHARACTERISTICS

1 - VIBRATIONS

This test is performed during the periodical test, with the following conditions:

Metal cases

- Method B4
- Frequency: 10 to 2000Hz
- Amplitude: 1,5 mm or 196 m/s²
- Time: 6 hours

Plastic cases: CTS4 or CTS41 Type

Same conditions, except:

- Amplitude 0,75 mm or 98 m/s²

Plastic cases: CTS27 Type

Same conditions, except:

- Frequency: 10 to 55Hz
- Amplitude: 1,5 mm or 98 m/s²

2 - SHOCKS

This test is performed just after the vibrations test, with the following conditions for all types:

- Acceleration: 981 m/s²
- Pulse width: 6 ms
- Shape: 1/2 sinewave
- Number of shocks: 3 for each of the 3 directions

RELIABILITY - LIFE TIME

1 - RELIABILITY

Reliability of a component can be defined as its probability to work without any failure, in defined conditions and during a fixed time.

Reliability is not therefore only a function of the component quality, but also of the application and environmental conditions.

The parameter which is the most commonly used for the reliability is the failure rate in time, generally expressed in % per 1000 hours.

1-1 ESTABLISHED FAILURE RATE CAPACITORS (CTS1M)

This types, equivalent to MIL types, can be supplied with a fixed failure rate. This failure rate is coded with the following letters:

M = 1.0 % / 1000 h
P = B = 0.1% / 1000 h
R = C = 0.01% / 1000 h
S = D = 0.001% / 1000 h

For EXXELIA, the rate is calculated by recording the failures during the burn-in and according to the Weibull method.

The desired failure rate code letter must be added just after the type reference (ie: CTS1MC = CTS1M with a failure rate of 0.01% / 1000 hours).

1-2 CALCULATION OF A COMPONENT FAILURE RATE USED IN AN EQUIPMENT

The calculation method on the next page uses parameters which are given by the CNET (Centre National d'Étude des Télécommunications) in its Reliability Data Book (RDF 1993).

The failure rate is calculated with parameters which are function of the capacitor (capacitance, case type, approvals, high surge current test) and others ones which are representative of application conditions (voltage, temperature, resistance in series, environmental conditions).

Example: CTS21E 150µF-25 V used under 12 volts, at 40°C, without serie resistance, in a satellite in orbit:

$$\pi_t = 1,2 \quad \pi_v = 1,38 \quad \pi_R = 1 \quad \pi_B = 1$$

$$\pi_C = 1,8 \quad \pi_E = 0,5 \quad \pi_q = 1$$

$$\lambda = 4 \times 1,2 \times 1,38 \times 1 \times 1 \times 1,8 \times 0,5 \times 1 \cdot 10^{-9}/h$$

$$= 6 \cdot 10^{-9}/h = 0,0006 \% \text{ defect}/1000 \text{ hours}$$

2 - LIFE TIME

There is no known damaging mechanism in time for solid tantalum capacitors; that is why it is difficult to give a precise life time.

However, life tests at 85°C under rated voltage and 125°C under derated voltage are periodically performed.

In addition, during qualification programs for new types, life test at 85°C and 125°C have been performed during 10000 hours and no significant parameter change have been observed.

General characteristics

π_t = TEMPERATURE INFLUENCE

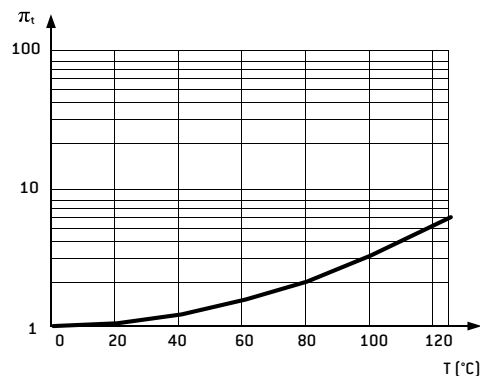

Formula: $\pi_t = \exp [1,8 \cdot (t / t_m)^2]$

with: t = using temperature
t_m = maximum temperature
Curve for t_m = 125°C

π_v = INFLUENCE OF APPLIED VOLTAGE VS RATED VOLTAGE

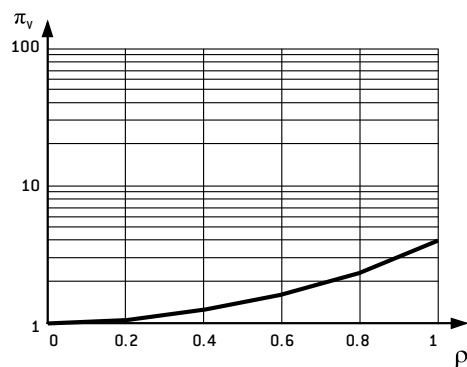

Formula: $\pi_v = \exp [(\rho / 0,85)^2]$

$\rho = \frac{\text{peak voltage}}{\text{rated voltage}}$

Curve $\pi_v = f(\rho)$

π_R = INFLUENCE OF CIRCUIT RESISTOR IN SERIE

V = using voltage

R = circuit resistance between capacitor and power supply

1. Types with high surge current test: $\pi_R = 1$

2. Others types: π_R = function of R/V in /V

R/V ≥ 3	$\pi_R = 1$	R/V = 0,6	$\pi_R = 6$
R/V = 2	$\pi_R = 1,5$	R/V = 0,4	$\pi_R = 9$
R/V = 1	$\pi_R = 3$	R/V = 0,2	$\pi_R = 12$
R/V = 0,8	$\pi_R = 4,5$	R/V = 0,1	$\pi_R = 15$

π_E = INFLUENCE OF APPLICATION

Satellite in orbit	$\pi_E = 0,5$
Ground; stationary; protected	$\pi_E = 1$
Ground; stationary; non protected	$\pi_E = 2,5$
Ground; mobile; soft conditions	$\pi_E = 4$
Aircraft; soft conditions	$\pi_E = 4$
Ship; soft conditions	$\pi_E = 4$
Ground; mobile; hard conditions	$\pi_E = 5,5$
Ship; hard conditions	$\pi_E = 7$
Aircraft; hard conditions	$\pi_E = 10$
Satellite launching	$\pi_E = 12$

π_B = INFLUENCE OF CASE TYPE

Metal case	$\pi_B = 1$
Molded case	$\pi_B = 3$
Dipped	$\pi_B = 5$

π_C = INFLUENCE OF CAPACITANCE

0,1μF	$\pi_C = 0,75$
150μF	$\pi_C = 1,8$
330μF	$\pi_C = 2$
1000μF	$\pi_C = 3$

π_q = INFLUENCE OF QUALIFICATION

Products approved to CECC	$\pi_q = 1$
Others products	$\pi_q = 1$

Axial leads - General characteristics

Applicable for types see below:

General purpose: CTS1, CTS13, CTS32, CTS1M

Extended ranges: CTS23, CTS33

Special for power supplies and converters: CTS21, CTS21E

CONSTRUCTION

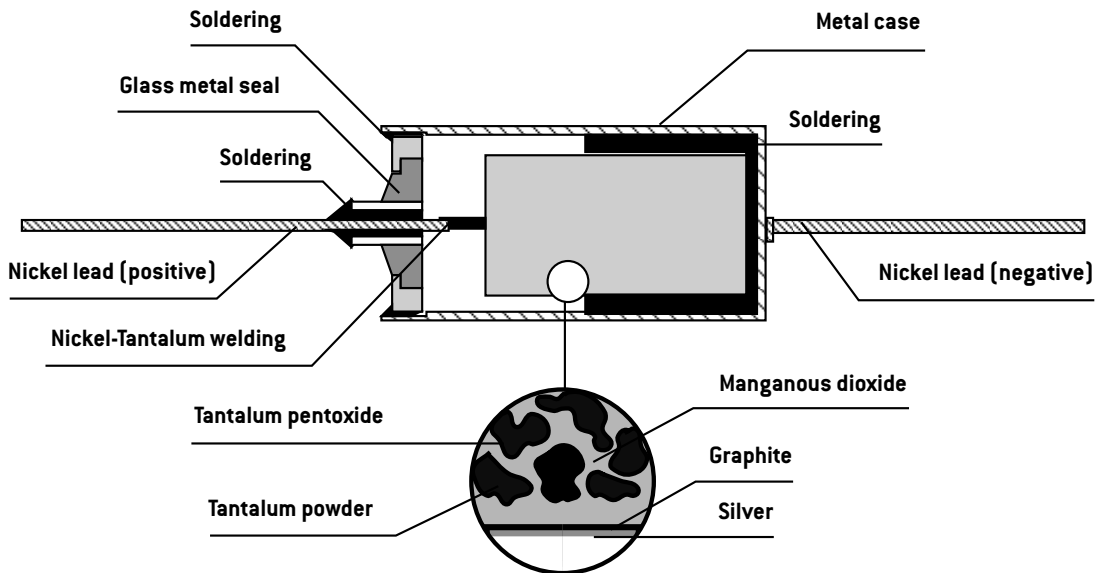

MARKING

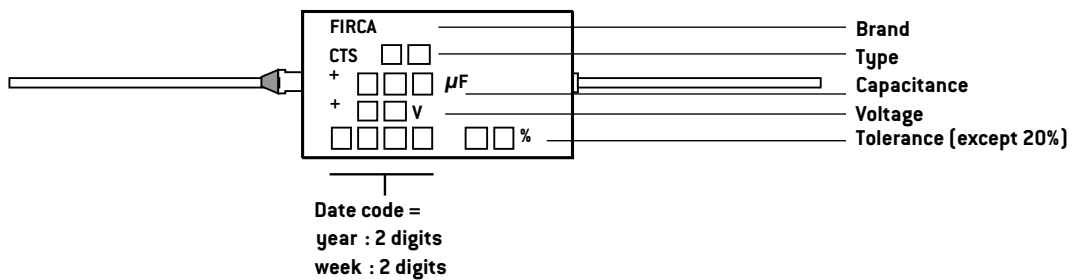

PACKAGING

Depending upon the quantities, there will be different types for packaging:

- Loose in plastic bags or boxes
- Taped in plastic bags
- Taped on reel

Dimensions about taping and reels are given on the next page.

Axial leads - Tape & Reel Packaging

LENGTH OF THE CAPACITOR

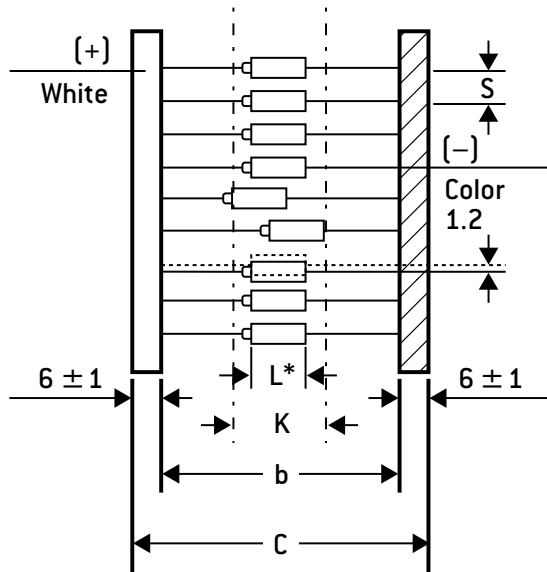

TAPE DIMENSIONS (in mm)

Case code	L max.	K max.	* $b \pm 2$	C max.	** $S \pm 0,5$	Qty per reel Std/max.
A	8,1	9,5	53	70	5	3500
B	12,8	14,2	53	70	5	2500
C	18,2	18,2	73	90	10	500
D	20,8	20,8	73	90	10	400

* The size b of 53 mm for B case is the standard dimension.

** Max. cumulative tolerance on 10 capacitors: ± 2 mm

REEL SIZE (in mm)

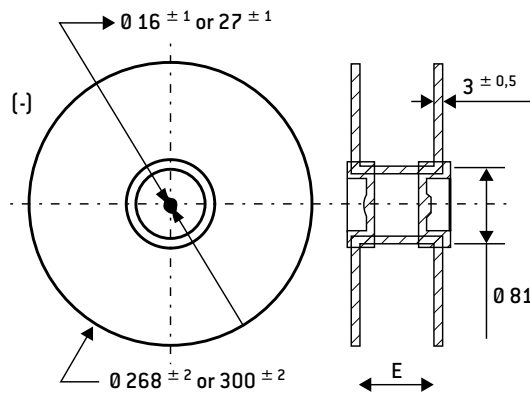

Size E of reels according to case sizes.

EA = 67

B = 67

C-D = 87

General information

Tantalum capacitors are, with ceramic, aluminum and film capacitors, one of the most used family.

The manufacturing technology and the constant improvements in tantalum powders allow it to be the capacitor with the highest CV (product capacitance x voltage) per volume, very long life and high reliability.

It has also the following advantages:

- Wide range of capacitance (less than $1\mu\text{F}$ to more than $10\,000\mu\text{F}$)
- Wide operating temperature range (-55°C to $+200^{\circ}\text{C}$)
- Electrical characteristics stable with temperature
- Low leakage current
- Very low ESR for some types
- Stability after long periods of storage, without any reforming

All these characteristics allow tantalum capacitors to be commonly used either in large volume markets like mobile phones or computers, or in specific High-Rel applications such as space, aerospace and military.

Its main uses are found in the following functions:

- Filtering
- Bypass
- Coupling
- RC time constant
- Energy storage

Tantalum capacitors can be divided into two main families and several sub-families:

Solid tantalum capacitors:

- Solid MnO_2
 - Metal cases
 - Molded cases
 - SMD
- Solid Polymer
 - SMD

Wet tantalum capacitors:

- Silver cases
- Tantalum cases

HOW TO USE THE SELECTION GUIDE

- 1 - The **Technical Selection Guide** can be used to select a product according to the main technical requirements.
- 2 - The **Classification according to specification** makes the link between all major standard specifications and the products.
- 3 - The **Selection Guide** by family has the same classification as in the catalogue. You will find for each type the main features, the approvals and the page number of the technical data sheet.

MANUFACTURING

ANODE AND INSULATOR

Tantalum capacitors are the capacitors which have the highest ratio of capacitance per volume. This is mainly due to the high dielectric coefficient of its insulator and to its large cross-section.

The basic raw material is a high purity (greater than 99,99%) tantalum powder with a very fine granulation, compressed to form a cylinder or a parallelepiped constituting the anode of the capacitor (positive plate).

The pellet is then sintered at high temperature (1200°C to 2200°C), under high vacuum (10^{-6} Torr), firstly to purify the powder and secondly to obtain a strong mechanical structure by a welding of the particles.

The insulating part is obtained by anodization to a depth of the tantalum surface which forms a tantalum pentoxide film (Ta_2O_5) with a thickness of about 16 angstroms per anodization volt. The dielectric coefficient is between 21 and 27 depending upon the anodization conditions.

WET ELECTROLYTE: CATHODE AND ENCAPSULATION

In this case, the cathode is formed by a sulphuric acid solution. The anodized tantalum pellet is impregnated with this solution and then placed in a silver or tantalum case, into which some equivalent gelled solution have been previously deposited.

The case is then crimped on the internal PTFE gasket to make the sealing. The final steps are welding (CT79), soldering (CT9) or elastomer seal (CT4) depending on the capacitors.

SOLID ELECTROLYTE: CATHODE AND ENCAPSULATION

In this case, the cathode is formed either by manganous dioxide which is a grey semi conductor or by polymer solution.

Solid MnO_2 cathode is obtained by dipping the pellets into a manganous nitrate water solution which impregnates the internal structure; this solution is then decomposed in a high temperature oven to obtain manganous dioxide. This operation is repeated several times. The nature and quality of this semiconductor are important to some of the electrical parameters (especially the serial resistance).

To finish the negative plate, a graphite coating and then a silver coating are deposited on the outside surface of the manganous dioxide or conducting polymer.

The positive nickel lead is welded on the tantalum wire and the negative lead is either soldered for the products with axial leads or glued with a silver epoxy for the SMD range.

BURN-IN - SORTING - INSPECTION

All the products are submitted to a final burn-in, with differing severities depending upon the characteristics of each type (temperature, voltage, duration).

Then follows the sorting, marking and inspection operations. It can be noted that the procedures for these operations are the same for approved and non approved parts (except the periodical tests).

General information

TYPE IDENTIFICATION - ORDERING INFORMATION

THE COMPLETE IDENTIFICATION OF A PRODUCT IS MADE OF

- The type (or model)
- The tolerance
- The case size
- The rated voltage
- The rated capacitance
- If applicable the CECC specification number

THE TYPE

It can be expressed with the commercial description (CTC21E C 33 μ F 10% 40V) or the **EXXELIA** part number (TS22EC336K040F).

When applicable the CECC specification number should be indicated.

THE CASE SIZE

It is indicated on the technical data sheets in front of each capacitance-voltage value and is generally identified by a letter code. It is important to give this information because there can be, for the same type, a standard range and an extended range in which the same value will be available in two different sizes.

THE RATED CAPACITANCE

It can be expressed:

- Directly in μ F (eg: 47 μ F)
- Coded according to MIL specification, with:
 - 2 digits number for the value
 - A multiplying factor to obtain the capacitance in pF (power of 10)

Eg: 567 = 56.10⁷ pF = 560 μ F

THE TOLERANCE

It can be expressed directly in % or identified by a code letter:

M = \pm 20%

K = \pm 10%

J = \pm 5%

N.B.: the standard tolerance for tantalum capacitors is 20%; if no tolerance is specified, it would be considered as 20%.

A 20% tolerance means in fact -20% to +20%.

THE RATED VOLTAGE

It is expressed directly in volts (V)

N.B.: 6,3V rated voltage can be coded as 6V.

CECC SPECIFICATIONS

Some of the products which are described in this catalogue are made to a CECC specification; these documents give in detail the following information for each type:

- The climatic, electrical and mechanical characteristics
- The test and inspection procedures
- The sampling methods and levels
- The tests periods

The reference specifications concerning the tantalum capacitors are the following:

CECC 30 000 (NFC 83-100)

Generic specification: fixed capacitors

- Terminology
- Quality Assessment Procedures
- Test and inspection methods

CECC 30 200 (NFC 83-112)

Sectional specification: tantalum capacitors

- Preferred characteristics
- Quality Assessment Procedures
- Test and inspection methods

CECC 30 201 XXX

Detail specifications solid tantalum capacitors

- Detailed characteristics for each type

CECC 30 202 XXX

Detail specifications wet tantalum capacitors

- Detailed characteristics for each type

CECC 30 800 (NFC 83-113)

Sectional specification: tantalum chip capacitors

- Preferred characteristics
- Quality Assessment Procedures
- Test and inspection methods

CECC 30 801 XXX

Detail specifications tantalum chip capacitors

- Detailed characteristics for each type
- The list of all the detail specifications is given in the selection guide, with the corresponding type.

NB: Some of the products refer to specifications which are no longer published.

OTHER SPECIFICATIONS

In addition to CECC approvals, some of the products are qualified to MIL standard M39006/22, M39006/25, DSCC DWG No. 93026 and some others are listed in ESA (European Space Agency) Preferred Parts Lists ESCC EPPL I or II.