

Tantalum Capacitors

Product Catalog

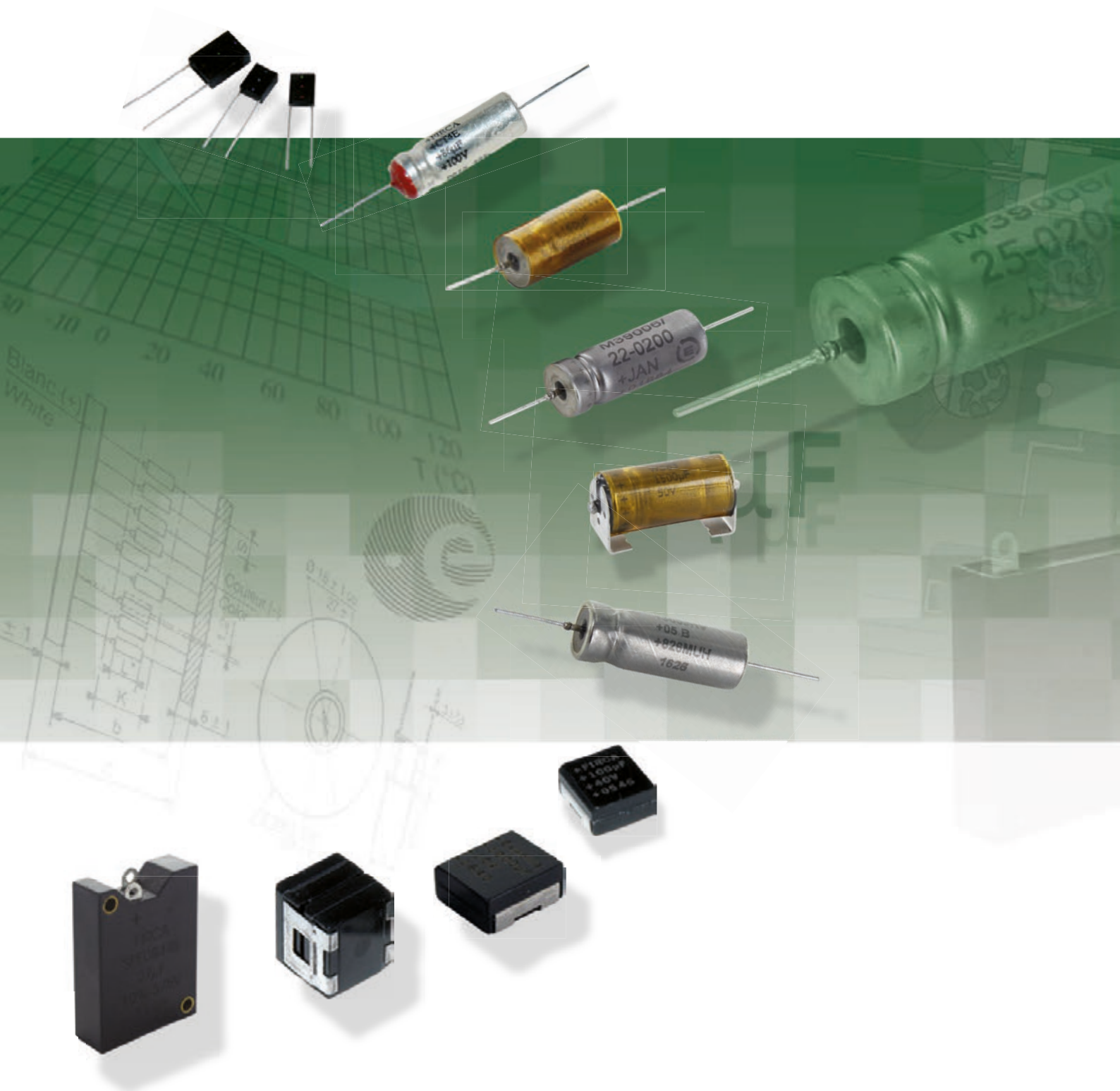

Tantalum Capacitors



A Worldwide presence



Specifications are subject to change without notice. All statements, information and data given herein are presented without guarantee, warranty or responsibility of any kind, expressed or implied.

General information

Tantalum capacitors are, with ceramic, aluminum and film capacitors, one of the most used family.

The manufacturing technology and the constant improvements in tantalum powders allow it to be the capacitor with the highest CV (product capacitance x voltage) per volume, very long life and high reliability.

It has also the following advantages:

- Wide range of capacitance (less than 1 μ F to more than 10 000 μ F)
- Wide operating temperature range (-55°C to +200°C)
- Electrical characteristics stable with temperature
- Low leakage current
- Very low ESR for some types
- Stability after long periods of storage, without any reforming

All these characteristics allow tantalum capacitors to be commonly used either in large volume markets like mobile phones or computers, or in specific High-Rel applications such as space, aerospace and military.

Its main uses are found in the following functions:

- Filtering
- Bypass
- Coupling
- RC time constant
- Energy storage

Tantalum capacitors can be divided into two main families and several sub-families:

Solid tantalum capacitors:

- Solid MnO₂
 - Metal cases
 - Molded cases
 - SMD
- Solid Polymer
 - SMD

Wet tantalum capacitors:

- Silver cases
- Tantalum cases

HOW TO USE THE SELECTION GUIDE

- 1 - The **Technical Selection Guide** can be used to select a product according to the main technical requirements.
- 2 - The **Classification according to specification** makes the link between all major standard specifications and the products.
- 3 - The **Selection Guide** by family has the same classification as in the catalogue. You will find for each type the main features, the approvals and the page number of the technical data sheet.

MANUFACTURING

ANODE AND INSULATOR

Tantalum capacitors are the capacitors which have the highest ratio of capacitance per volume. This is mainly due to the high dielectric coefficient of its insulator and to its large cross-section.

The basic raw material is a high purity (greater than 99,99%) tantalum powder with a very fine granulation, compressed to form a cylinder or a parallelepiped constituting the anode of the capacitor (positive plate).

The pellet is then sintered at high temperature (1200°C to 2200°C), under high vacuum (10⁻⁶ Torr), firstly to purify the powder and secondly to obtain a strong mechanical structure by a welding of the particles.

The insulating part is obtained by anodization to a depth of the tantalum surface which forms a tantalum pentoxide film (Ta₂O₅) with a thickness of about 16 angstroms per anodization volt. The dielectric coefficient is between 21 and 27 depending upon the anodization conditions.

WET ELECTROLYTE: CATHODE AND ENCAPSULATION

In this case, the cathode is formed by a sulphuric acid solution. The anodized tantalum pellet is impregnated with this solution and then placed in a silver or tantalum case, into which some equivalent gelled solution have been previously deposited.

The case is then crimped on the internal PTFE gasket to make the sealing. The final steps are welding (CT79), soldering (CT9) or elastomer seal (CT4) depending on the capacitors.

SOLID ELECTROLYTE: CATHODE AND ENCAPSULATION

In this case, the cathode is formed either by manganous dioxide which is a grey semi conductor or by polymer solution.

Solid MnO₂ cathode is obtained by dipping the pellets into a manganous nitrate water solution which impregnates the internal structure; this solution is then decomposed in a high temperature oven to obtain manganous dioxide. This operation is repeated several times. The nature and quality of this semiconductor are important to some of the electrical parameters (especially the serial resistance).

To finish the negative plate, a graphite coating and then a silver coating are deposited on the outside surface of the manganous dioxide or conducting polymer.

The positive nickel lead is welded on the tantalum wire and the negative lead is either soldered for the products with axial leads or glued with a silver epoxy for the SMD range.

BURN-IN - SORTING - INSPECTION

All the products are submitted to a final burn-in, with differing severities depending upon the characteristics of each type (temperature, voltage, duration).

Then follows the sorting, marking and inspection operations. It can be noted that the procedures for these operations are the same for approved and non approved parts (except the periodical tests).

General information

TYPE IDENTIFICATION - ORDERING INFORMATION

THE COMPLETE IDENTIFICATION OF A PRODUCT IS MADE OF

- The type (or model)
- The tolerance
- The case size
- The rated voltage
- The rated capacitance
- If applicable the CECC specification number

THE TYPE

It can be expressed with the commercial description (CTC21E C 33 μ F 10% 40V) or the **EXXELIA** part number (TS22EC336K040F).

When applicable the CECC specification number should be indicated.

THE CASE SIZE

It is indicated on the technical data sheets in front of each capacitance-voltage value and is generally identified by a letter code. It is important to give this information because there can be, for the same type, a standard range and an extended range in which the same value will be available in two different sizes.

THE RATED CAPACITANCE

It can be expressed:

- Directly in μ F (eg: 47 μ F)
- Coded according to MIL specification, with:
 - 2 digits number for the value
 - A multiplying factor to obtain the capacitance in pF (power of 10)

Eg: 567 = 56.10⁷ pF = 560 μ F

THE TOLERANCE

It can be expressed directly in % or identified by a code letter:

M = \pm 20%

K = \pm 10%

J = \pm 5%

N.B.: the standard tolerance for tantalum capacitors is 20%; if no tolerance is specified, it would be considered as 20%.

A 20% tolerance means in fact -20% to +20%.

THE RATED VOLTAGE

It is expressed directly in volts (V)

N.B.: 6,3V rated voltage can be coded as 6V.

CECC SPECIFICATIONS

Some of the products which are described in this catalogue are made to a CECC specification; these documents give in detail the following information for each type:

- The climatic, electrical and mechanical characteristics
- The test and inspection procedures
- The sampling methods and levels
- The tests periods

The reference specifications concerning the tantalum capacitors are the following:

CECC 30 000 (NFC 83-100)

Generic specification: fixed capacitors

- Terminology
- Quality Assessment Procedures
- Test and inspection methods

CECC 30 200 (NFC 83-112)

Sectional specification: tantalum capacitors

- Preferred characteristics
- Quality Assessment Procedures
- Test and inspection methods

CECC 30 201 XXX

Detail specifications solid tantalum capacitors

- Detailed characteristics for each type

CECC 30 202 XXX

Detail specifications wet tantalum capacitors

- Detailed characteristics for each type

CECC 30 800 (NFC 83-113)

Sectional specification: tantalum chip capacitors

- Preferred characteristics
- Quality Assessment Procedures
- Test and inspection methods

CECC 30 801 XXX

Detail specifications tantalum chip capacitors

- Detailed characteristics for each type
- The list of all the detail specifications is given in the selection guide, with the corresponding type.

NB: Some of the products refer to specifications which are no longer published.

OTHER SPECIFICATIONS

In addition to CECC approvals, some of the products are qualified to MIL standard M39006/22, M39006/25, DSCC DWG No. 93026 and some others are listed in ESA (European Space Agency) Preferred Parts Lists ESCC EPPL I or II.

Technical Selection Guide

















Type	Family			Case type				Leads type			Climatic category				Voltage range		Capa. range		Main features			
	Wet Electr.	Solid Polymer	Solid MnO ₂	Metal	Molded	Silver	Tantal.	Axial	Radial	SMD	-55°C +85°C	-55°C +105°C	-55°C +125°C	-55°C +200°C	U _R min. (V)	U _R max. (V)	C _R min. (µF)	C _R max. (µF)	Re-verse Voltage	High Surge current	Low ESR	High ripple current
CT79	•						•	•						•	6	125	1,7	1200	yes	no	no	yes
CT79 SMD	•						•		•					•	6	125	1,7	1200	yes	no	no	yes
CT79E	•						•	•						•	6	150	2,5	2200	yes	no	no	yes
CT79E SMD	•						•		•					•	6	150	2,5	2200	yes	no	no	yes
CT79 HT200	•						•	•					•	•	6	125	1,7	1200	yes	no	no	yes
CT79E HT200	•						•	•					•	•	6	150	2,5	2200	yes	no	no	yes
ST79	•						•	•						•	25	125	10	1800	yes	no	no	yes
ST79 SMD	•						•		•					•	25	125	10	1800	yes	no	no	yes
ST79 HT200	•						•	•					•	•	25	125	10	1800	yes	no	no	yes
WT83	•						•	•						•	10	125	150	10 000	no	no	no	yes
WS83	•						•		•					•	10	125	150	10 000	no	no	no	yes
DSCC 93026	•						•	•						•	25	125	10	1800	yes	no	no	yes
MIL 39006/22	•						•	•						•	6	125	1,7	1200	yes	no	no	yes
MIL 39006/25	•						•	•						•	25	125	6,8	680	yes	no	no	yes
CT9	•						•	•						•	6,3	150	3,0	1200	no	no	no	yes
CT9E	•						•	•						•	6,3	150	4,7	2200	no	no	no	yes
CT4	•						•	•						•	10	125	4,7	1000	no	no	no	yes
CT4E	•						•	•						•	6,3	150	1,7	2200	no	no	no	yes
AP31	•				•		•	•						•	10	150	168	30 000	no	no	no	yes
AP41	•				•		•	•						•	10	150	330	40 000	no	no	no	yes
AS31	•				•		•	•						•	150	450	27	733	no	no	no	yes
SPE0844	•				•		•	•						•	6	125	220	6000	yes	no	no	yes
SPE0844S	•				•		•	•						•	150	375	27	150	yes	no	no	yes
CTP21		•			•				•					•	16	100	22	560	no	yes	yes	yes
CTP42		•			•				•					•	16	100	47	1200	no	yes	yes	yes
CTS1			•	•				•						•	6,3	125	0,1	330	no	no	no	no
CTS1M			•	•				•						•	6,3	100	0,1	330	no	no	no	no
CTS13			•	•				•				•		•	6,3	63	0,1	330	no	no	no	no
CTS32			•	•				•						•	6,3	63	1	330	yes	yes	no	no
CTS23			•	•				•						•	6,3	63	1	1200	no	yes	no	no
CTS33			•	•				•						•	6,3	63	1,2	1000	no	yes	no	no
CTS21			•	•				•						•	6,3	50	5,6	330	yes	yes	yes	yes
CTS21E			•	•				•						•	6,3	63	22	1000	yes	yes	yes	yes
CTS41			•	•					•					•	6,3	50	0,1	150	yes	yes	no	no
CTS41 RSE			•	•					•					•	6,3	50	4,7	150	yes	yes	yes	yes
CTS4			•	•					•				•	•	6,3	50	0,1	150	no	no	no	no
CTS27			•	•					•					•	6,3	50	0,1	330	no	no	no	no
CTC3			•	•					•					•	4	50	0,1	150	no	no	no	no
CTC4			•	•					•					•	4	50	0,1	100	no	yes	no	yes
CTC3E			•	•					•					•	4	50	0,15	680	no	no	no	no
CTC4 ESR			•	•					•					•	4	50	4,7	1000	no	yes	yes	yes
CTC21			•	•					•					•	6,3	63	5,6	330	no	yes	yes	yes
CTC21E			•	•					•					•	6,3	100	10	680	no	yes	yes	yes
CTC23			•	•					•					•	6,3	63	15	1000	no	no	no	no
CTC42			•	•					•					•	6,3	63	12	680	no	yes	yes	yes
CTC42E			•	•					•					•	6,3	80	22	1500	no	yes	yes	yes
SMT47			•	•					•					•	6,3	63	47	1500	no	yes	yes	yes

Classification according to specification

Specification	Harmonized specification	Qualified or equivalent product	Type	Case type
CECC 30201-001	CECC 30201-801	CTS1	Solid MnO ₂	Metal
CECC 30201-002	CECC 30201-801	CTS1	Solid MnO ₂	Metal
CECC 30201-003		CTS4	Solid MnO ₂	Molded
CECC 30201-005		CTS13	Solid MnO ₂	Metal
CECC 30201-007		CTS27	Solid MnO ₂	Molded
CECC 30201-019		CTS32	Solid MnO ₂	Metal
CECC 30201-025		CTS23	Solid MnO ₂	Metal
CECC 30201-026		CTS33	Solid MnO ₂	Metal
CECC 30201-037		CTS41	Solid MnO ₂	Molded
CECC 30201-040		CTS21 - CTS21E	Solid MnO ₂	Metal
CECC 30202-001	CECC 30202-801	CT79 - CT79E	Wet	Tantalum
CECC 30202-001	CECC 30202-801	CT79 HT200 - CT79E HT200	Wet	Tantalum
CECC 30202-003		CT4	Wet	Silver
CECC 30202-004		CT9	Wet	Silver
CECC 30202-005	CECC 30202-801	CT79 - CT79E	Wet	Tantalum
CECC 30202-005	CECC 30202-801	CT79 HT200 - CT79E HT200	Wet	Tantalum
CECC 30801-013		CTC21 - CTC21E	Solid MnO ₂	Molded SMD
MIL-PRF-39003/01		CTS1M	Solid MnO ₂	Metal
MIL-PRF-39006/22		39006/22	Wet	Tantalum
MIL-PRF-39006/25		39006/25	Wet	Tantalum
DSCC 93026		93026	Wet	Tantalum
DSCC 10004		WT83	Wet	Tantalum
DSCC 10004		WS83	Wet	Tantalum
IEC 60384-3		SMT47	Solid MnO ₂	Molded SMD
ESCC 3012/002		CTC21	Solid MnO ₂	Molded SMD
ESCC 3012/003		CTC21E	Solid MnO ₂	Molded SMD
ESCC 3003/005		CT79 - CT79E	Wet	Tantalum
ESCC 3003/006		ST79	Wet	Tantalum





Selection Guide

WET TANTALUM CAPACITORS - HERMETICALLY SEALED - TANTALUM CASES





Model	Detail specification	Capacitance range	Voltage range	Temperature range	Main Features	Page
CT79 	 CECC 30202-005 CECC 30202-001 CECC 30202-801 CT79 only: ESCC 3003/005 ESA/ESCC EPPL2	1,7 μ F 1200 μ F	125 V 6 V	-55°C +125°C	Reverse voltage High ripple current	20
CT79 SMD 						21
CT79E 	 CECC 30202-005 CECC 30202-001 CECC 30202-801 CT79E only: ESCC 3003/005 ESA/ESCC EPPL2	2,5 μ F 2200 μ F	150 V 6 V	-55°C +125°C	Reverse voltage High ripple current Extended range	20
CT79E SMD 						21
CT79 HT200 	CECC 30202-005 CECC 30202-001 CECC 30202-801	1,7 μ F 1200 μ F	125 V 6 V	-55°C +200°C	High Temperature	27
CT79E HT200 	CECC 30202-005 CECC 30202-001 CECC 30202-801	2,5 μ F 2200 μ F	150 V 6 V	-55°C +200°C	High Temperature Extended range	27
ST79 	 According to DSCC DWG No. 93026 ST79 only: ESCC 3003/006 ESA/ESCC EPPL2	10 μ F 1800 μ F	125 V 25 V	-55°C +125°C	High capacitance Very high ripple current	34
ST79 SMD 						36
ST79 HT200 	According to DSCC DWG No. 93026	10 μ F 1800 μ F	125 V 25 V	-55°C +200°C	High temperature High capacitance	38
WT83 	According to DSCC DWG No. 10004	150 μ F 10 000 μ F	125 V 10 V	-55°C +125°C	Very high capacitance Enhanced performances	40
WS83 						42
DSCC 93026 	DSCC DWG No. 93026	10 μ F 1800 μ F	125 V 25 V	-55°C +125°C	High capacitance Very high ripple current MIL Qualified	44
MIL 39006/22 	MIL-PRF-39006/22 Failure rate level M	1,7 μ F 1200 μ F	125 V 6 V	-55°C +125°C	Reverse voltage High ripple current MIL Qualified	46
MIL 39006/25 	MIL-PRF-39006/25 Failure rate level M	6,8 μ F 680 μ F	125 V 25 V	-55°C +125°C	Reverse voltage High ripple current Extended range MIL Qualified	49

Selection Guide



WET TANTALUM CAPACITORS - HERMETICALLY SEALED - SILVER CASES

Model	Detail specification	Capacitance range	Voltage range	Temperature range	Main Features	Page
CT9 	According to CECC 30202-004	3 μ F	150 V	-55°C +125°C	Glass-metal hermetical seal	51
CT9CR		1200 μ F	6,3 V			52
CT9E 	According to CECC 30202-004	4,7 μ F	150 V	-55°C +125°C	Extended range	51
CT9 RSE		2200 μ F	6,3 V			52
CT4 	CECC 30202-003	4,7 μ F 1000 μ F	125 V 10 V	-55°C +125°C	Resin sealing	57
CT4E 	BS 9073 F008 BS 9073 F032	1,7 μ F 2200 μ F	150 V 6,3 V	-55°C +125°C	Extended range	57

WET TANTALUM CAPACITORS - MOLDED CASES







Model	Detail specification	Capacitance range	Voltage range	Temperature range	Main Features	Page
AP31  NEW		168 μ F 30000 μ F	150 V 10 V	-55°C +125°C	Parallel assembly of capacitors High capacitance	64
AP41  NEW		330 μ F 40000 μ F	150 V 10 V	-55°C +125°C	Parallel assembly of capacitors Very high capacitance	66
AS31  NEW		27 μ F 733 μ F	450 V 150 V	-55°C +125°C	Serial assembly of capacitors Very high voltage	68
SPE0844 	BS CECC 30202-009 CECC 30202-005 CECC 30202-001 CECC 30202-801	220 μ F 6000 μ F	125 V 6 V	-55°C +125°C	Parallel assembly of capacitors Reverse voltage High ripple current	70
SPE0844S 	CECC 30202-005 CECC 30202-001 CECC 30202-801	27 μ F 150 μ F	375 V 150 V	-55°C +125°C	Serial assembly of capacitors Very high voltage	73

SOLID TANTALUM POLYMER CAPACITORS - MOLDED CASES - SMD

Model	Detail specification	Capacitance range	Voltage range	Temperature range	Main Features	Page
CTP21 		33 μ F 560 μ F	75 V 16 V	-55°C +105°C	Very low ESR High ripple current High surge current No thermal ignition	80
CTP42  NEW		68 μ F 1200 μ F	75 V 16 V	-55°C +105°C	Parallel assembly of two CTP21 Ultra low ESR	82



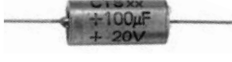

Selection Guide

SOLID TANTALUM MnO₂ CAPACITORS - HERMETICALLY SEALED - METAL CASES

Model	Detail specification	Capacitance range	Voltage range	Temperature range	Main Features	Page
CTS1 	CECC 30201-001 CECC 30201-002 CECC 30201-801 CEI 300201-FR0001	0,1 μ F 330 μ F	125 V 6,3 V	-55°C + 125°C	Standard range General purpose +125°C	97
CTS1M 	According to MIL-PRF 39003/01	0,1 μ F 330 μ F	100 V 6,3 V	-55°C + 125°C	Standard range Equivalent to CSR13	97
CTS13 	CECC 30201-005	0,1 μ F 330 μ F	63 V 6,3 V	-55°C + 85°C	Standard range General purpose +85°C	97
CTS32 	CECC 30201-019	1 μ F 330 μ F	63 V 6,3 V	-55°C + 125°C	Standard range High surge current Reverse voltage	97
CTS23 	According to CECC 30201-025	1 μ F 1200 μ F	63 V 6,3 V	-55°C + 125°C	Extended range General purpose	102
CTS33 	According to CECC 30201-026	1,2 μ F 1000 μ F	63 V 6,3 V	-55°C + 125°C	Extended range Low leakage current	102
CTS21 	CECC 30201-040	5,6 μ F 330 μ F	50 V 6,3 V	-55°C + 125°C	Very low ESR High ripple current High surge current	105
CTS21E 	CECC 30201-040	22 μ F 1000 μ F	63 V 6,3 V	-55°C + 125°C	Very low ESR High ripple current High surge current	105

Selection Guide

SOLID TANTALUM MnO₂ CAPACITORS - MOLDED CASES

Model	Detail specification	Capacitance range	Voltage range	Temperature range	Main Features	Page
CTS41 	CECC 30201-037	0,1µF 150µF	50 V 6,3 V	-55°C + 125°C	Miniature +125°C High surge current Reverse voltage	110
CTS41 RSE 		4,7µF 150µF	50 V 6,3 V	-55°C + 125°C	Like CTS41 Low ESR	110
CTS4 	CECC 30201-003	0,1µF 150µF	50 V 6,3 V	-55°C + 85°C	Miniature General purpose +85°C	110
CTS27 	According to CECC 30201-007	0,1µF 330µF	50 V 6,3 V	-55°C + 125°C	Transfer moulding Max. height 10,5 mm	113

Selection Guide

SOLID TANTALUM MnO₂ CAPACITORS - MOLDED CASES - SMD

Model	Detail specification	Capacitance range	Voltage range	Temperature range	Main Features	Page	
CTC3 		0,1 μ F 150 μ F	50 V 4 V	-55°C + 125°C	Standard chip size General purpose	118	
CTC3E 		0,15 μ F 680 μ F	50 V 4 V	-55°C + 125°C	Extended range	118	
CTC4 		0,1 μ F 100 μ F	50 V 6,3 V	-55°C + 125°C	High surge current	118	
CTC3E Low profile 		1 μ F 330 μ F	50 V 4 V	-55°C + 125°C	Extended range Low profile	123	
CTC4 RSE 		4,7 μ F 1000 μ F	50 V 6,3 V	-55°C + 125°C	Low ESR High ripple current High surge current	125	
CTC21 	 EPPL1	CECC 30801-013 ESCC 3012/002 ESA/ESCC EPPL1	5,6 μ F 330 μ F	63 V 6,3 V	-55°C + 125°C	Very low ESR High ripple current High surge current	128
CTC21 E 	 EPPL2	CECC 30801-013 ESCC 3012/003 ESA/ESCC EPPL2	10 μ F 680 μ F	100 V 6,3 V	-55°C + 125°C	Extended range	128
CTC23 		15 μ F 1000 μ F	63 V 6,3 V	-55°C + 125°C	General purpose Extended range	131	
CTC42 		12 μ F 680 μ F	63 V 6,3 V	-55°C + 125°C	Parallel assembly of two CTC21	133	
CTC42E 		22 μ F 1500 μ F	80 V 6,3 V	-55°C + 125°C	Extended range	133	
SMT47 	NEW	IEC 60384-3	47 μ F 2500 μ F	63 V 4 V	-55°C + 125°C	Extended Capacitance Low ESR Enhanced performances	136

WET TANTALUM CAPACITORS

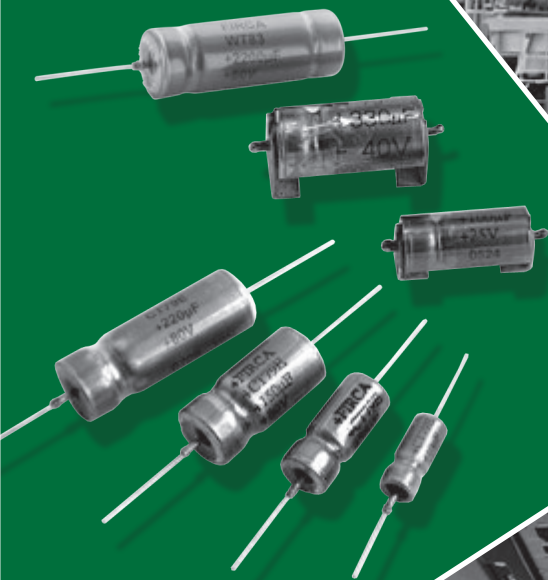

Electrical characteristics

CAPACITANCE

The capacitance is defined by a rated value (C_R , indicated on the capacitor) and a tolerance (generally $\pm 20\%$).

The capacitance is measured at a 100Hz or at a 120Hz frequency under a 0,1 to 1 V_{AC} voltage and a 2,1 to 2,5 V bias (or 9 to 10 V for $U_R \geq 100$ V).

At room temperature, it must be in the range defined by the rated value and the tolerance.

Capacitance change vs temperature: see typical curves below. Maximum changes are given, for each type, on the data sheets.

CAPACITANCE CHANGE VS TEMPERATURE

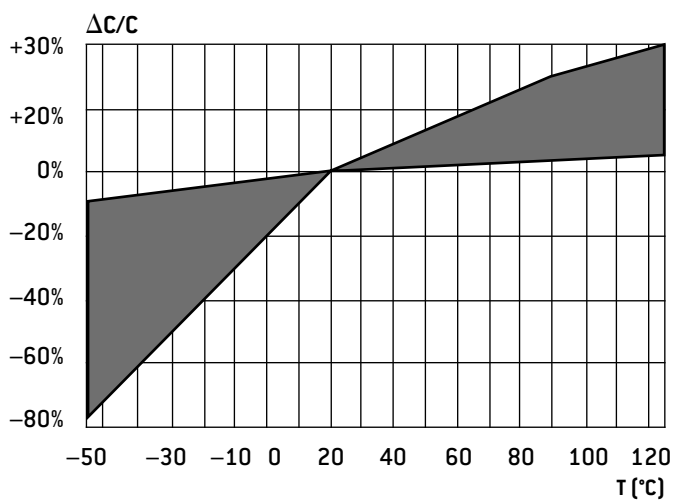

TOLERANCE (ON RATED CAPACITANCE)

It defines, with the rated capacitance, the range in which the capacitance value must be at room temperature.

e.g.: Rated capacitance: $100\mu F$

Tolerance: 20%

The measured capacitance must be between:

$$100 - (20\% \text{ of } 100) = 80\mu F \text{ and } 100 + (20\% \text{ of } 100) = 120\mu F$$

The standard tolerance for tantalum capacitors is 20%.

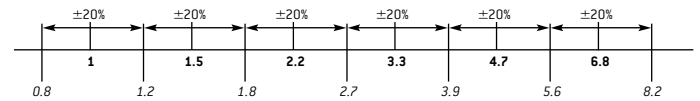

Electrical characteristics

DIRECT DC VOLTAGE

The **rated voltage (U_R)**, indicated on the capacitor, is the maximum DC voltage which can be applied continuously between -55°C and $+85^\circ\text{C}$.

For the types which can be used up to 125°C , the voltage must be derated between $+85^\circ\text{C}$ and $+125^\circ\text{C}$ according to the following curve.

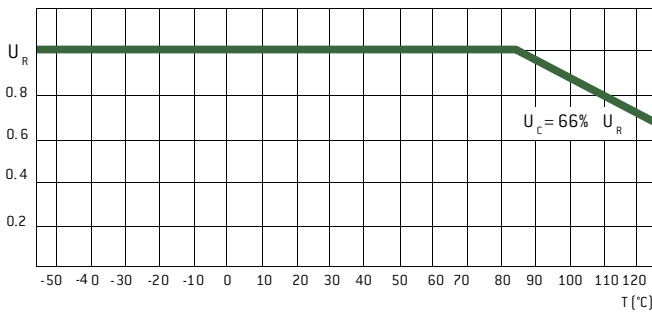

For the types which can be used up to 200°C , the voltage must be derated between $+85^\circ\text{C}$ and $+200^\circ\text{C}$ according to the following curve.

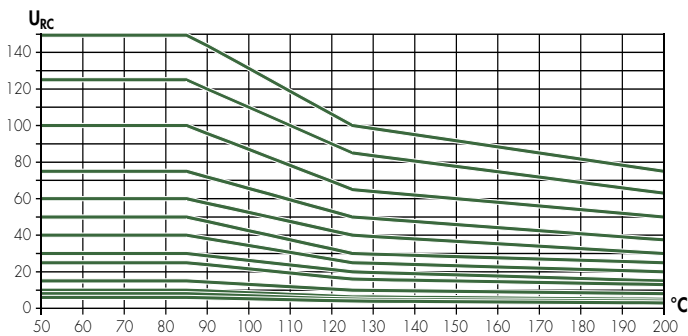

The **category voltage (U_C)** is consequently the maximum DC voltage which can be applied continuously at $+125^\circ\text{C}$.

The **surge voltage** is the maximum voltage which can be applied for short periods.

It is given for each type in the data sheet and is generally equal to 1,15 times U_R between -55°C and $+85^\circ\text{C}$ and 1,15 times U_C at $+125^\circ\text{C}$.

Tests are performed with charging periods of 30 seconds, through a $1000\ \Omega$ resistor, and discharging periods of 5 min 30s. 1000 cycles are done.

REVERSE VOLTAGE

Capacitors in silver cases (CT4, CT4E, CT9, CT9E) and some in tantalum cases (WT83, WS83) cannot withstand any reverse voltage: it would cause damage, more or less rapidly depending upon the voltage value.

It is therefore necessary to be sure that the bias voltage is high enough to avoid that the AC voltage creates a reverse voltage (negative peak).

Other capacitors in tantalum cases (CT79, CT79E, ST79, DSCC 93026, M39006/22 and M39006/25) can withstand a reverse voltage as specified in the individual datasheet.

LEAKAGE CURRENT

Leakage current is the residual current which flows through the capacitor after the charging time, under rated voltage. It is measured after a time not exceeding 5 minutes and is given in μA .

It is equivalent to the insulation resistance of the capacitor and it must be as low as possible.

Maximum leakage current is a function of capacitance and rated voltage values and is given, for each type, in the data sheets.

LEAKAGE CURRENT CHANGE VS APPLIED VOLTAGE

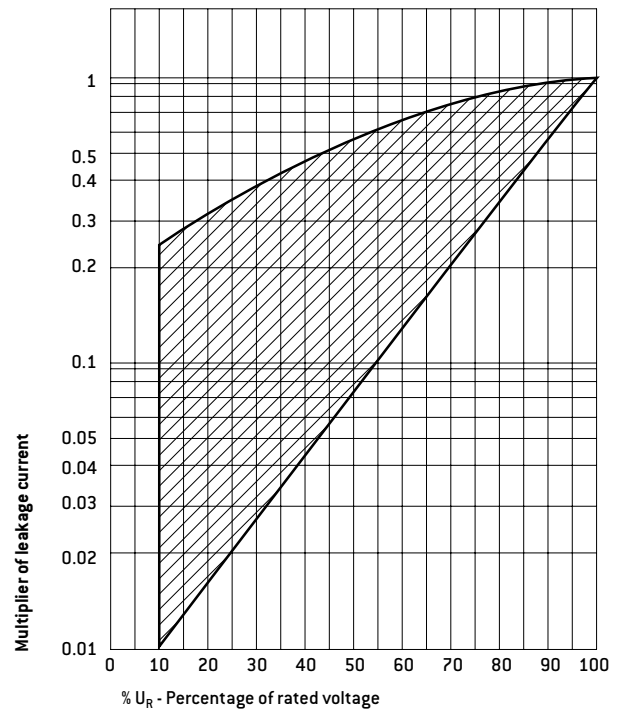

Electrical characteristics

DISSIPATION FACTOR

Dissipation factor is generally measured at the same time as the capacitance, with the same conditions. It is a function of the series resistance of the capacitor and the capacitance at low frequency.

$$DF = ESR \times C \times 2\pi f$$

At low frequency, the series resistance is the sum of an ohmic part (leads, contacts, MnO₂) and the dielectric losses.

Dissipation factor is given in % and maximum limits are given for each type in the data sheets.

EQUIVALENT SERIES RESISTANCE OR IMPEDANCE

Equivalent circuit of a capacitor

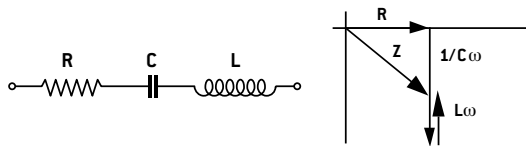

R: equivalent series resistance of the capacitor (leads, contacts, MnO₂, dielectric losses)

L: inductance mainly due to the leads

C: capacitance

Impedance

It is specified at 100Hz and -55°C and the formula for impedance is:

$$Z = \sqrt{R^2 + [L\omega - 1/C\omega]^2}$$

It can be seen that:

- at low frequencies, impedance is a function of capacitance
- at high frequencies, impedance is a function of inductance
- at medium frequencies, it is a function of the ESR

Maximum impedance: see data sheets.

ESR CHANGE VS TEMPERATURE

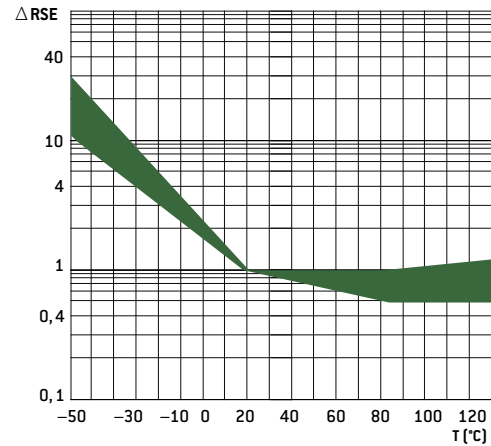

ESR CHANGE VS FREQUENCY

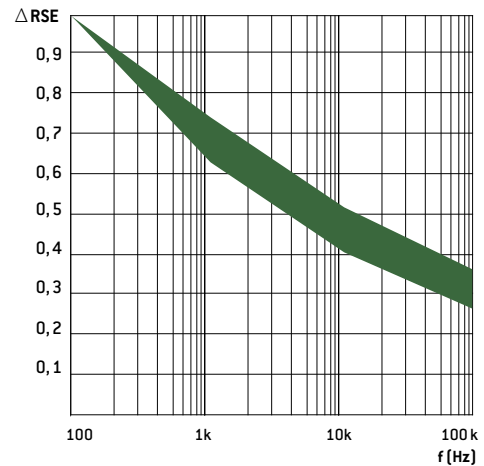

Electrical characteristics

MAXIMUM RIPPLE CURRENT

CT79/79E (SMD) - CT79/79E HT200 - ST79 (SMD) - ST79 HT200 - WT83 - WS83

Maximum ripple currents which are indicated in the data sheets are given for the following conditions:

Temperature: +85°C (+70°C only WT82)

Frequency: 40kHz

Applied voltage: 0,66

If conditions are different, use the multipliers given in the table below to calculate the new maximum current.

Frequency	100Hz				1kHz				10kHz				40kHz				100kHz				
	+55°C	+85°C	+105°C	+125°C	+55°C	+85°C	+105°C	+125°C	+55°C	+85°C	+105°C	+125°C	+55°C	+85°C	+105°C	+125°C	+55°C	+85°C	+105°C	+125°C	
Peak voltage in % of U_R	66%	0,6	0,6	0,46	0,27	0,72	0,72	0,55	0,32	0,88	0,88	0,68	0,4	1	1	0,77	0,45	1,1	1,1	0,85	0,5
	70%	0,6	0,58	0,44	–	0,72	0,7	0,52	–	0,88	0,85	0,64	–	1	0,97	0,73	–	1,1	1,07	0,8	–
	80%	0,6	0,52	0,35	–	0,72	0,62	0,42	–	0,88	0,76	0,52	–	1	0,87	0,59	–	1,1	0,96	0,65	–
	90%	0,6	0,46	–	–	0,72	0,55	–	–	0,88	0,67	–	–	1	0,77	–	–	1,1	0,85	–	–
	100%	0,6	0,39	–	–	0,72	0,45	–	–	0,88	0,55	–	–	1	0,63	–	–	1,1	0,69	–	–

CT4 - CT4E - CT9 - CT9E TYPES

Maximum ripple currents which are indicated in the data sheets are given for the following conditions:

- frequency from 100Hz to 100kHz and more
- temperature from –55°C to +85°C

Correction vs temperature

If the temperature is higher than 85°C, decrease linearly the maximum value from 100% at +85°C to 80% at +125°C.

Correction vs frequency

If frequency is lower than 100Hz, apply the following multipliers to the maximum ripple currents:

75Hz: 0,79 **60Hz:** 0,65 **50Hz:** 0,55 **25Hz:** 0,55

OTHERS RULES (FOR ALL TYPES)

- the sum of the positive peak AC voltage and the DC bias voltage must be lower than the rated voltage.
- the negative peak must not create any Reverse voltage (or maximum 3 volts for CT79 and CT79E types).
- because of the increase of the series resistance at low temperature, it is better to not apply directly the maximum ripple current but to increase this one gradually to raise the capacitor temperature.

CLIMATIC CHARACTERISTICS

1- CLIMATIC CATEGORY

Climatic category defines the temperature range over which the capacitor can be used continuously, and also the number of days for the damp heat test (this test is performed periodically at 40°C with a 93% moisture rate).

Note: it is necessary to derate the voltage for temperatures higher than 85°C (see page 15).

2- THERMAL SHOCKS - RAPID CHANGES OF TEMPERATURE

This test is performed to check that the capacitors can withstand sudden temperature changes. The method which is used is the one with two chambers, one at –55°C, the other one at +125°C. Five cycles are performed, with 30min at low temperature and 30min at high temperature, during the periodical tests (30 cycles for CT79 type). Electrical characteristics are measured after this test.

3 - DAMP HEAT TEST

This test is performed during the periodical test, with the following conditions:

Temperature: 40°C

Humidity: 90 to 95%

DC voltage: without

Time: 21 or 56 days

Electrical characteristics are measured after this test.

MECHANICAL CHARACTERISTICS

1 - VIBRATIONS

This test is performed during the periodical test, with the following conditions:

CT9 - CT9E types

- Frequency: 10 to 2000Hz
- Amplitude: 1,5mm or 196m/s² - 20g
- Time: 6 hours

CT79/79E (SMD) - CT79/79E HT200 - ST79 (SMD) - ST79 HT200 - WT83 - WS83

- Frequency: 10 to 2000Hz
- Amplitude: 3,5mm or 490m/s² - 50g
- Time: 6 hours

2 - SHOCKS

This test is performed just after the vibrations test, with the following conditions for all types:

- Acceleration: 981 m/s² - 100g
- Pulse width: 6 ms
- Shape: 1/2 sinewave
- Number of shocks: 18 (3 in each direction, positive and negative)

Electrical characteristics

RELIABILITY

Reliability of a component can be defined as its probability to work without any failure, in defined conditions and during a fixed time.

Reliability is not therefore only a function of the component quality, but also of the application and environmental conditions.

The parameter which is the most commonly used for the reliability is the failure rate in time, generally expressed in % per 1000 hours.

CALCULATION OF A COMPONENT FAILURE RATE USED IN AN EQUIPMENT

The calculation method on the next page uses parameters which are given by the CNET (Centre National d'Étude des Télécommunications) in its Reliability Data Book (RDF 1993).

The failure rate is calculated with parameters which are function of the capacitor (capacitance, case type, approvals, high surge current test) and others ones which are representative of application conditions (voltage, temperature, resistance in serie, environmental conditions).

Example:

CT79E 2200 μ F - 6,3 V used under 3 volts, at 40°C, in a satellite in orbit:

$$\pi_t = 1,2 \quad \pi_v = 1,38$$

$$\pi_c = 1,4 \quad \pi_E = 0,5 \quad \pi_q = 1$$

$$\lambda = 3 \times 1,2 \times 1,38 \times 1,4 \times 0,5 \times 1.10^{-9}/h = 3,5.10^{-9}/h = 0,00035 \% \text{ defects}/1000 \text{ hours}$$

π_t = TEMPERATURE INFLUENCE

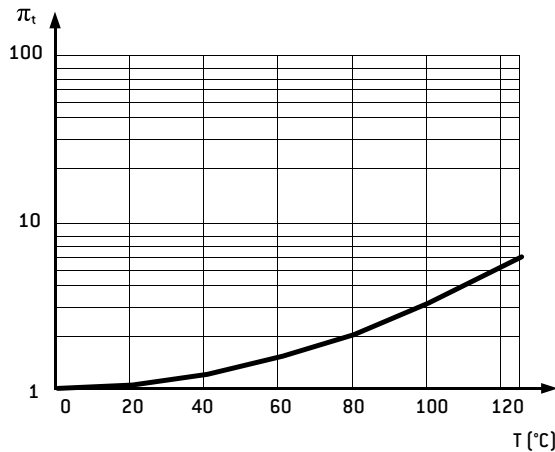

$$\text{Formula: } \pi_t = \exp [1,8. (t / tm)^2]$$

with: t = using temperature
tm = maximum temperature
Curve for tm = 125°C

π_v = INFLUENCE OF APPLIED VOLTAGE VS RATED VOLTAGE

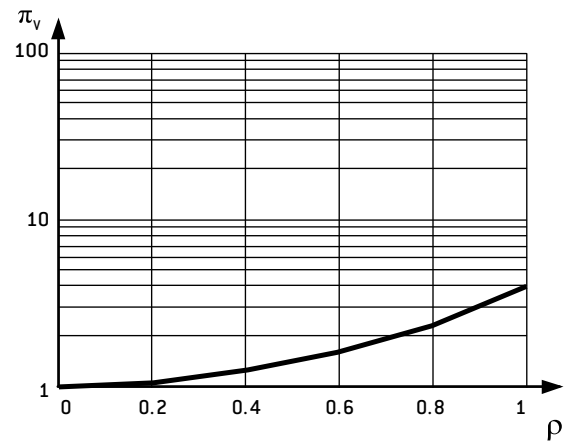

$$\text{Formula: } \pi_v = \exp [(\rho / 0,85)^2]$$

$$\rho = \frac{\text{peak voltage}}{\text{rated voltage}}$$

Curve $\pi_v = f(\rho)$

π_c = INFLUENCE OF CAPACITANCE

3,3 μ F	$\pi_c = 0,9$
20 μ F	$\pi_c = 1,0$
1000 μ F	$\pi_c = 1,3$
2200 μ F	$\pi_c = 1,4$

π_E = INFLUENCE OF APPLICATION

Satellite in orbit	$\pi_E = 0,5$
Ground; stationary; protected	$\pi_E = 1$
Ground; stationary; non protected	$\pi_E = 2,5$
Ground; mobile; soft conditions	$\pi_E = 6$
Aircraft; soft conditions	$\pi_E = 6$
Ship; soft conditions	$\pi_E = 6$
Ground; mobile; hard conditions	$\pi_E = 8$
Ship; hard conditions	$\pi_E = 10$
Aircraft; hard conditions	$\pi_E = 15$
Satellite; launching	$\pi_E = 20$

π_q = INFLUENCE OF QUALIFICATION

Products approved to CECC	$\pi_q = 1,0$
Others products	$\pi_q = 2,0$

Electrical characteristics

PRODUCT SAFETY INFORMATION SHEET

This should read in conjunction with the Product Data Sheet/Specification.

Failure to observe the ratings, and the information on this sheet may result in a safety hazard.

1. MATERIAL CONTENT

Wet tantalum capacitors contain hazardous materials:

- Liquid electrolyte - gelled diluted sulphuric acid
- Solid tantalum anode

The device consists of solder coated terminal wires and the materials listed below:

- Silver case or tantalum case
- Rubber "o" rings
- PTFE spacers
- Filled epoxy resin end cap on silver case products

2. PHYSICAL FORM

These Capacitors are physically small and are cylindrical with axial leads.

3. INTRINSIC PROPERTIES

3.1 Operating

Wet tantalum capacitors will operate satisfactorily providing that the sum of the applied d.c. and the peak a.c. ripple voltage does not exceed the rated d.c. voltage.

There must be no reversal of polarity.

The maximum ripple currents and voltages and d.c. polarising voltages are specified in the data sheets.

Some tantalum cased devices will stand up to 3 V_{DC} Reverse for short periods of time.

A Reverse application of the rated voltage will result in loss of capacitance, early short circuit failure and may result in fire or explosion.

It may also cause consequential failure of other associated components in circuit, e.g. diodes, transformers, etc.

3.2 Non-Operating

Wet Tantalum capacitors contain electrolyte which is a conducting material.

If electrolyte leaks onto a printed circuit board or similar insulated support, short circuits can be caused.

All electrolytes are corrosive to some extent.

No electrolyte should be allowed to come in contact with the skin, eyes, etc., and if they do appropriate medical treatment should be applied.

CONSTRUCTION

CT79/79E (SMD) - CT79/79E HT200 - ST79 (SMD) - ST79 HT200 - WT83 - WS83

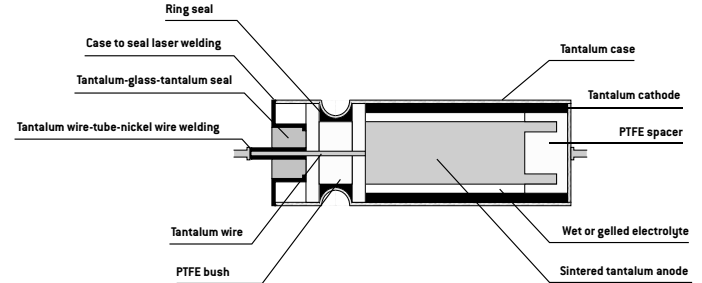

Glass metal seal: CT9 - CT9E

Epoxy sealing: CT4 - CT4E

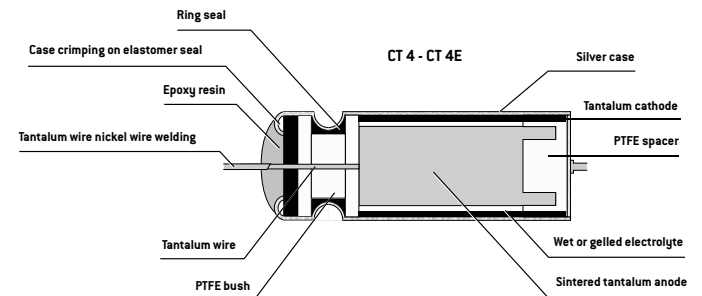
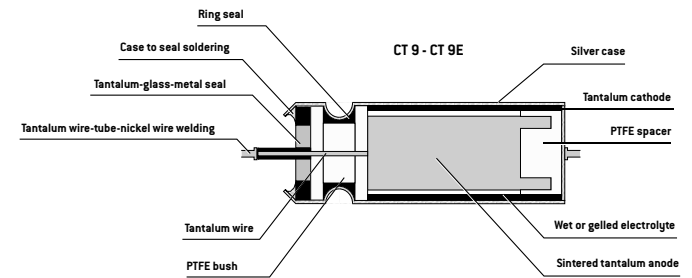

MARKING (except DSCC 93026, M39006/22, M39006/25)

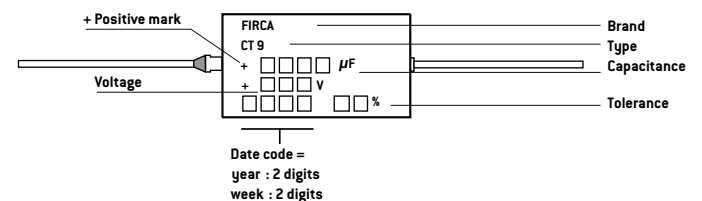

PACKAGING

In cardboard boxes

CT79 CT79E



Wet tantalum capacitors
Hermetically sealed tantalum cases
Axial leads
Polarized

ELECTRICAL AND CLIMATIC CHARACTERISTICS

	CT79	CT79E
Detail specification	CECC 30202-801 - CECC 30202-005 - CECC 30202-001	CECC 30202-801 - CECC 30202-005 - CECC 30202-001
	According to MIL-PRF-39006/22	According to MIL-PRF-39006/25
	ESCC 3003/005	ESCC 3003/005
	ESA/ESCC EPPL2	ESA/ESCC EPPL2
Operating temperature	-55°C +125°C	-55°C +125°C
Damp heat	56 days	56 days
Capacitance range	1,7µF ⇒ 1200µF	5,6µF ⇒ 2200µF
Tolerance	±10% - ±20%	±10% - ±20%
Voltage range	6V ⇒ 125V	6V ⇒ 150V
Max. capacitance change -55°C	see table	see table
Max. capacitance change +85°C	see table	see table
Max. capacitance change +125°C	see table	see table
Maximum DF at +20°C	see table	see table
Maximum DF at +85°C	= lim20°C	= lim20°C
Maximum DF at +125°C	= lim20°C	= lim20°C
Max. impedance (100Hz) at -55°C	see table	see table
Max. leakage current at +20°C	see table	see table
Max. leakage current at +85°C	see table	see table
Max. leakage current at +125°C	= lim+85°C	= lim+85°C
Max. ripple current 40kHz +85°C	see table	see table
Max. Reverse voltage at +20°C	3 volts	3 volts
Max. Reverse voltage at +85°C	3 volts	3 volts
Max. Reverse voltage at +125°C	3 volts	3 volts
Max. surge voltage at +85°C	1,15 x U _R	1,15 x U _R
Max. surge voltage at +125°C	1,15 x U _C	1,15 x U _C

DIMENSIONS (mm)

Case code	Dimensions with insulating sleeve		
	L max	D max	d +10% -0,05
A	18	5,6	0,6
B	23	7,4	0,6
C	26	10,1	0,6
D	34	10,1	0,6

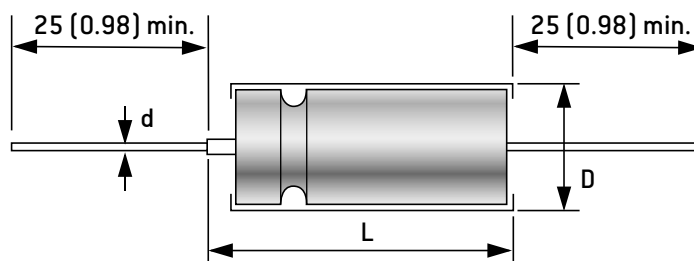

MARKING, PACKAGING, CONSTRUCTION:
see general characteristics

HOW TO ORDER

Commercial description	Model		Case	Capacitance in µF	Tolerance in %	DC Voltage	Termination
		CT79	CT79E	D	850µF	20%	25V
EXXELIA PN	Model code		Case	Capacitance code	Tolerance code	DC Voltage code	Termination
	TS79	TS79E	D	857	M	025	A
	Expressed in pF with 3 digits: 2 digits for the value and the third for the multiplier			K = 10% M = 20%	Expressed in volt with 3 digits	Commercial description H = SnPb (non RoHS) - = Sn100% (RoHS)	EXXELIA PN A = SnPb (non RoHS) F = Sn100% (RoHS)

CT79 SMD

CT79E SMD



Wet tantalum capacitors
Hermetically sealed tantalum cases
High ripple current
SMD
Polarized

ELECTRICAL AND CLIMATIC CHARACTERISTICS

	CT79 SMD	CT79E SMD
Detail specification	According to CECC 30202-801 - CECC 30202-005 - CECC 30202-001 According to MIL-PRF-39006/22 According to ESCC 3003/005	According to CECC 30202-801 - CECC 30202-005 - CECC 30202-001 According to MIL-PRF-39006/25 According to ESCC 3003/005
Operating temperature	-55°C +125°C	-55°C +125°C
Damp heat	56 days	56 days
Capacitance range	1,7µF ⇒ 1200µF	5,6µF ⇒ 2200µF
Tolerance	±10% - ±20%	±10% - ±20%
Voltage range	6V ⇒ 125V	6V ⇒ 150V
Max. capacitance change -55°C	see table	see table
Max. capacitance change +85°C	see table	see table
Max. capacitance change +125°C	see table	see table
Maximum DF at +20°C	see table	see table
Maximum DF at +85°C	= lim20°C	= lim20°C
Maximum DF at +125°C	= lim20°C	= lim20°C
Max. impedance (100Hz) at -55°C	see table	see table
Max. leakage current at +20°C	see table	see table
Max. leakage current at +85°C	see table	see table
Max. leakage current at +125°C	= lim+85°C	= lim+85°C
Max. ripple current 40kHz +85°C	see table	see table
Max. Reverse voltage at +20°C	3 volts	3 volts
Max. Reverse voltage at +85°C	3 volts	3 volts
Max. Reverse voltage at +125°C	3 volts	3 volts
Max. surge voltage at +85°C	1,15 x U _R	1,15 x U _R
Max. surge voltage at +125°C	1,15 x U _C	1,15 x U _C

DIMENSIONS (mm)

Case code	Dimensions with insulating sleeve					
	B max	F max	E ±0,4	C max	X max	Ø max
A	14	4,0	3,8	7,5	2,8	5,8
B	18,5	4,0	5,3	9,5	2,8	7,4
C	21,5	4,0	8,4	12,5	2,8	10,1
D	29,5	4,0	8,4	12,5	2,8	10,1

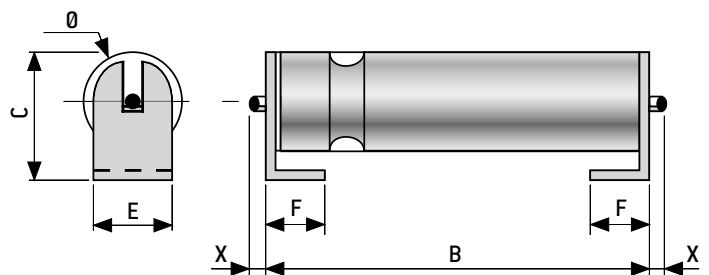

MARKING, PACKAGING, CONSTRUCTION:
see general characteristics

HOW TO ORDER

Commercial description	Model		Case	Capacitance in µF	Tolerance in %	DC Voltage	Termination
	CT79 SMD	CT79E SMD					
EXXELIA PN	Model code	Case	Capacitance code	Tolerance code	DC Voltage code	Termination	
	TS78	TS78E	D	857	M	025	A
	Expressed in pF with 3 digits: 2 digits for the value and the third for the multiplier			K = 10% M = 20%	Expressed in volt with 3 digits	Commercial description H = SnPb (non RoHS) + = Sn100% (RoHS)	EXXELIA PN A = SnPb (non RoHS) F = Sn100% (RoHS)

CT79

CT79 SMD

[Standard range]

STANDARD RATINGS - ELECTRICAL CHARACTERISTICS

Capacitance 100Hz +20°C (μ F)	Case (code)	Type	Capacitance maximum change			Max. DF +20°C (%)	Max. Impedance 100Hz -55°C (Ω)	Max. I leak		Irms Max. 40kHz +85°C (mA)	
			-55°C (%)	+85°C (%)	+125°C (%)			+20°C (μ A)	+85°C (μ A)		
Rated voltage (+85°C) 6 V - 6,3 V - Category voltage (+125°C) 4 V											
30	A	CT79	CT79 SMD	-40	+10	+12	9	100	1	2	820
68	A	CT79	CT79 SMD	-40	+14	+16	15	60	1	2	960
140	B	CT79	CT79 SMD	-40	+14	+16	21	40	1	3	1200
220	B	CT79	CT79 SMD	-44	+16	+18	36	30	1	6,5	1370
270	B	CT79	CT79 SMD	-44	+17	+20	41	25	1	6,5	1375
330	C	CT79	CT79 SMD	-44	+14	+16	36	20	2	7,9	1800
560	C	CT79	CT79 SMD	-64	+17,5	+20	50	25	2	13	1900
1000	D	CT79	CT79 SMD	-80	+25	+25	68	22	3	14	2388
1200	D	CT79	CT79 SMD	-80	+25	+25	86	20	3	14	2388
Rated voltage (+85°C) 8 V - Category voltage (+125°C) 5 V											
25	A	CT79	CT79 SMD	-40	+10,5	+12	7,5	100	1	2	820
56	A	CT79	CT79 SMD	-40	+14	+16	14	59	1	2	900
120	B	CT79	CT79 SMD	-44	+17,5	+20	20	50	1	2	1230
220	B	CT79	CT79 SMD	-44	+16	+18	37	30	1	7	1370
290	C	CT79	CT79 SMD	-64	+17,5	+20	34	25	2	6	1770
430	C	CT79	CT79 SMD	-64	+17,5	+20	46	25	2	14	1825
850	D	CT79	CT79 SMD	-80	+25	+25	60	22	3	16	2456
Rated voltage (+85°C) 10 V - Category voltage (+125°C) 6,3 V											
20	A	CT79	CT79 SMD	-32	+10,5	+12	6	175	1	2	820
47	A	CT79	CT79 SMD	-36	+14	+16	13	100	1	2	855
100	B	CT79	CT79 SMD	-36	+14	+16	15	60	1	4	1200
150	B	CT79	CT79 SMD	-32	+14	+16	28	45	1	7	1271
180	B	CT79	CT79 SMD	-35	+14	+16	29	40	1	7	1365
250	C	CT79	CT79 SMD	-40	+14	+16	30	30	2	10	1720
390	C	CT79	CT79 SMD	-64	+17,5	+20	44	25	2	15	1800
680	D	CT79	CT79 SMD	-80	+25	+25	42	20	3	16	2487
750	D	CT79	CT79 SMD	-80	+25	+25	50	23	3	16	2487
820	D	CT79	CT79 SMD	-80	+25	+25	53	22	3	16	2360
Rated voltage (+85°C) 15 V - 16 V - Category voltage (+125°C) 10 V											
15	A	CT79	CT79 SMD	-24	+10,5	+12	5	155	1	2	780
33	A	CT79	CT79 SMD	-28	+14	+16	10	90	1	2	820
70	B	CT79	CT79 SMD	-28	+14	+16	13	75	1	4	1150
120	B	CT79	CT79 SMD	-28	+14	+16	18	50	1	7	1450
170	C	CT79	CT79 SMD	-32	+14	+16	25	35	2	10	1480
220	C	CT79	CT79 SMD	-41	+13	+15	21	40	2	6	1490
270	C	CT79	CT79 SMD	-56	+17,5	+20	32	30	2	14	1740
330	C	CT79	CT79 SMD	-58	+18	+20	40	30	2	14	1760
470	D	CT79	CT79 SMD	-75	+25	+25	33	24	3	18	2100
540	D	CT79	CT79 SMD	-80	+25	+25	40	23	3	18	2300
560	D	CT79	CT79 SMD	-80	+25	+25	36	23	3	18	2300
Rated voltage (+85°C) 25 V - Category voltage (+125°C) 16 V											
10	A	CT79	CT79 SMD	-16	+8	+9	4	220	1	2	715
22	A	CT79	CT79 SMD	-20	+10	+12	6,6	140	1	2	825
50	B	CT79	CT79 SMD	-28	+13	+15	11	70	1	2	1130
100	B	CT79	CT79 SMD	-28	+13	+15	15	50	1	9	1435
120	C	CT79	CT79 SMD	-32	+13	+15	21	38	2	6	1450
180	C	CT79	CT79 SMD	-48	+13	+15	26	32	2	13	1700
330	D	CT79	CT79 SMD	-60	+25	+25	28	27	3	20	2000
350	D	CT79	CT79 SMD	-64	+25	+25	35	24	3	20	2246
390	D	CT79	CT79 SMD	-68	+25	+25	32	24	3	20	2025
560	D	CT79	CT79 SMD	-65	+25	+30	46	15	9	36	2040
Rated voltage (+85°C) 30 V - Category voltage (+125°C) 20 V											
8	A	CT79	CT79 SMD	-16	+8	+12	4	275	1	2	640
15	A	CT79	CT79 SMD	-20	+10	+12	5	175	1	2	780
40	B	CT79	CT79 SMD	-24	+10,5	+12	10	65	1	5	1120
68	B	CT79	CT79 SMD	-24	+13	+15	13	60	1	8	1285
100	C	CT79	CT79 SMD	-28	+10,5	+12	17	40	2	12	1477
150	C	CT79	CT79 SMD	-48	+13	+15	23	35	2	12	1525
300	D	CT79	CT79 SMD	-60	+25	+25	30	25	3	20	2100

(Standard range)

CT79
CT79 SMD

STANDARD RATINGS - ELECTRICAL CHARACTERISTICS

Capacitance 100Hz +20°C (μ F)	Case (code)	Type	Capacitance maximum change			Max. DF +20°C (%)	Max. Impedance 100Hz -55°C (Ω)	Max. I leak		Irms Max. 40kHz +85°C (mA)	
			-55°C (%)	+85°C (%)	+125°C (%)			+20°C (μ A)	+85°C (μ A)		
Rated voltage (+85°C) 40 V - Category voltage (+125°C) 25 V											
12	A	CT79	CT79 SMD	-24	+8	+10	6	234	1	2	450
56	B	CT79	CT79 SMD	-28	+13	+15	14	78	1	9	1100
100	C	CT79	CT79 SMD	-40	+13	+15	18	48	2	17	1450
220	D	CT79	CT79 SMD	-55	+23	+23	22	27	3	22	1900
Rated voltage (+85°C) 50 V - Category voltage (+125°C) 30 V											
5	A	CT79	CT79 SMD	-16	+5	+6	3	400	1	2	580
10	A	CT79	CT79 SMD	-20	+8	+9	4	250	1	2	715
25	B	CT79	CT79 SMD	-20	+10,5	+12	8	95	1	5	1065
47	B	CT79	CT79 SMD	-24	+13	+15	11	70	1	9	1215
60	C	CT79	CT79 SMD	-16	+10,5	+12	12	45	2	12	1335
82	C	CT79	CT79 SMD	-32	+13	+15	15	45	2	10	1460
160	D	CT79	CT79 SMD	-50	+23	+23	17	27	3	22	2040
Rated voltage (+85°C) 60 V - 63 V - Category voltage (+125°C) 40 V											
4	A	CT79	CT79 SMD	-16	+5	+6	2,8	550	1	2	525
8,2	A	CT79	CT79 SMD	-20	+8	+9	4	275	1	2	625
20	B	CT79	CT79 SMD	-16	+10,5	+12	+7	105	1	5	1026
39	B	CT79	CT79 SMD	-24	+10	+12	10	90	1	9	1185
50	C	CT79	CT79 SMD	-16	+10,5	+12	10	50	2	12	1341
68	C	CT79	CT79 SMD	-30	+10,5	+12	13	50	2	10	1393
140	D	CT79	CT79 SMD	-40	+20	+20	16	28	3	22	1990
150	D	CT79	CT79 SMD	-40	+20	+20	17	27	3	22	1865
Rated voltage (+85°C) 75 V - 80 V - Category voltage (+125°C) 50 V											
3,5	A	CT79	CT79 SMD	-16	+5	+6	2,5	650	1	2	525
6,8	A	CT79	CT79 SMD	-20	+8	+9	3	300	1	2	610
15	B	CT79	CT79 SMD	-16	+8	+9	6	150	1	5	1000
33	B	CT79	CT79 SMD	-24	+10	+12	10	90	1	9	1079
40	C	CT79	CT79 SMD	-16	+10,5	+12	9	60	2	12	1293
56	C	CT79	CT79 SMD	-28	+10,5	+15	11	60	2	10	1396
68	C	CT79	CT79 SMD	-30	+14	+15	13	50	2	10	1522
100	D	CT79	CT79 SMD	-35	+20	+20	12	36	9	36	1500
110	D	CT79	CT79 SMD	-35	+20	+20	11	29	3	24	1990
120	D	CT79	CT79 SMD	-36	+20	+20	12	28	3	24	1914
150	D	CT79	CT79 SMD	-48	+21	+22	17	30	9	36	1914
Rated voltage (+85°C) 100 V - Category voltage (+125°C) 65 V											
2,5*	A	CT79	CT79 SMD	-16	+7	+8	2	950	1	2	505
4,7	A	CT79	CT79 SMD	-16	+7	+8	3	500	1	2	565
11*	B	CT79	CT79 SMD	-16	+8	+8	5	200	1	4	835
22	B	CT79	CT79 SMD	-16	+7	+8	7,5	100	1	9	1065
30	C	CT79	CT79 SMD	-16	+8	+8	7	80	2	12	1240
33	C	CT79	CT79 SMD	-16	+8	+8	7	93	2	10	1200
39	C	CT79	CT79 SMD	-16	+8	+8	8	90	2	10	1282
43	C	CT79	CT79 SMD	-20	+8	+8	8	70	2	10	1389
47	C	CT79	CT79 SMD	-20	+7	+8	8	70	2	10	1389
68	D	CT79	CT79 SMD	-24	+15	+15	8	42	3	26	1859
82	D	CT79	CT79 SMD	-24	+15	+15	10	39	3	24	1859
86	D	CT79	CT79 SMD	-24	+15	+15	10	30	3	24	1859
Rated voltage (+85°C) 125 V - Category voltage (+125°C) 85 V											
1,7*	A	CT79	CT79 SMD	-16	+7	+8	2	1250	1	2	415
2,2	A	CT79	CT79 SMD	-16	+7	+8	2	1250	1	2	452
2,7	A	CT79	CT79 SMD	-16	+7	+8	3	780	1	2	452
3,3	A	CT79	CT79 SMD	-16	+7	+8	3	600	1	2	495
3,6	A	CT79	CT79 SMD	-16	+7	+8	2,7	600	1	2	520
3,9	A	CT79	CT79 SMD	-16	+7	+8	3,5	557	1	2	495
9*	B	CT79	CT79 SMD	-16	+7	+8	5	240	1	5	755
14	B	CT79	CT79 SMD	-16	+7	+8	6	167	1	7	1050
15	B	CT79	CT79 SMD	-16	+7	+8	6	167	1	7	1050
18*	C	CT79	CT79 SMD	-16	+7	+8	5	129	2	9	1130
25	C	CT79	CT79 SMD	-16	+7	+8	6	93	2	10	1335
27	C	CT79	CT79 SMD	-16	+7	+8	6	106	2	13	1282
56	D	CT79	CT79 SMD	-25	+15	+15	6	32	3	28	1859

CT79E

CT79E SMD

(Extended range)

STANDARD RATINGS - ELECTRICAL CHARACTERISTICS

Capacitance 100Hz +20°C (μ F)	Case (code)	Type		Capacitance maximum change			Max. DF +20°C (%)	Max. Impedance 100Hz -55°C (Ω)	Max. I leak		I _{rms} Max. 40kHz +85°C (mA)
				-55°C (%)	+85°C (%)	+125°C (%)			+20°C (μ A)	+85°C (μ A)	
Rated voltage (+85°C) 6 V - 6,3 V - Category voltage (+125°C) 4 V											
120	A	CT79E	CT79E SMD	-41	+15	+16	21	81	1,5	3	820
150	A	CT79E	CT79E SMD	-42	+16	+16	34	80	2	9	820
160	A	CT79E	CT79E SMD	-42	+16	+16	41	80	2	9	820
220*	A	CT79E	CT79E SMD	-64	+13	+16	50	36	2	9	1000
470	B	CT79E	CT79E SMD	-60	+20	+20	90	46	2	10	1281
560	B	CT79E	CT79E SMD	-68	+20	+20	106	48	2	10	1255
820*	B	CT79E	CT79E SMD	-88	+16	+20	155	18	3	14	1500
1500	C	CT79E	CT79E SMD	-90	+20	+25	172	18	5	20	1900
2200	D	CT79E	CT79E SMD	-90	+25	+25	170	13	6	24	2300
Rated voltage (+85°C) 8 V - Category voltage (+125°C) 5 V											
120	A	CT79E	CT79E SMD	-44	+17,5	+20	32	80	2	6	820
180*	A	CT79E	CT79E SMD	-60	+13	+16	41	45	2	9	1000
430	B	CT79E	CT79E SMD	-64	+17,5	+20	64	54	2	10	1230
680*	B	CT79E	CT79E SMD	-83	+16	+20	130	22	3	14	1500
1500*	C	CT79E	CT79E SMD	-90	+20	+25	170	18	5	20	1900
1800*	D	CT79E	CT79E SMD	-90	+25	+30	138	14	7	25	2300
Rated voltage (+85°C) 10 V - Category voltage (+125°C) 6,3 V											
68	A	CT79E	CT79E SMD	-40	+15	+16	21	85	1,5	3	820
82	A	CT79E	CT79E SMD	-40	+16	+16	25	84	2	6	820
100	A	CT79E	CT79E SMD	-40	+16	+16	30	82	2	6	820
150*	A	CT79E	CT79E SMD	-55	+13	+13	34	54	2	9	900
300	B	CT79E	CT79E SMD	-54	+16	+18	60	52	2	10	1195
330	B	CT79E	CT79E SMD	-54	+17	+18	65	52	2	10	1195
350	B	CT79E	CT79E SMD	-60	+18	+18	68	52	2	10	1195
390	B	CT79E	CT79E SMD	-60	+19	+20	74	54	2	10	1195
470	C	CT79E	CT79E SMD	-65	+18	+20	44	25	2	15	1800
560*	B	CT79E	CT79E SMD	-77	+16	+20	106	27	3	16	1450
850	C	CT79E	CT79E SMD	-84	+25	+25	111	36	4	16	1720
1000	C	CT79E	CT79E SMD	-80	+25	+25	92	36	4	16	1720
1200	C	CT79E	CT79E SMD	-80	+20	+25	137	18	5	20	1850
1500	D	CT79E	CT79E SMD	-88	+25	+30	114	15	7	25	2360
1800	D	CT79E	CT79E SMD	-88	+30	+30	138	24	7	25	2360
2200*	D	CT79E	CT79E SMD	-88	+30	+30	170	22	8	26	2360
Rated voltage (+85°C) 15 V - 16 V - Category voltage (+125°C) 10 V											
47	A	CT79E	CT79E SMD	-28	+16	+16	20	100	1,5	3	760
56	A	CT79E	CT79E SMD	-28	+16	+16	22	100	1,5	3	760
82*	A	CT79E	CT79E SMD	-35	+12	+16	20	43	2	6	915
100*	A	CT79E	CT79E SMD	-44	+13	+16	30	72	2	9	900
220	B	CT79E	CT79E SMD	-35	+16	+16	42	62	2	10	1215
270	B	CT79E	CT79E SMD	-45	+18	+18	55	60	2	12	1215
290	B	CT79E	CT79E SMD	-54	+18	+18	60	65	2	12	1215
330	C	CT79E	CT79E SMD	-58	+18	+20	40	30	2	14	1760
390*	B	CT79E	CT79E SMD	-66	+16	+20	74	31	3	16	1450
680	C	CT79E	CT79E SMD	-80	+25	+25	80	42	5	20	1582
750	C	CT79E	CT79E SMD	-80	+25	+25	95	42	6	24	1582
820	C	CT79E	CT79E SMD	-77	+20	+25	95	22	6	24	1800
850	D	CT79E	CT79E SMD	-80	+25	+25	95	24	8	32	2300
1000	D	CT79E	CT79E SMD	-77	+25	+25	92	17	8	32	2300
1200	D	CT79E	CT79E SMD	-84	+25	+30	103	25	8	32	2300

* out of CECC range

(Extended range)

CT79E

CT79E SMD

STANDARD RATINGS - ELECTRICAL CHARACTERISTICS

Capacitance 100Hz +20°C (μF)	Case (code)	Type	Capacitance maximum change			Max. DF +20°C (%)	Max. Impedance 100Hz -55°C (Ω)	Max. I leak		Irms Max. 40kHz +85°C (mA)	
			-55°C (%)	+85°C (%)	+125°C (%)			+20°C (μA)	+85°C (μA)		
Rated voltage [+85°C] 25 V - Category voltage [+125°C] 16 V											
27	A	CT79E	CT79E SMD	-20	+12	+12	11	140	1,5	3	715
33	A	CT79E	CT79E SMD	-24	+14	+14	13	130	1,5	3	715
39	A	CT79E	CT79E SMD	-28	+16	+16	16	120	2	9	715
43	A	CT79E	CT79E SMD	-28	+16	+16	18	120	2	9	715
68*	A	CT79E	CT79E SMD	-40	+12	+15	22	90	2	9	850
150	B	CT79E	CT79E SMD	-35	+15	+15	32	62	2	10	1130
160	B	CT79E	CT79E SMD	-35	+15	+15	34	60	2	10	1130
180	B	CT79E	CT79E SMD	-48	+14	+15	34	60	2	10	1130
220	C	CT79E	CT79E SMD	-52	+18	+20	33	33	2	13	1614
270*	B	CT79E	CT79E SMD	-62	+13	+16	55	33	2	16	1400
390	C	CT79E	CT79E SMD	-70	+25	+25	48	48	7	28	1396
470	C	CT79E	CT79E SMD	-76	+25	+25	48	48	7	28	1398
540*	C	CT79E	CT79E SMD	-80	+25	+25	60	48	7	28	1398
560	C	CT79E	CT79E SMD	-72	+20	+25	60	24	7	28	1750
680	D	CT79E	CT79E SMD	-72	+25	+25	60	19	8	32	2100
820	D	CT79E	CT79E SMD	-80	+25	+25	82	26	8	32	1862
850	D	CT79E	CT79E SMD	-80	+25	+25	95	26	8	32	1970
Rated voltage [+85°C] 30 V - Category voltage [+125°C] 20 V											
25	A	CT79E	CT79E SMD	-24	+12	+12	11	160	1,5	3	640
33	A	CT79E	CT79E SMD	-30	+12	+14	12	160	2	9	640
47*	A	CT79E	CT79E SMD	-23	+12	+15	20	57	2	6	830
56*	A	CT79E	CT79E SMD	-38	+12	+15	22	100	2	9	800
120	B	CT79E	CT79E SMD	-32	+15	+15	30	60	2	10	1185
150	B	CT79E	CT79E SMD	-35	+15	+15	32	60	2	10	1185
170	B	CT79E	CT79E SMD	-48	+15	+15	34	65	2	12	1185
220*	B	CT79E	CT79E SMD	-60	+13	+16	42	36	3	16	1200
300	C	CT79E	CT79E SMD	-60	+15	+15	43	44	6	24	1559
330	C	CT79E	CT79E SMD	-65	+25	+25	45	52	6	24	1373
350	C	CT79E	CT79E SMD	-70	+25	+25	48	52	8	32	1477
390	C	CT79E	CT79E SMD	-75	+25	+25	55	52	8	32	1477
430	C	CT79E	CT79E SMD	-80	+25	+25	60	54	8	32	1477
470*	C	CT79E	CT79E SMD	-65	+20	+25	64	25	8	32	1500
560	D	CT79E	CT79E SMD	-65	+25	+30	40	20	9	36	2000
Rated voltage [+85°C] 40 V - Category voltage [+125°C] 25 V											
15	A	CT79E	CT79E SMD	-20	+10	+12	7	140	1	2	660
18	A	CT79E	CT79E SMD	-20	+12	+12	10	200	1,5	4	580
22	A	CT79E	CT79E SMD	-24	+12	+12	11	190	1,5	4	580
33*	A	CT79E	CT79E SMD	-20	+10	+12	12	88	3	8	795
68	B	CT79E	CT79E SMD	-24	+13	+15	15	60	1	8	1285
100	B	CT79E	CT79E SMD	-40	+15	+15	25	60	2	10	1285
120	B	CT79E	CT79E SMD	-32	+15	+15	30	62	2	12	1241
150	C	CT79E	CT79E SMD	-48	+14	+15	23	35	2	12	1525
270	C	CT79E	CT79E SMD	-60	+25	+25	37	52	7	28	1373
330	C	CT79E	CT79E SMD	-65	+25	+25	43	52	8	32	1373
390	D	CT79E	CT79E SMD	-75	+25	+25	43	30	8	32	1900
470	D	CT79E	CT79E SMD	-80	+25	+25	45	30	9	36	1900
Rated voltage [+85°C] 50 V - Category voltage [+125°C] 30 V											
18	A	CT79E	CT79E SMD	-24	+12	+12	10	200	1,5	3	580
22	A	CT79E	CT79E SMD	-24	+12	+12	11	190	2	9	580
33*	A	CT79E	CT79E SMD	-29	+10	+12	12	135	2	9	700
100	B	CT79E	CT79E SMD	-40	+15	+15	25	67	3	15	1150
120*	B	CT79E	CT79E SMD	-42	+12	+15	22,5	49	4	24	1200
270	C	CT79E	CT79E SMD	-46	+20	+25	37	29	8	32	1450
330*	D	CT79E	CT79E SMD	-46	+25	+30	38	22	9	36	1900
350	D	CT79E	CT79E SMD	-70	+25	+25	40	30	9	36	1900
390	D	CT79E	CT79E SMD	-75	+25	+25	43	30	9	36	1900
430	D	CT79E	CT79E SMD	-80	+25	+25	45	31	10	40	1900

* out of CECC range

CT79E

CT79E SMD

(Extended range)

STANDARD RATINGS - ELECTRICAL CHARACTERISTICS

Capacitance 100Hz +20°C (μF)	Case (code)	Type	Capacitance maximum change			Max. DF +20°C (%)	Max. Impedance 100Hz -55°C (Ω)	Max. I leak		I _{rms} Max. 40kHz +85°C (mA)	
			-55°C (%)	+85°C (%)	+125°C (%)			+20°C (μA)	+85°C (μA)		
Rated voltage (+85°C) 60 V - 63 V - Category voltage (+125°C) 40 V											
10	A	CT79E	CT79E SMD	-20	+8	+9	4	250	1	2	572
12	A	CT79E	CT79E SMD	-20	+8	+9	7	233	2	4	572
15	A	CT79E	CT79E SMD	-22	+9	+9	8	220	2	9	562
27*	A	CT79E	CT79E SMD	-24	+10	+12	10	144	3	12	700
47	B	CT79E	CT79E SMD	-24	+13	+15	13	70	1	9	1150
56	B	CT79E	CT79E SMD	-26	+14	+15	18	72	2	12	1150
82	B	CT79E	CT79E SMD	-36	+15	+15	22	70	2	12	1150
100*	B	CT79E	CT79E SMD	-36	+12	+15	19	54	4	20	1100
100	C	CT79E	CT79E SMD	-37	+14	+15	18	42	2	11	1420
120	C	CT79E	CT79E SMD	-40	+18	+18	20	49	3	18	1420
220	C	CT79E	CT79E SMD	-40	+16	+20	30	29	8	32	1400
270	D	CT79E	CT79E SMD	-45	+20	+25	26	23	9	36	1850
330	D	CT79E	CT79E SMD	-72	+25	+25	32	31	10	40	1850
Rated voltage (+85°C) 75 V - 80 V - Category voltage (+125°C) 50 V											
8,2	A	CT79E	CT79E SMD	-22	+9	+9	6	280	1,5	3	610
9	A	CT79E	CT79E SMD	-22	+9	+9	6	280	2	4	572
22*	A	CT79E	CT79E SMD	-19	+10	+12	8,5	157	3	12	600
43	B	CT79E	CT79E SMD	-24	+10,5	+12	15	89	2	10	1051
47	B	CT79E	CT79E SMD	-30	+14	+14	15	87	2	10	1051
56	B	CT79E	CT79E SMD	-28	+10,5	+15	11	72	2	12	1051
68	B	CT79E	CT79E SMD	-36	+15	+15	21	86	2	12	1051
82*	B	CT79E	CT79E SMD	-30	+12	+15	15	63	4	24	1000
82	C	CT79E	CT79E SMD	-32	+14	+15	15	45	2	10	1335
100	C	CT79E	CT79E SMD	-36	+17	+18	19	60	8	32	1335
150	C	CT79E	CT79E SMD	-40	+20	+20	25	60	9	36	1335
180	C	CT79E	CT79E SMD	-35	+16	+20	28	30	9	36	1335
220	D	CT79E	CT79E SMD	-40	+20	+22	24,4	24	10	40	1850
250	D	CT79E	CT79E SMD	-68	+25	+25	40	33	10	40	1850
270*	D	CT79E	CT79E SMD	-68	+25	+25	42	35	11	44	1850
Rated voltage (+85°C) 100 V - Category voltage (+125°C) 65 V											
5,6	A	CT79E	CT79E SMD	-17	+8	+8	6	475	2	5	530
10*	A	CT79E	CT79E SMD	-17	+10	+12	4,5	200	3	12	800
30	B	CT79E	CT79E SMD	-16	+8	+8	10	99	3	15	1065
33	B	CT79E	CT79E SMD	-16	+8	+8	14	95	3	15	1065
39	B	CT79E	CT79E SMD	-20	+12	+12	10	80	2	12	1300
56	C	CT79E	CT79E SMD	-28	+14	+15	11	60	2	10	1335
68	C	CT79E	CT79E SMD	-30	+14	+15	11,3	40	10	40	1600
100	D	CT79E	CT79E SMD	-35	+20	+20	11	36	3	24	1859
120*	D	CT79E	CT79E SMD	-35	+15	+17	25	30	12	48	2000
Rated voltage (+85°C) 125 V - Category voltage (+125°C) 85 V											
6,8*	A	CT79E	CT79E SMD	-14	+10	+12	6	300	3	12	700
18	B	CT79E	CT79E SMD	-16	+8	+8	8	133	2	10	1065
27*	B	CT79E	CT79E SMD	-18	+12	+15	7,2	90	5	24	1200
39	C	CT79E	CT79E SMD	-16	+8	+8	8	90	2	10	1282
47	C	CT79E	CT79E SMD	-23	+10	+10	7,9	50	2	10	1500
68	D	CT79E	CT79E SMD	-24	+15	+15	8	42	3	26	1859
82	D	CT79E	CT79E SMD	-24	+15	+17	10	32	3	24	1900
Rated voltage (+85°C) 150 V - Category voltage (+125°C) 100 V											
2,5*	A	CT79E	CT79E SMD	-16	+8	+8	3	780	1	3	495
3,3*	A	CT79E	CT79E SMD	-16	+8	+8	3	600	1	3	495
14*	B	CT79E	CT79E SMD	-16	+8	+8	10	167	2	10	1065
18*	B	CT79E	CT79E SMD	-16	+8	+8	10	133	2	10	1065
25*	C	CT79E	CT79E SMD	-16	+8	+8	20	93	2	20	1335
47*	C	CT79E	CT79E SMD	-24	+10	+10	20	70	2	20	1335
56*	D	CT79E	CT79E SMD	-24	+15	+15	30	47	3	30	1860
82*	D	CT79E	CT79E SMD	-24	+18	+18	30	39	3	30	1860

* out of CECC range

CT79 HT200

CT79E HT200



Wet tantalum capacitors
Hermetically sealed tantalum cases
High ripple current
High temperature +200°C
 Axial leads
 Polarized

ELECTRICAL AND CLIMATIC CHARACTERISTICS

	CT79 HT200	CT79E HT200
Detail specification	According to CECC 30202-801 According to CECC 30202-005 According to CECC 30202-001	According to CECC 30202-801 According to CECC 30202-005 According to CECC 30202-001
Operating temperature	-55°C +200°C	-55°C +200°C
Damp heat	56 days	56 days
Capacitance range	1,7µF...1200µF	5,6µF ⇒ 2200µF
Tolerance	±10% - ±20%	±10% - ±20%
Voltage range	6V ⇒ 125V	6V ⇒ 150V
Max. capacitance change at -55°C	see table	see table
Max. capacitance change at +85°C	see table	see table
Max. capacitance change at +125°C	see table	see table
Maximum DF at +20°C	see table	see table
Maximum DF at +85°C	= lim20°C	= lim20°C
Maximum DF at +125°C	= lim20°C	= lim20°C
Max. Impedance (100Hz) at -55°C	see table	see table
Max. leakage current at +20°C	see table	see table
Max. leakage current at +85°C	see table	see table
Max. leakage current at +125°C	= lim85°C	= lim85°C
Max. leakage current at +175°C	= 1,1 x lim85°C	= 1,1 x lim85°C
Max. leakage current at +200°C	= 1,1 x lim85°C	= 1,1 x lim85°C
Max. ripple current 40kHz +85°C	see table	see table
Max. Reverse voltage at +20°C	3 volts	3 volts
Max. Reverse voltage at +85°C	3 volts	3 volts
Max. Reverse voltage at +125°C	3 volts	3 volts
Max. surge voltage at +85°C	1,15 x U _R	1,15 x U _R
Max. surge voltage at +125°C	1,15 x U _C	1,15 x U _C

DIMENSIONS (mm)

Case code	Dimensions with insulating sleeve		
	L max	D max	d +10% -0,05
A	18	5,6	0,6
B	23	7,4	0,6
C	26	10,1	0,6
D	34	10,1	0,6

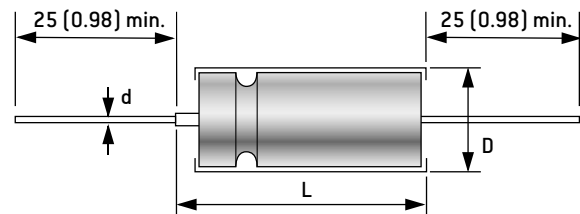

MARKING, PACKAGING, CONSTRUCTION:

see general characteristics

HOW TO ORDER

Commercial description	Model		Case	Capacitance in µF	Tolerance in %	DC Voltage	Termination
		CT79 HT200	CT79E HT200	D	850µF	20%	25V
EXXELIA PN	Model code		Case	Capacitance code	Tolerance code	DC Voltage code	Termination
	TS79H	TS79EH	D	857	M	025	A
	Expressed in pF with 3 digits: 2 digits for the value and the third for the multiplier			K = 10% M = 20%	Expressed in volt with 3 digits	Commercial description H = SnPb (non RoHS) - = Sn100% (RoHS)	EXXELIA PN A = SnPb (non RoHS) F = Sn100% (RoHS)

CT79 HT200

(High temperature standard range)

STANDARD RATINGS - ELECTRICAL CHARACTERISTICS

Capacitance 100Hz +20°C (μ F)	Case (code)	Type	Capacitance maximum change			Max. DF +20°C (%)	Max. Impedance 100Hz -55°C (Ω)	Max. I leak		I _{rms} Max. 40kHz +85°C (mA)
			-55°C (%)	+85°C (%)	+125°C (%)			+20°C (μ A)	+85°C (μ A)	
Rated voltage 6 V - 6,3 V (+85°C) - 4 V (+125°C) - 3,8 V (+175°C) - 3,6 V (+200°C)										
30	A	CT79 HT200	-40	+10	+12	9	100	1	1,8	820
68	A	CT79 HT200	-40	+10	+12	15	55	1	1,8	960
140	B	CT79 HT200	-40	+10	+12	21	40	1	2,8	1200
220	B	CT79 HT200	-44	+16	+18	36	30	1	5,9	1370
270	B	CT79 HT200	-44	+17	+20	41	25	1	5,9	1375
330	C	CT79 HT200	-44	+14	+16	36	20	1,8	7,3	1800
560	C	CT79 HT200	-64	+18	+20	50	25	1,8	11,9	1900
1000	D	CT79 HT200	-80	+25	+25	68	22	2,8	12,8	2388
1200	D	CT79 HT200	-80	+25	+25	86	20	2,8	12,8	2388
Rated voltage 8 V (+85°C) - 5 V (+125°C) - 4,9 V (+175°C) - 4,8 V (+200°C)										
25	A	CT79 HT200	-40	+11	+12	7,5	100	1	1,8	820
56	A	CT79 HT200	-40	+14	+16	14	59	1	1,8	900
120	B	CT79 HT200	-44	+18	+20	20	50	1	2,8	1230
220	B	CT79 HT200	-44	+16	+18	37	30	1	6,4	1370
290	C	CT79 HT200	-64	+18	+20	34	25	1,8	5,5	1770
430	C	CT79 HT200	-64	+18	+20	46	25	1,8	12,8	1825
850	D	CT79 HT200	-80	+25	+25	60	22	1,8	14,6	2456
Rated voltage 10 V (+85°C) - 6,7 V (+125°C) - 6,5 V (+175°C) - 6 V (+200°C)										
20	A	CT79 HT200	-32	+11	+12	6	175	1	1,8	820
47	A	CT79 HT200	-36	+14	+16	13	100	1	1,8	855
100	B	CT79 HT200	-36	+14	+16	15	60	1	3,7	1200
150	B	CT79 HT200	-32	+14	+16	28	45	1	6,4	1271
180	B	CT79 HT200	-35	+14	+16	29	40	1	6,4	1365
250	C	CT79 HT200	-40	+14	+16	30	30	1,8	9	1720
390	C	CT79 HT200	-64	+18	+20	44	25	1,8	13,5	1800
680	D	CT79 HT200	-80	+25	+25	42	20	2,7	14,5	2487
750	D	CT79 HT200	-80	+25	+25	50	23	2,7	14,5	2487
820	D	CT79 HT200	-80	+25	+25	53	22	2,7	14,5	2360
Rated voltage 15 V - 16 V (+85°C) - 10 V (+125°C) - 9,5 V (+175°C) - 9 V (+200°C)										
15	A	CT79 HT200	-24	+11	+12	5	155	1	1,8	780
33	A	CT79 HT200	-28	+14	+16	10	90	1	1,8	820
70	B	CT79 HT200	-28	+14	+16	13	75	1	3,7	1150
120	B	CT79 HT200	-28	+14	+16	18	50	1	6,4	1450
170	C	CT79 HT200	-32	+14	+16	25	35	1,8	9	1480
220	C	CT79 HT200	-41	+13	+15	21	40	1,8	5,5	1490
270	C	CT79 HT200	-56	+18	+20	32	30	1,8	12,8	1740
330	C	CT79 HT200	-58	+18	+20	40	30	1,8	12,8	1760
470	D	CT79 HT200	-75	+25	+25	33	24	2,7	16,4	2100
540	D	CT79 HT200	-80	+25	+25	40	23	2,7	16,4	2300
560	D	CT79 HT200	-80	+25	+25	36	23	2,7	16,4	2300
Rated voltage 25 V (+85°C) - 16 V (+125°C) - 15,5 V (+175°C) - 15 V (+200°C)										
10	A	CT79 HT200	-16	+8	+9	4	220	1	1,8	715
22	A	CT79 HT200	-20	+10	+12	6,6	140	1	1,8	825
50	B	CT79 HT200	-28	+13	+15	11	70	1	1,8	1130
100	B	CT79 HT200	-28	+13	+15	15	50	1	8,1	1435
120	C	CT79 HT200	-32	+13	+15	21	58	1,8	5,5	1450
180	C	CT79 HT200	-48	+13	+15	26	32	1,8	12,8	1700
330	D	CT79 HT200	-60	+25	+25	28	27	2,7	18	2000
350	D	CT79 HT200	-64	+25	+25	35	24	2,7	18	2246
390	D	CT79 HT200	-68	+25	+25	32	24	2,7	18	2025
560	D	CT79 HT200	-65	+25	+30	46	15	8,1	32,8	2040
Rated voltage 30 V (+85°C) - 20 V (+125°C) - 19 V (+175°C) - 18 V (+200°C)										
8	A	CT79 HT200	-16	+8	+12	4	275	1	1,8	640
15	A	CT79 HT200	-20	+10	+12	5	175	1	1,8	780
40	B	CT79 HT200	-24	+11	+12	10	65	1	4,6	1120
68	B	CT79 HT200	-24	+13	+15	13	60	1	7,2	1285
100	C	CT79 HT200	-28	+11	+12	17	40	1,8	10,8	1477
150	C	CT79 HT200	-48	+13	+15	23	35	1,8	10,8	1525
300	D	CT79 HT200	-60	+25	+25	30	25	2,7	18	2100

(High temperature standard range)

CT79 HT200

STANDARD RATINGS - ELECTRICAL CHARACTERISTICS

Capacitance 100Hz +20°C (μ F)	Case (code)	Type	Capacitance maximum change			Max. DF +20°C (%)	Max. Impedance 100Hz -55°C (Ω)	Max. I leak		I _{rms} Max. 40kHz +85°C (mA)
			-55°C (%)	+85°C (%)	+125°C (%)			+20°C (μ A)	+85°C (μ A)	
Rated voltage 40 V (+85°C) - 26 V (+125°C) - 25 V (+175°C) - 24 V (+200°C)										
12	A	CT79 HT200	-24,0	+8,0	+10,0	6	234	1	1,8	450
56	B	CT79 HT200	-24,0	+13,0	+15,0	14	78	1	8,1	1100
100	C	CT79 HT200	-40,0	+13,0	+15,0	18	48	1,8	15,3	1450
220	B	CT79 HT200	-55,0	+23,0	+23,0	22	27	2,7	19,8	1900
Rated voltage 50 V (+85°C) - 33 V (+125°C) - 32 V (+175°C) - 30 V (+200°C)										
5	A	CT79 HT200	-16,0	+5,0	+6,0	3	400	1	1,8	580
10	A	CT79 HT200	-20,0	+8,0	+9,0	4	250	1	1,8	715
25	B	CT79 HT200	-20,0	+10,5	+12,0	8	95	1	4,6	1065
47	B	CT79 HT200	-24,0	+13,0	+15,0	11	70	1	8,1	1215
60	C	CT79 HT200	-16,0	+10,5	+12,0	12	45	1,8	10,8	1335
82	C	CT79 HT200	-32,0	+13,0	+15,0	15	45	1,8	9,1	1460
160	D	CT79 HT200	-50,0	+23,0	+23,0	17	27	2,7	19,8	2040
Rated voltage 60 V - 63 V (+85°C) - 40 V (+125°C) - 39 V (+175°C) - 36 V (+200°C)										
4	A	CT79 HT200	-16,0	+5,0	+6,0	2,8	550	1	1,8	525
8,2	A	CT79 HT200	-20,0	+8,0	+9,0	4	275	1	1,8	625
20	B	CT79 HT200	-16,0	+10,5	+12,0	7	105	1	4,6	1026
39	B	CT79 HT200	-24,0	+10,0	+12,0	10	90	1	8,1	1185
50	C	CT79 HT200	-16,0	+10,5	+12,0	10	50	1,8	10,8	1341
68	C	CT79 HT200	-30,0	+10,5	+12,0	13	50	1,8	9,1	1393
140	D	CT79 HT200	-40,0	+20,0	+20,0	16	28	2,7	19,8	1990
150	D	CT79 HT200	-40,0	+20,0	+20,0	17	27	2,7	19,8	1865
Rated voltage 75 V - 80 V (+85°C) - 50 V (+125°C) - 48 V (+175°C) - 45 V (+200°C)										
3,5	A	CT79 HT200	-16,0	+5,0	+6,0	2,5	650	1	1,8	525
6,8	A	CT79 HT200	-20,0	+8,0	+9,0	3	300	1	1,8	610
15	B	CT79 HT200	-16,0	+8,0	+9,0	6	150	1	4,6	1000
33	B	CT79 HT200	-24,0	+10,0	+12,0	10	90	1	8,1	1079
40	C	CT79 HT200	-16,0	+10,5	+12,0	9	60	1,8	10,8	1293
56	C	CT79 HT200	-28,0	+10,5	+15,0	11	60	1,8	9,1	1396
68	C	CT79 HT200	-30,0	+14,0	+15,0	13	50	1,8	9,1	1522
100	D	CT79 HT200	-35,0	+20,0	+20,0	12	36	8,2	32,7	1500
110	D	CT79 HT200	-35,0	+20,0	+20,0	11	29	2,7	21,8	1990
120	D	CT79 HT200	-36,0	+20,0	+20,0	12	28	2,7	21,8	1914
150	D	CT79 HT200	-48,0	+21,0	+22,0	17	30	8,2	32,7	1914
Rated voltage 100 V (+85°C) - 65 V (+125°C) - 63 V (+175°C) - 60 V (+200°C)										
2,5	A	CT79 HT200	-16,0	+7,0	+8,0	2	950	1	1,8	505
4,7	A	CT79 HT200	-16,0	+7,0	+8,0	3	500	1	1,8	565
11	B	CT79 HT200	-16,0	+8,0	+8,0	5	200	1	3,6	835
22	B	CT79 HT200	-16,0	+7,0	+8,0	7,5	100	1	8,1	1065
30	C	CT79 HT200	-16,0	+8,0	+8,0	7	80	1,8	10,8	1240
33	C	CT79 HT200	-16,0	+8,0	+8,0	7	93	1,8	9,1	1200
39	C	CT79 HT200	-16,0	+8,0	+8,0	8	90	1,8	9,1	1282
43	C	CT79 HT200	-20,0	+8,0	+8,0	8	70	1,8	9,1	1389
47	C	CT79 HT200	-20,0	+7,0	+8,0	8	70	1,8	9,1	1859
68	D	CT79 HT200	-24,0	+15,0	+15,0	8	42	2,7	23,6	1859
82	D	CT79 HT200	-24,0	+15,0	+15,0	10	39	2,7	21,8	1859
86	D	CT79 HT200	-24,0	+15,0	+15,0	10	30	2,7	21,8	1859
Rated voltage 125 V (+85°C) - 85 V (+125°C) - 80 V (+175°C) - 75 V (+200°C)										
1,7	A	CT79 HT200	-16,0	+7,0	+8,0	2	1250	1	1,8	415
2,2	A	CT79 HT200	-16,0	+7,0	+8,0	2	1250	1	1,8	452
2,7	A	CT79 HT200	-16,0	+7,0	+8,0	3	780	1	1,8	452
3,3	A	CT79 HT200	-16,0	+7,0	+8,0	3	600	1	1,8	495
3,6	A	CT79 HT200	-16,0	+7,0	+8,0	2,7	600	1	1,8	520
3,9	A	CT79 HT200	-16,0	+7,0	+8,0	3,5	557	1	1,8	495
9	B	CT79 HT200	-16,0	+7,0	+8,0	5	240	1	4,5	755
14	B	CT79 HT200	-16,0	+7,0	+8,0	6	167	1	6,4	1050
15	B	CT79 HT200	-16,0	+7,0	+8,0	6	167	1	6,4	1050
18	C	CT79 HT200	-16,0	+7,0	+8,0	5	129	1,8	8,1	1130
25	C	CT79 HT200	-16,0	+7,0	+8,0	6	93	1,8	9,1	1335
27	C	CT79 HT200	-16,0	+7,0	+8,0	6	106	1,8	11,8	1282
56	D	CT79 HT200	-25,0	+15,0	+15,0	6	32	2,7	25,5	1859

CT79E HT200

(High temperature extended range)

STANDARD RATINGS - ELECTRICAL CHARACTERISTICS

Capacitance 100Hz +20°C (μ F)	Case (code)	Type	Capacitance maximum change			Max. DF +20°C (%)	Max. Impedance 100Hz -55°C (Ω)	Max. I leak		I _{rms} Max. 40kHz +85°C (mA)
			-55°C (%)	+85°C (%)	+125°C (%)			+20°C (μ A)	+85°C (μ A)	
Rated voltage 6 V - 6,3 V (+85°C) - 4 V (+125°C) - 3,8 V (+175°C) - 3,6 V (+200°C)										
120	A	CT79E HT200	-41	+15,0	+16,0	21	81	1,4	2,7	820
150	A	CT79E HT200	-42	+16,0	+16,0	34	80	1,8	8,1	820
160	A	CT79E HT200	-42	+16,0	+16,0	41	80	1,8	8,1	820
220	A	CT79E HT200	-64	+13,0	+16,0	50	36	1,8	8,1	1000
470	B	CT79E HT200	-60	+20,0	+20,0	90	46	1,8	9,0	1281
560	B	CT79E HT200	-68	+20,0	+20,0	106	48	1,8	9,0	1255
820	B	CT79E HT200	-88	+16,0	+20,0	155	18	2,7	12,6	1500
1500	C	CT79E HT200	-90	+20,0	+25,0	172	18	4,5	18,0	1900
2200	D	CT79E HT200	-90	+25,0	+25,0	170	13	5,4	21,8	2300
Rated voltage 8 V (+85°C) - 5 V (+125°C) - 4,9 V (+175°C) - 4,8 V (+200°C)										
120	A	CT79E HT200	-44	+17,5	+20,0	32	80	1,8	5,4	820
180	A	CT79E HT200	-60	+13,0	+16,0	41	45	1,8	8,1	1000
430	B	CT79E HT200	-64	+17,5	+20,0	64	54	1,8	9,0	1230
680	B	CT79E HT200	-83	+16,0	+20,0	130	22	2,7	12,6	1500
1500	C	CT79E HT200	-90	+20,0	+25,0	170	18	4,5	18,0	1900
1800	D	CT79E HT200	-90	+25,0	+30,0	138	14	5,4	22,7	2300
Rated voltage 10 V (+85°C) - 6,7 V (+125°C) - 6,5 V (+175°C) - 6 V (+200°C)										
68	A	CT79E HT200	-40	+15,0	+16,0	21	85	1,4	2,7	820
82	A	CT79E HT200	-40	+16,0	+16,0	25	84	1,8	5,4	820
100	A	CT79E HT200	-40	+16,0	+16,0	30	82	1,8	5,4	820
150	A	CT79E HT200	-55	+13,0	+13,0	34	54	1,8	8,1	900
300	B	CT79E HT200	-54	+16,0	+18,0	60	52	1,8	9,0	1195
330	B	CT79E HT200	-54	+17,0	+18,0	65	52	1,8	9,0	1195
350	B	CT79E HT200	-60	+18,0	+18,0	68	52	1,8	9,0	1195
390	B	CT79E HT200	-60	+19,0	+20,0	74	54	1,8	9,0	1195
470	C	CT79E HT200	-65	+18,0	+20,0	44	25	1,8	13,5	1800
560	B	CT79E HT200	-77	+16,0	+20,0	106	27	2,7	14,4	1450
850	C	CT79E HT200	-84	+25,0	+25,0	111	36	3,6	14,4	1720
1000	C	CT79E HT200	-80	+25,0	+25,0	92	36	3,6	14,4	1720
1200	C	CT79E HT200	-80	+20,0	+25,0	137	18	4,6	18,0	1850
1500	D	CT79E HT200	-88	+25,0	+30,0	114	15	6,3	22,5	2360
1800	D	CT79E HT200	-88	+30,0	+30,0	138	24	6,3	22,5	2360
2200	D	CT79E HT200	-88	+30,0	+30,0	170	22	7,2	23,6	2360
Rated voltage 15 V - 16 V (+85°C) - 10 V (+125°C) - 9,5 V (+175°C) - 9 V (+200°C)										
47	A	CT79E HT200	-28	+16,0	+16,0	20	100	1,4	2,7	760
56	A	CT79E HT200	-28	+16,0	+16,0	22	100	1,4	2,7	760
82	A	CT79E HT200	-35	+12,0	+16,0	20	43	1,8	5,4	915
100	A	CT79E HT200	-44	+13,0	+16,0	30	72	1,8	8,1	900
220	B	CT79E HT200	-35	+16,0	+16,0	42	62	1,8	9,0	1215
270	B	CT79E HT200	-45	+18,0	+18,0	55	60	1,8	10,8	1215
290	B	CT79E HT200	-54	+18,0	+18,0	60	65	1,8	10,8	1215
330	C	CT79E HT200	-58	+18,0	+20,0	40	30	1,8	12,6	1760
390	B	CT79E HT200	-66	+16,0	+20,0	74	31	2,7	14,4	1450
680	C	CT79E HT200	-80	+25,0	+25,0	80	42	4,6	18,0	1582
750	C	CT79E HT200	-80	+25,0	+25,0	95	42	5,4	22,7	1582
820	C	CT79E HT200	-77	+20,0	+25,0	95	22	5,4	22,7	1800
850	D	CT79E HT200	-80	+25,0	+25,0	95	24	7,2	28,8	1300
1000	D	CT79E HT200	-77	+25,0	+25,0	92	17	7,2	28,8	2300
1200	D	CT79E HT200	-84	+25,0	+30,0	103	25	7,2	28,8	2300

[High temperature extended range]

CT79E HT200

STANDARD RATINGS - ELECTRICAL CHARACTERISTICS

Capacitance 100Hz +20°C (μ F)	Case (code)	Type	Capacitance maximum change			Max. DF +20°C (%)	Max. Impedance 100Hz -55°C (Ω)	Max. I leak		I _{rms} Max. 40kHz +85°C (mA)
			-55°C (%)	+85°C (%)	+125°C (%)			+20°C (μ A)	+85°C (μ A)	
Rated voltage 25 V (+85°C) - 16 V (+125°C) - 15,5 V (+175°C) - 15 V (+200°C)										
27	A	CT79E HT200	-20	+12,0	+12,0	11	140	1,4	2,7	715
33	A	CT79E HT200	-24	+14,0	+14,0	13	130	1,4	2,7	715
39	A	CT79E HT200	-28	+16,0	+16,0	16	120	1,8	8,1	715
43	A	CT79E HT200	-28	+16,0	+16,0	18	120	1,8	8,1	715
68	A	CT79E HT200	-40	+12,0	+15,0	22	90	1,8	8,1	850
150	B	CT79E HT200	-35	+15,0	+15,0	32	62	1,8	9,0	1130
160	B	CT79E HT200	-35	+15,0	+15,0	34	60	1,8	9,0	1130
180	B	CT79E HT200	-48	+14,0	+15,0	34	60	1,8	9,0	1130
220	C	CT79E HT200	-52	+18,0	+20,0	33	33	1,8	11,7	1614
270	B	CT79E HT200	-62	+13,0	+16,0	55	33	1,8	14,4	1400
390	C	CT79E HT200	-70	+25,0	+25,0	48	48	6,3	25,2	1396
470	C	CT79E HT200	-76	+25,0	+25,0	48	48	6,3	25,2	1398
540	C	CT79E HT200	-80	+25,0	+25,0	60	48	6,3	25,2	1398
560	C	CT79E HT200	-72	+20,0	+25,0	60	24	6,3	25,2	1750
680	D	CT79E HT200	-72	+25,0	+25,0	60	19	7,2	28,8	2100
820	D	CT79E HT200	-80	+25,0	+25,0	82	26	7,2	28,8	1862
850	D	CT79E HT200	-80	+25,0	+25,0	95	26	7,2	28,8	1970
Rated voltage 30 V (+85°C) - 20 V (+125°C) - 19 V (+175°C) - 18 V (+200°C)										
25	A	CT79E HT200	-24,0	+12,0	+12,0	11	160	1,4	2,7	640
33	A	CT79E HT200	-30,0	+12,0	+14,0	12	160	1,8	8,1	640
47	A	CT79E HT200	-23,0	+12,0	+15,0	20	57	1,8	5,4	830
56	A	CT79E HT200	-38,0	+12,0	+15,0	22	100	1,8	8,1	800
120	B	CT79E HT200	-32,0	+15,0	+15,0	30	60	1,8	9,0	1185
150	B	CT79E HT200	-35,0	+15,0	+15,0	32	60	1,8	9,0	1185
170	B	CT79E HT200	-48,0	+15,0	+15,0	34	65	1,8	10,8	1185
220	B	CT79E HT200	-60,0	+13,0	+16,0	42	36	2,7	14,4	1200
300	C	CT79E HT200	-60,0	+15,0	+15,0	43	44	5,4	22,7	1559
330	C	CT79E HT200	-60,0	+25,0	+25,0	45	52	5,4	22,7	1373
350	C	CT79E HT200	-70,0	+25,0	+25,0	48	52	7,2	28,8	1477
390	C	CT79E HT200	-75,0	+25,0	+25,0	55	52	7,2	28,8	1477
430	C	CT79E HT200	-80,0	+25,0	+25,0	60	54	7,2	28,8	1477
470	C	CT79E HT200	-65,0	+20,0	+25,0	64	25	8,1	32,4	1500
560	D	CT79E HT200	-65,0	+25,0	+30,0	40	20	2,7	18,0	2000
Rated voltage 40 V (+85°C) - 26 V (+125°C) - 25 V (+175°C) - 24 V (+200°C)										
15	A	CT79E HT200	-24,0	+12,0	+12,0	11	160	1,4	2,7	640
18	A	CT79E HT200	-30,0	+12,0	+14,0	12	160	1,8	8,1	640
22	A	CT79E HT200	-23,0	+12,0	+15,0	20	57	1,8	5,4	830
33	A	CT79E HT200	-38,0	+12,0	+15,0	22	100	1,8	8,1	800
68	B	CT79E HT200	-32,0	+15,0	+15,0	30	60	1,8	9,0	1185
100	B	CT79E HT200	-35,0	+15,0	+15,0	32	60	1,8	9,0	1185
120	B	CT79E HT200	-48,0	+15,0	+15,0	34	65	1,8	10,8	1185
150	B	CT79E HT200	-60,0	+13,0	+16,0	42	36	2,7	14,4	1200
270	C	CT79E HT200	-60,0	+15,0	+15,0	43	44	5,4	22,7	1559
330	C	CT79E HT200	-60,0	+25,0	+25,0	45	52	5,4	22,7	1373
390	C	CT79E HT200	-70,0	+25,0	+25,0	48	52	7,2	28,8	1477
470	C	CT79E HT200	-75,0	+25,0	+25,0	55	52	7,2	28,8	1477
Rated voltage 50 V (+85°C) - 33 V (+125°C) - 32 V (+175°C) - 30 V (+200°C)										
18	A	CT79E HT200	-24,0	+12,0	+12,0	10	200	1,4	2,7	580
22	A	CT79E HT200	-24,0	+12,0	+12,0	11	190	1,8	8,1	580
33	A	CT79E HT200	-29,0	+10,0	+12,0	12	135	1,8	8,1	700
100	B	CT79E HT200	-40,0	+15,0	+15,0	25	67	2,7	13,5	1150
120	B	CT79E HT200	-42,0	+12,0	+15,0	22,5	49	3,6	21,6	1200
270	C	CT79E HT200	-46,0	+20,0	+25,0	37	29	7,2	28,8	1450
330	D	CT79E HT200	-46,0	+25,0	+30,0	38	22	8,1	32,4	1900
350	D	CT79E HT200	-70,0	+25,0	+25,0	40	30	8,1	32,4	1900
390	D	CT79E HT200	-75,0	+25,0	+25,0	43	30	8,1	32,4	1900
430	D	CT79E HT200	-80,0	+25,0	+25,0	45	31	9,0	36,0	1900

CT79E HT200

(High temperature extended range)

STANDARD RATINGS - ELECTRICAL CHARACTERISTICS

Capacitance 100Hz +20°C (μ F)	Case (code)	Type	Capacitance maximum change			Max. DF +20°C (%)	Max. Impedance 100Hz -55°C (Ω)	Max. I leak		I _{rms} Max. 40kHz +85°C (mA)
			-55°C (%)	+85°C (%)	+125°C (%)			+20°C (μ A)	+85°C (μ A)	
Rated voltage 60 V - 63 V (+85°C) - 40 V (+125°C) - 39 V (+175°C) - 36 V (+200°C)										
10	A	CT79E HT200	-20,0	+8,0	+9,0	4	250	1	1,8	572
12	A	CT79E HT200	-20,0	+8,0	+9,0	7	233	1,8	3,6	572
15	A	CT79E HT200	-22,0	+9,0	+9,0	8	220	1,8	8,1	562
27	A	CT79E HT200	-24,0	+10,0	+12,0	10	144	2,7	10,8	700
47	B	CT79E HT200	-24,0	+13,0	+15,0	13	70	1	8,1	1150
56	B	CT79E HT200	-26,0	+14,0	+15,0	18	72	1,8	10,8	1150
82	B	CT79E HT200	-36,0	+15,0	+15,0	22	70	1,8	10,8	1150
100	B	CT79E HT200	-36,0	+12,0	+15,0	19	54	3,6	18,0	1100
100	C	CT79E HT200	-37,0	+14,0	+15,0	18	42	1,8	9,9	1420
120	C	CT79E HT200	-40,0	+18,0	+18,0	20	49	2,7	16,2	1420
220	D	CT79E HT200	-40,0	+16,0	+20,0	30	29	7,2	28,8	1400
270	D	CT79E HT200	-45,0	+20,0	+25,0	26	23	8,1	32,4	1850
330	D	CT79E HT200	-72,0	+25,0	+25,0	32	31	9,0	36,0	1850
Rated voltage 75 V - 80 V (+85°C) - 50 V (+125°C) - 48 V (+175°C) - 45 V (+200°C)										
8,2	A	CT79E HT200	-22,0	+9,0	+9,0	6	280	1,4	2,7	610
9	A	CT79E HT200	-22,0	+9,0	+9,0	6	280	1,8	3,6	572
22	A	CT79E HT200	-19,0	+10,0	+12,0	8,5	157	2,7	10,8	600
43	B	CT79E HT200	-24,0	+10,5	+12,0	15	89	1,8	9,0	1051
47	B	CT79E HT200	-30,0	+14,0	+14,0	15	87	1,8	9,0	1051
56	B	CT79E HT200	-28,0	+10,5	+15,0	11	72	1,8	10,8	1051
68	B	CT79E HT200	-36,0	+15,0	+15,0	21	86	1,8	10,8	1051
82	B	CT79E HT200	-30,0	+12,0	+15,0	15	63	3,6	21,6	1000
82	C	CT79E HT200	-32,0	+14,0	+15,0	15	45	1,8	9,0	1335
100	C	CT79E HT200	-36,0	+17,0	+18,0	19	60	7,2	28,8	1335
150	C	CT79E HT200	-40,0	+20,0	+20,0	25	60	8,1	32,4	1335
180	C	CT79E HT200	-35,0	+16,0	+20,0	28	30	8,1	32,4	1335
220	D	CT79E HT200	-40,0	+20,0	+22,0	24,4	24	9,0	36,0	1850
250	D	CT79E HT200	-68,0	+25,0	+25,0	40	33	9,0	36,0	1850
270	D	CT79E HT200	-68,0	+25,0	+25,0	42	35	10,0	40,0	1850
Rated voltage 100 V (+85°C) - 65 V (+125°C) - 63 V (+175°C) - 60 V (+200°C)										
5,6	A	CT79E HT200	-17,0	+8,0	+8,0	6	475	1,8	4,5	530
10	A	CT79E HT200	-17,0	+10,0	+12,0	4,5	200	2,7	10,8	800
30	B	CT79E HT200	-16,0	+8,0	+8,0	10	99	2,7	13,5	1065
33	B	CT79E HT200	-16,0	+8,0	+8,0	14	95	2,7	13,5	1065
39	B	CT79E HT200	-20,0	+12,0	+12,0	10	80	1,8	10,8	1300
56	C	CT79E HT200	-28,0	+14,0	+15,0	11	60	1,8	9,1	1335
68	C	CT79E HT200	-30,0	+14,0	+15,0	11,3	40	9,0	36,0	1600
100	D	CT79E HT200	-35,0	+20,0	+20,0	11	36	2,7	21,6	1859
120	D	CT79E HT200	-35,0	+15,0	+17,0	25	30	10,8	43,2	2000
Rated voltage 125 V (+85°C) - 85 V (+125°C) - 80 V (+175°C) - 75 V (+200°C)										
6,8	A	CT79E HT200	-14,0	+10,0	+12,0	6	300	2,7	10,8	700
18	B	CT79E HT200	-16,0	+8,0	+8,0	8	133	1,8	9,0	1065
27	B	CT79E HT200	-18,0	+12,0	+15,0	7,2	90	4,5	21,6	1200
39	C	CT79E HT200	-16,0	+8,0	+8,0	8	90	1,8	9,0	1282
47	C	CT79E HT200	-23,0	+10,0	+10,0	7,9	50	1,8	9,0	1500
68	D	CT79E HT200	-24,0	+15,0	+15,0	8	42	2,7	23,4	1859
82	D	CT79E HT200	-24,0	+15,0	+17,0	10	32	2,7	21,6	1900
Rated voltage 150 V (+85°C) - 100 V (+125°C) - 95 V (+175°C) - 90 V (+200°C)										
2,5	A	CT79E HT200	-16,0	+8,0	+8,0	3	780	1	2,7	495
3,3	A	CT79E HT200	-16,0	+8,0	+8,0	3	600	1	2,7	495
14	B	CT79E HT200	-16,0	+8,0	+8,0	10	167	1,8	9,0	1065
18	B	CT79E HT200	-16,0	+8,0	+8,0	10	133	1,8	9,0	1065
25	C	CT79E HT200	-16,0	+8,0	+8,0	20	93	1,8	18,0	1335
47	C	CT79E HT200	-24,0	+10,0	+10,0	20	70	1,8	18,0	1335
56	D	CT79E HT200	-24,0	+15,0	+15,0	30	47	2,7	27,0	1860
82	D	CT79E HT200	-24,0	+18,0	+18,0	30	39	2,7	27,0	1860

CT79E HT200

DERATING

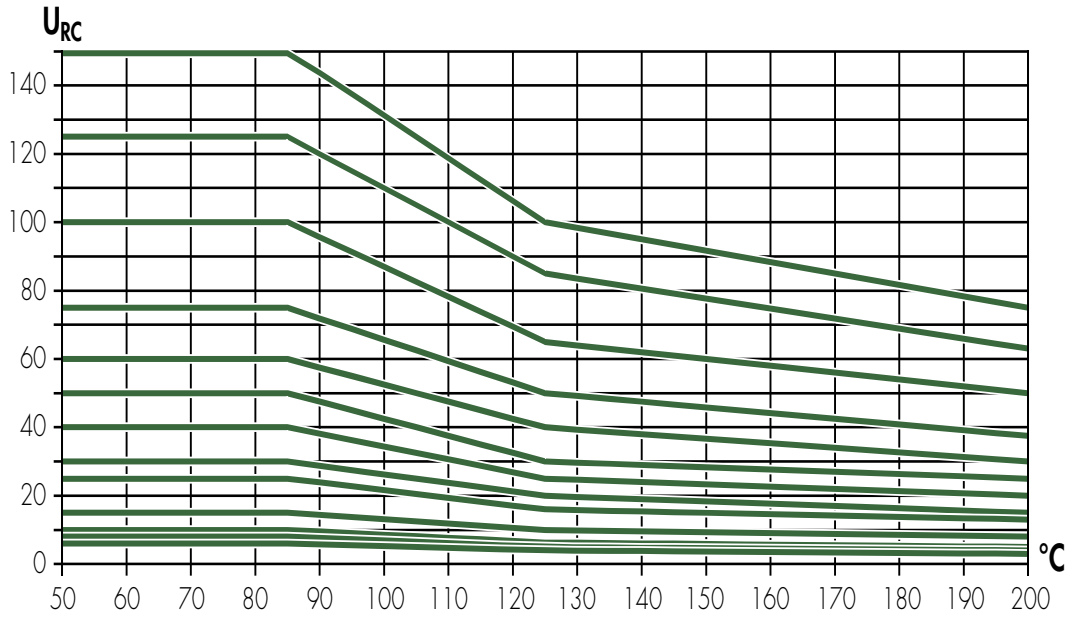

ST79



Wet tantalum capacitors
Hermetically sealed tantalum cases
High capacitance
Very high ripple current
 Axial leads
 Polarized

ELECTRICAL AND CLIMATIC CHARACTERISTICS

	ST79
Detail specification	According to DSCC DWG No. 93026 ESCC 3003/006 ESA/ESCC EPPL2
Operating temperature	-55°C + 125°C
Damp heat	56 days
Capacitance range	10µF ⇒ 1800µF
Tolerance	± 10% - ± 20%
Voltage range	25V ⇒ 125V
Max. capacitance change -55°C	see table
Max. capacitance change +85°C	see table
Max. capacitance change +125°C	see table
Maximum DF at +20°C	see table
Maximum DF at +85°C	= lim20°C
Maximum DF at +125°C	= lim20°C
Max. impedance (100Hz) at -55°C	see table
Max. leakage current at +20°C	see table
Max. leakage current at +85°C	see table
Max. leakage current at +125°C	= lim+85°C
Max. ESR at 100Hz +25°C	see table
Max. ESR at 40kHz +25°C	see table
Max. ripple current 40kHz +85°C	see table
Reverse voltage	No continuous Reverse voltage. Reverse voltage is acceptable under some conditions: $U_{REV} \leq 1,5 V$, $I_t \leq 0,05 A$ second and repetition rate < 10Hz
Max. surge voltage at +85°C	$1,15 \times U_R$
Max. surge voltage at +125°C	$1,15 \times U_C$

DIMENSIONS (mm)

Case code	Dimensions with insulating sleeve		
	L max	D max	d +10% -0,05
A	18	5,6	0,6
B	23	7,4	0,6
C	26	10,1	0,6
D	34	10,1	0,6

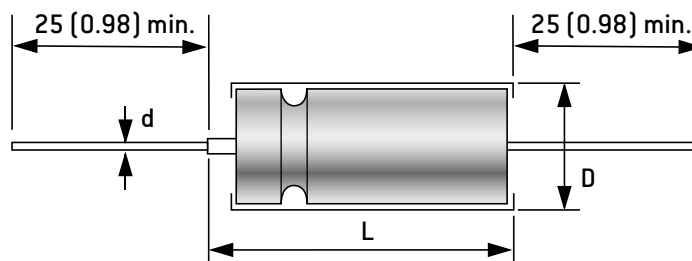

MARKING, PACKAGING, CONSTRUCTION:
 see general characteristics

HOW TO ORDER

Commercial description	Model	Case	Capacitance in µF	Tolerance in %	DC Voltage	Termination	
	ST79	D	150µF	20%	125V	H	
EXXELIA PN	Model code	Case	Capacitance code	Tolerance code	DC Voltage code	Termination	
	TS79ES	D	157	M	125	A	
			Expressed in pF with 3 digits: 2 digits for the value and the third for the multiplier	K = 10% M = 20%	Expressed in volt with 3 digits	Commercial description H = SnPb (non RoHS) - = Sn100% (RoHS)	EXXELIA PN A = SnPb (non RoHS) F = Sn100% (RoHS)

ST79

STANDARD RATINGS - ELECTRICAL CHARACTERISTICS

Capacitance 100Hz +20°C (μ F)	Case (code)	Type	Capacitance maximum change			Max. DF +20°C (%)	Max. Impedance 100Hz -55°C (Ω)	Max. I leak		I rms Max. 40kHz +85°C (mA)	Max. ESR	
			-55°C (%)	+85°C (%)	+125°C (%)			+20°C (μ A)	+85°C (μ A)		100Hz (Ω)	40kHz (Ω)
Rated voltage (+85°C) 25 V - Category voltage (+125°C) 15 V												
120	A	ST79	-42	+8	+12	14	25	1	5	1250	1,3	0,50
560	B	ST79	-65	+10	+15	42	12	2	10	2100	0,8	0,30
1200	C	ST79	-70	+12	+18	70	7	5	20	2600	0,6	0,23
1800	D	ST79	-75	+12	+20	81	6	4	25	3100	0,5	0,20
Rated voltage (+85°C) 30 V - Category voltage (+125°C) 20 V												
100	A	ST79	-38	+8	+12	11	25	1	5	1200	1,3	0,50
470	B	ST79	-65	+10	+18	36	15	2	10	1800	0,8	0,30
1000	C	ST79	-70	+10	+18	63	7	7	25	2500	0,7	0,25
1500	D	ST79	-60	+10	+20	81	5	5	30	3000	0,6	0,20
Rated voltage (+85°C) 40 V - Category voltage (+125°C) 25 V												
1000	D	ST79	-60	+10	+20	40	8	8	65	2750	0,7	0,25
Rated voltage (+85°C) 50 V - Category voltage (+125°C) 30 V												
68	A	ST79	-25	+8	+15	9	35	1	5	1050	1,5	0,60
220	B	ST79	-50	+8	+15	18	18	2	10	1800	0,9	0,40
470	C	ST79	-50	+8	+15	31	10	3	25	2100	0,7	0,30
680	D	ST79	-60	+10	+20	43	6	5	40	2750	0,6	0,20
750	D	ST79	-60	+10	+20	40	8	6	55	2750	0,7	0,27
Rated voltage (+85°C) 60 V - Category voltage (+125°C) 40 V												
47	A	ST79	-25	+8	+12	9	44	1	5	1050	2,0	0,80
150	B	ST79	-40	+8	+15	15	20	2	10	1650	1,1	0,40
390	C	ST79	-50	+8	+15	31	13	3	25	2100	0,9	0,40
560	D	ST79	-60	+8	+15	40	8	5	40	2750	0,8	0,30
700	D	ST79	-60	+8	+15	42	8	7	60	2750	0,7	0,27
Rated voltage (+85°C) 63 V - Category voltage (+125°C) 40 V												
500	D	ST79	-60	+8	+15	40	8	5	40	2750	0,8	0,30
Rated voltage (+85°C) 75 V - Category voltage (+125°C) 50 V												
33	A	ST79	-25	+5	+9	8	66	1	5	1050	2,5	1,00
110	B	ST79	-35	+6	+10	12	24	2	10	1650	1,3	0,50
330	C	ST79	-50	+6	+10	29	12	3	30	2100	1,0	0,40
470	D	ST79	-60	+6	+10	38	10	5	50	2750	0,9	0,30
Rated voltage (+85°C) 100 V - Category voltage (+125°C) 65 V												
15	A	ST79	-18	+3	+10	5	125	1	5	1050	3,5	1,40
68	B	ST79	-30	+4	+12	12	37	2	10	1650	2,1	0,80
150	C	ST79	-38	+6	+6	21	22	3	25	2100	1,6	0,70
220	D	ST79	-50	+6	+6	23	15	5	50	2750	1,2	0,40
Rated voltage (+85°C) 125 V - Category voltage (+125°C) 85 V												
10	A	ST79	-15	+3	+10	5	175	1	5	1050	5,5	2,10
47	B	ST79	-25	+5	+12	10	47	2	10	1650	2,3	0,90
100	C	ST79	-25	+5	+10	16	35	3	25	2100	1,8	0,80
150	D	ST79	-35	+6	+12	21	18	5	50	2750	1,6	0,60

ST79 SMD



Wet tantalum capacitors
Hermetically sealed tantalum cases
High capacitance
Very high ripple current
 SMD
 Polarized

ELECTRICAL AND CLIMATIC CHARACTERISTICS

	ST79 SMD
Detail specification	According to DSCC DWG No. 93026 According to ESCC 3003/006
Operating temperature	-55°C +125°C
Damp heat	56 days
Capacitance range	10µF ⇒ 1800µF
Tolerance	± 10% - ± 20%
Voltage range	25V ⇒ 125V
Max. capacitance change -55°C	see table
Max. capacitance change +85°C	see table
Max. capacitance change +125°C	see table
Maximum DF at +20°C	see table
Maximum DF at +85°C	= lim20°C
Maximum DF at +125°C	= lim20°C
Max. impedance (100Hz) at -55°C	see table
Max. leakage current at +20°C	see table
Max. leakage current at +85°C	see table
Max. leakage current at +125°C	= lim+85°C
Max. ESR at 100Hz +25°C	see table
Max. ESR at 40kHz +25°C	see table
Max. ripple current 40kHz +85°C	see table
Reverse voltage	No continuous Reverse voltage. Reverse voltage is acceptable under some conditions: $U_{REV} \leq 1,5 V$, $I \leq 0,05 A$ second and repetition rate < 10Hz
Max. surge voltage at +85°C	1,15 x U_R
Max. surge voltage at +125°C	1,15 x U_C

DIMENSIONS (mm)

Case code	Dimensions with insulating sleeve							
	B max	F max	H max	E ±0,4	C max	G max	X max	Ø max
A	13,5	4,0	4,8	3,8	7,5	2,0	2,8	5,8
B	18,5	4,0	5,9	5,3	9,5	2,0	2,8	7,4
C	21,5	4,0	7,5	8,4	12,5	2,0	2,8	10,1
D	29,5	4,0	7,5	8,4	12,5	2,0	2,8	10,1

MARKING, PACKAGING, CONSTRUCTION:
 see general characteristics

HOW TO ORDER

Commercial description	Model	Case	Capacitance in µF	Tolerance in %	DC Voltage	Termination
	ST79 SMD	D	150µF	20%	125V	H
EXXELIA PN	Model code	Case	Capacitance code	Tolerance code	DC Voltage code	Termination
	TS78ES	D	157	M	125	A

Expressed in pF with 3 digits: 2 digits for the value and the third for the multiplier

K = 10%
M = 20%

Expressed in volt with 3 digits

Commercial description
 H = SnPb (non RoHS)
 - = Sn100% (RoHS)

EXXELIA PN
 A = SnPb (non RoHS)
 F = Sn100% (RoHS)

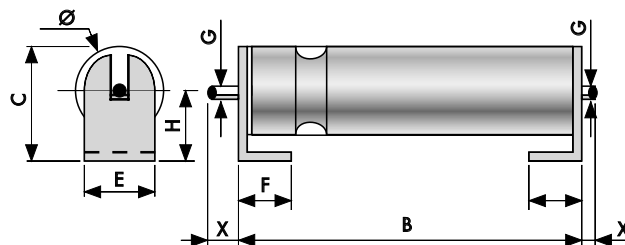

ST79 SMD

STANDARD RATINGS - ELECTRICAL CHARACTERISTICS

Capacitance 100Hz +20°C (μ F)	Case (code)	Type	Capacitance maximum change			Max. DF +20°C (%)	Max. Impedance 100Hz -55°C (Ω)	Max. I leak		Irms Max. 40kHz +85°C (mA)	Max. ESR	
			-55°C (%)	+85°C (%)	+125°C (%)			+20°C (μ A)	+85°C (μ A)		100Hz (Ω)	40kHz (Ω)
Rated voltage (+85°C) 25 V - Category voltage (+125°C) 15 V												
120	A	ST79 SMD	-42	+8	+12	14	25	1	5	1250	1,3	0,50
560	B	ST79 SMD	-65	+10	+15	42	12	2	10	2100	0,8	0,30
1200	C	ST79 SMD	-70	+12	+18	70	7	5	20	2600	0,6	0,23
1800	D	ST79 SMD	-75	+12	+20	81	6	4	25	3100	0,5	0,20
Rated voltage (+85°C) 30 V - Category voltage (+125°C) 20 V												
100	A	ST79 SMD	-38	+8	+12	11	25	1	5	1200	1,3	0,50
470	B	ST79 SMD	-65	+10	+18	36	15	2	10	1800	0,8	0,30
1000	C	ST79 SMD	-70	+10	+18	63	7	7	25	2500	0,7	0,25
1500	D	ST79 SMD	-60	+10	+20	81	5	5	30	3000	0,6	0,20
Rated voltage (+85°C) 40 V - Category voltage (+125°C) 25 V												
1000	D	ST79 SMD	-60	+10	+20	40	8	8	65	2750	0,7	0,25
Rated voltage (+85°C) 50 V - Category voltage (+125°C) 30 V												
68	A	ST79 SMD	-25	+8	+15	9	35	1	5	1050	1,5	0,60
220	B	ST79 SMD	-50	+8	+15	18	18	2	10	1800	0,9	0,40
470	C	ST79 SMD	-50	+8	+15	31	10	3	25	2100	0,7	0,30
680	D	ST79 SMD	-60	+10	+20	43	6	5	40	2750	0,6	0,20
750	D	ST79 SMD	-60	+10	+20	40	8	6	55	2750	0,7	0,27
Rated voltage (+85°C) 60 V - Category voltage (+125°C) 40 V												
47	A	ST79 SMD	-25	+8	+12	9	44	1	5	1050	2,0	0,80
150	B	ST79 SMD	-40	+8	+15	15	20	2	10	1650	1,1	0,40
390	C	ST79 SMD	-50	+8	+15	31	13	3	25	2100	0,9	0,40
560	D	ST79 SMD	-60	+8	+15	40	8	5	40	2750	0,8	0,30
700	D	ST79 SMD	-60	+8	+15	42	8	7	60	2750	0,7	0,27
Rated voltage (+85°C) 63 V - Category voltage (+125°C) 40 V												
500	D	ST79 SMD	-60	+8	+15	40	8	5	40	2750	0,8	0,30
Rated voltage (+85°C) 75 V - Category voltage (+125°C) 50 V												
33	A	ST79 SMD	-25	+5	+9	8	66	1	5	1050	2,5	1,00
110	B	ST79 SMD	-35	+6	+10	12	24	2	10	1650	1,3	0,50
330	C	ST79 SMD	-50	+6	+10	29	12	3	30	2100	1,0	0,40
470	D	ST79 SMD	-60	+6	+10	38	10	5	50	2750	0,9	0,30
Rated voltage (+85°C) 100 V - Category voltage (+125°C) 65 V												
15	A	ST79 SMD	-18	+3	+10	5	125	1	5	1050	3,5	1,40
68	B	ST79 SMD	-30	+4	+12	12	37	2	10	1650	2,1	0,80
150	C	ST79 SMD	-38	+6	+6	21	22	3	25	2100	1,6	0,70
220	D	ST79 SMD	-50	+6	+6	23	15	5	50	2750	1,2	0,40
Rated voltage (+85°C) 125 V - Category voltage (+125°C) 85 V												
10	A	ST79 SMD	-15	+3	+10	5	175	1	5	1050	5,5	2,10
47	B	ST79 SMD	-25	+5	+12	10	47	2	10	1650	2,3	0,90
100	C	ST79 SMD	-25	+5	+10	16	35	3	25	2100	1,8	0,80
150	D	ST79 SMD	-35	+6	+12	21	18	5	50	2750	1,6	0,60

ST79 HT200



Wet tantalum capacitors
Hermetically sealed tantalum cases
High temperature +200°C
High Capacitance
 Axial leads
 Polarized

ELECTRICAL AND CLIMATIC CHARACTERISTICS

ST79 HT200	
Detail specification	According to DSCC DWG No. 93026
Operating temperature	-55°C +200°C
Damp heat	56 days
Capacitance range	100µF ⇒ 1800µF
Tolerance	±10% - ±20%
Voltage range	25 V ⇒ 125 V
Max. capacitance change at -55°C	see table
Max. capacitance change at +85°C	see table
Max. capacitance change at +125°C	see table
Maximum DF at +20°C	see table
Maximum DF at +85°C	= lim20°C
Maximum DF at +125°C	= lim20°C
Max. impedance (100Hz) at -55°C	see table
Max. leakage current at +20°C	see table
Max. leakage current at +85°C	see table
Max. leakage current at +125°C	= lim85°C
Max. leakage current at +175°C	= 1,1 x lim85°C
Max. leakage current at +200°C	= 1,1 x lim85°C
Max. ESR at 100Hz +25°C / 40kHz +25°C	see table
Max. ripple current 40kHz +85°C	see table
Reverse voltage	No continuous Reverse voltage. Reverse voltage is acceptable under some conditions: $U_{REV} \leq 1,5 V$, $I_t \leq 0,05 A$ second and repetition rate < 10Hz
Max. surge voltage at +85°C	1,15 x U_R
Max. surge voltage at +125°C	1,15 x U_C

DIMENSIONS (mm)

Case code	Dimensions with insulating sleeve		
	L max	D max	d +10% -0,05
A	18	5,6	0,6
B	23	7,4	0,6
C	26	10,1	0,6
D	34	10,1	0,6

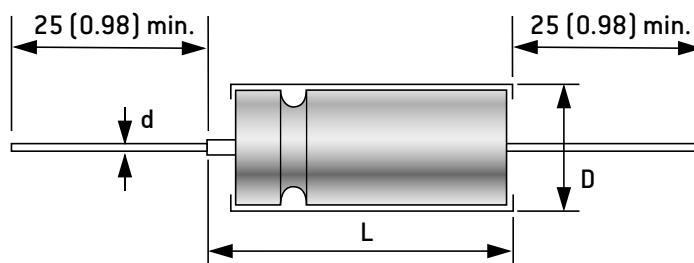

MARKING, PACKAGING, CONSTRUCTION:
 see general characteristics

HOW TO ORDER

Commercial description	Model	Case	Capacitance in µF	Tolerance in %	DC Voltage	Termination	
	ST79 HT200	D	1800µF	20%	25V	H	
EXXELIA PN	Model code	Case	Capacitance code	Tolerance code	DC Voltage code	Termination	
	TS79ESH	D	188	M	025	A	
			Expressed in pF with 3 digits: 2 digits for the value and the third for the multiplier	K = 10% M = 20%	Expressed in volt with 3 digits	Commercial description H = SnPb (non RoHS) - = Sn100% (RoHS)	EXXELIA PN A = SnPb (non RoHS) F = Sn100% (RoHS)

ST79 HT200

STANDARD RATINGS - ELECTRICAL CHARACTERISTICS

Capacitance 100Hz +20°C (μ F)	Case (code)	Type	Capacitance maximum change			Max. DF +20°C (%)	Max. Impedance 100Hz -55°C (Ω)	Max. I leak		Irms Max. 40kHz +85°C (mA)	Max. ESR	
			-55°C (%)	+85°C (%)	+125°C (%)			+20°C (μ A)	+85°C (μ A)		100Hz (Ω)	40kHz (Ω)
Rated voltage 25 V (+85°C) - 16 V (+125°C) - 15,5 V (+175°C) - 15 V (+200°C)												
120	A	ST79 HT200	-42	+8	+12	14	25,0	1	5	1250	1.30	0.50
560	B	ST79 HT200	-65	+10	+15	42	12,0	2	10	2100	0.80	0.30
1200	C	ST79 HT200	-70	+12	+18	70	7,00	5	20	2600	0.60	0.23
1800	D	ST79 HT200	-75	+12	+20	81	6,00	4	25	3100	0.50	0.20
Rated voltage 30 V (+85°C) - 20 V (+125°C) - 19 V (+175°C) - 18 V (+200°C)												
100	A	ST79 HT200	-38	+8	+12	11	25,0	1	5	1200	1.30	0.50
470	B	ST79 HT200	-65	+10	+18	36	15,0	2	10	1800	0.80	0.30
1000	C	ST79 HT200	-70	+10	+18	63	7,00	7	25	2500	0.70	0.25
1500	D	ST79 HT200	-60	+10	+20	81	5,00	5	30	3000	0.60	0.20
Rated voltage 40 V (+85°C) - 26 V (+125°C) - 25 V (+175°C) - 24 V (+200°C)												
1000	D	ST79 HT200	-60	+10	+20	40	8,00	8	65	2750	0.70	0.25
Rated voltage 50 V (+85°C) - 33 V (+125°C) - 32 V (+175°C) - 30 V (+200°C)												
68	A	ST79 HT200	-25	+8	+15	9	35,0	1	5	1050	1.50	0.60
220	B	ST79 HT200	-50	+8	+15	18	18,0	2	10	1800	0.90	0.40
470	C	ST79 HT200	-50	+8	+15	31	10,0	3	25	2100	0.70	0.30
680	D	ST79 HT200	-60	+10	+20	43	6,00	5	40	2750	0.60	0.20
750	D	ST79 HT200	-60	+10	+20	40	8,00	6	55	2750	0.70	0.27
Rated voltage 60 V (+85°C) - 40 V (+125°C) - 39 V (+175°C) - 36 V (+200°C)												
47	A	ST79 HT200	-25	+8	+12	9	44,0	1	5	1050	2.00	0.80
150	B	ST79 HT200	-40	+8	+15	15	20,0	2	10	1650	1.10	0.40
390	C	ST79 HT200	-50	+8	+15	31	13,0	3	25	2100	0.90	0.40
560	D	ST79 HT200	-60	+8	+15	40	8,00	5	40	2750	0.80	0.30
700	D	ST79 HT200	-60	+8	+15	42	8,00	7	60	2750	0.70	0.27
Rated voltage 63 V (+85°C) - 40 V (+125°C) - 39 V (+175°C) - 36 V (+200°C)												
500	D	ST79 HT200	-60	+8	+15	40	8,00	5	40	2750	0.80	0.30
Rated voltage 75 V (+85°C) - 50 V (+125°C) - 48 V (+175°C) - 45 V (+200°C)												
33	A	ST79 HT200	-25	+5	+9	8	66,0	1	5	1050	2.50	1.00
110	B	ST79 HT200	-25	+5	+9	10	25,0	2	10	1650	1.30	0.50
330	C	ST79 HT200	-50	+6	+10	29	12,0	3	30	2100	1.00	0.40
470	D	ST79 HT200	-60	+6	+10	38	10,0	5	50	2750	0.90	0.30
Rated voltage 100 V (+85°C) - 75 V (+125°C) - 63 V (+175°C) - 60 V (+200°C)												
15	A	ST79 HT200	-18	+3	+10	5	125,0	1	5	1050	3.50	1.40
68	B	ST79 HT200	-30	+4	+12	12	37,0	2	10	1650	2.10	0.80
150	C	ST79 HT200	-38	+6	+6	21	22,0	3	25	2100	1.60	0.70
220	D	ST79 HT200	-50	+6	+6	23	15,0	5	50	2750	1.20	0.40
Rated voltage 125 V (+85°C) - 85 V (+125°C) - 80 V (+175°C) - 75 V (+200°C)												
10	A	ST79 HT200	-15	+3	+10	5	175,0	1	5	1050	5.50	2.10
47	B	ST79 HT200	-25	+5	+12	10	47,0	2	10	1650	2.30	0.90
100	C	ST79 HT200	-25	+5	+10	16	35,0	3	25	2100	1.80	0.80
150	D	ST79 HT200	-35	+6	+12	21	18,0	5	50	2750	1.60	0.60

WT83



Wet tantalum capacitors
Hermetically sealed tantalum cases
Very high capacitance
Enhanced performances
 Axial leads
 Polarized

ELECTRICAL AND CLIMATIC CHARACTERISTICS

	WT83
Detail specification	According to DSCC DWG No. 10004
Operating temperature	-55°C +125°C
Damp heat	MIL-STD-202 method 103 (56 days)
Capacitance range	150µF ⇒ 10 000µF
Tolerance	± 10% - ± 20%
Voltage range	10V ⇒ 125V
Max. capacitance change at -55°C	see table
Max. capacitance change at +85°C	see table
Max. capacitance change at +125°C	see table
Max. Impedance [100Hz] at -55°C	see table
Max. leakage current at +20°C	see table
Max. leakage current at +85°C	see table
Max. leakage current at +125°C	= lim85°C
Max. ripple current 40kHz +85°C	see table
Max. ESR at 100Hz +25°C / 40kHz +25°C	see table
Reverse voltage	No
Max. surge voltage at +85°C	1,15 x U _R
Max. surge voltage at +125°C	1,15 x U _C
Life test	MIL-PRF-39006 (2000 h at 85°C under rated voltage or 2000 h at 125°C under category voltage)
Low pressure	MIL-STD-202 method 105C (1,45 mbar - 45 720 m)
Shock	MIL-STD-202 method 213 (100 g)
Vibrations, high frequency	MIL-STD-202 method 204 (50 g)
Thermal shock	MIL-STD-202 method 107 (-55°C +125°C 30 cycles)
Solderability	MIL-STD-202 method 208
Terminal strength	MIL-STD-202 method 211

DIMENSIONS (mm)

Case code	Dimensions with insulating sleeve		
	L max	D max	d +10% -0,05
C	26	10,1	0,6
D	34	10,1	0,6

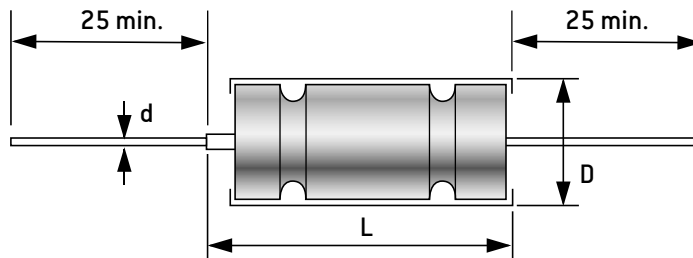

MARKING, PACKAGING, CONSTRUCTION:
 see general characteristics

HOW TO ORDER

Commercial description	Model	Case	Capacitance in µF	Tolerance in %	DC Voltage	Termination	Insulating sleeve		
	WT83	D	10000µF	20%	10V	H	-		
EXXELIA PN	Model code	Case	Capacitance code	Tolerance code	DC Voltage code	Termination	Insulating sleeve		
	WT83	D	109	M	010	H	S		
			Expressed in pF with 3 digits: 2 digits for the value and the third for the multiplier	K = 10% M = 20%	Expressed in volt with 3 digits	EXXELIA PN H = SnPb (non RoHS) F = Sn100% (RoHS)	Com. description H = SnPb - = Sn100%	Commercial description - = With WITHOUT SLEEVE = Without	EXXELIA PN S = With U = Without

WT83

STANDARD RATINGS - ELECTRICAL CHARACTERISTICS

Capacitance 100Hz +20°C (μ F)	Case (code)	Type	Capacitance maximum change			Max. Impedance 100Hz -55°C (Ω)	Max. I leak		I _{rms} Max. 40kHz +85°C (mA)	Max. ESR	
			-55°C (%)	+85°C (%)	+125°C (%)		+20°C (μ A)	+85°C / +125°C (μ A)		100Hz (Ω)	40kHz (Ω)
Rated voltage (+85°C) 10V - Category voltage (+125°C) 7V											
4700	C	WT83	-80	+10	+20	3.50	16	100	4000	0.35	0.14
10 000	D	WT83	-85	+20	+35	3.00	25	150	5000	0.25	0.10
Rated voltage (+85°C) 16V - Category voltage (+125°C) 11V											
3300	C	WT83	-80	+10	+15	3.50	16	100	4000	0.35	0.14
6000	D	WT83	-80	+15	+20	3.00	25	150	4500	0.30	0.12
Rated voltage (+85°C) 25V - Category voltage (+125°C) 15V											
2200	C	WT83	-80	+10	+15	5.50	16	100	3750	0.40	0.16
4000	D	WT83	-80	+15	+20	5.00	25	125	4250	0.35	0.14
Rated voltage (+85°C) 30V - Category voltage (+125°C) 20V											
1800	C	WT83	-80	+15	+20	4.50	16	100	2100	0.45	0.18
3300	D	WT83	-80	+20	+25	4.00	25	125	2750	0.35	0.14
Rated voltage (+85°C) 35V - Category voltage (+125°C) 22V											
1500	C	WT83	-80	+15	+25	5.00	16	100	3000	0.50	0.20
2800	D	WT83	-80	+20	+30	4.50	25	125	4000	0.35	0.14
Rated voltage (+85°C) 50V - Category voltage (+125°C) 30V											
1000	C	WT83	-70	+10	+20	10.0	16	125	2450	0.95	0.38
1500	C	WT83	-80	+15	+25	8.00	15	130	2400	1.00	0.40
1500	D	WT83	-70	+20	+20	6.00	25	110	3500	0.35	0.14
2200	D	WT83	-80	+25	+30	4.50	25	125	3000	0.60	0.24
Rated voltage (+85°C) 60V - Category voltage (+125°C) 40V											
600	C	WT83	-75	+12	+15	10.0	20	120	2500	0.90	0.36
1000	D	WT83	-40	+10	+15	5.50	20	120	3500	0.50	0.20
1200	D	WT83	-70	+15	+20	6.00	20	200	3500	0.50	0.20
Rated voltage (+85°C) 75V - Category voltage (+125°C) 50V											
470	C	WT83	-45	+10	+25	10.0	25	100	3000	0.60	0.24
750	D	WT83	-35	+10	+15	6.50	20	120	3500	0.50	0.20
1000	D	WT83	-65	+12	+20	8.00	20	200	3500	0.60	0.24
Rated voltage (+85°C) 100V - Category voltage (+125°C) 65V											
220	C	WT83	-55	+10	+15	18.0	5	25	2500	1.40	0.56
400	D	WT83	-40	+6	+12	15.0	10	120	3000	0.70	0.28
470	D	WT83	-50	+10	+20	10.0	25	250	3500	0.70	0.28
Rated voltage (+85°C) 125V - Category voltage (+125°C) 85V											
150	C	WT83	-50	+10	+15	25.0	5	25	2000	1.10	0.44
240	D	WT83	-35	+6	+12	20.0	15	150	2500	0.80	0.32
330	D	WT83	-55	+8	+12	15.0	25	250	2500	0.80	0.32

WS83



Wet tantalum capacitors
Hermetically sealed tantalum cases
Very high capacitance
Enhanced performances
SMD
 Polarized

ELECTRICAL AND CLIMATIC CHARACTERISTICS

WS83	
Detail specification	According to DSCC DWG No. 10004
Operating temperature	-55°C +125°C
Damp heat	MIL-STD-202 method 103 (56 days)
Capacitance range	150µF ⇒ 10 000µF
Tolerance	± 10% - ± 20%
Voltage range	10V ⇒ 125V
Max. capacitance change at -55°C	see table
Max. capacitance change at +85°C	see table
Max. capacitance change at +125°C	see table
Max. Impedance [100Hz] at -55°C	see table
Max. leakage current at +20°C	see table
Max. leakage current at +85°C	see table
Max. leakage current at +125°C	= lim85°C
Max. ripple current 40kHz +85°C	see table
Max. ESR at 100Hz +25°C / 40kHz +25°C	see table
Reverse voltage	No
Max. surge voltage at +85°C	1,15 x U _R
Max. surge voltage at +125°C	1,15 x U _C
Life test	MIL-PRF-39006 (2000 h at 85°C under rated voltage or 2000 h at 125°C under category voltage)
Low pressure	MIL-STD-202 method 105C (1,45 mbar - 45 720 m)
Shock	MIL-STD-202 method 213 (100 g)
Vibrations, high frequency	MIL-STD-202 method 204 (50 g)
Thermal shock	MIL-STD-202 method 107 (-55°C +125°C 30 cycles)

DIMENSIONS (mm)

Case code	Dimensions with insulating sleeve							
	B max	F max	H max	E ±0,4	C max	G max	X max	Ø max
C	21,5	4,0	7,5	8,4	12,5	2,0	2,8	10,1
D	29,5	4,0	7,5	8,4	12,5	2,0	2,8	10,1

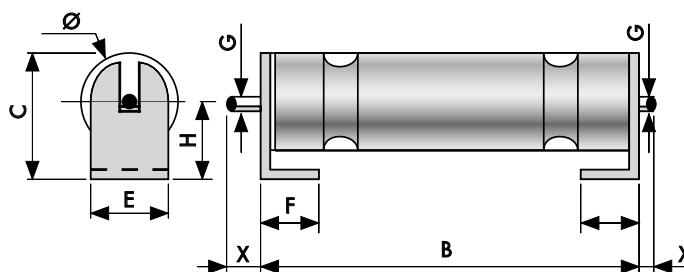

MARKING, PACKAGING, CONSTRUCTION:
 see general characteristics

HOW TO ORDER

Commercial description	Model	Case	Capacitance in µF	Tolerance in %	DC Voltage	Termination	Insulating sleeve
WS83 SMD	D	10000µF	20%	10V	H	-	
EXXELIA PN	Model code	Case	Capacitance code	Tolerance code	DC Voltage code	Termination	Insulating sleeve
WS83	D	109	M	010	H	S	
		Expressed in pF with 3 digits: 2 digits for the value and the third for the multiplier	K = 10% M = 20%	Expressed in volt with 3 digits	EXXELIA PN H = SnPb (non RoHS) F = Sn100% (RoHS)	Com. description H = SnPb - = Sn100%	Commercial description - = With WITHOUT SLEEVE = Without EXXELIA PN S = With U = Without

WS83

STANDARD RATINGS - ELECTRICAL CHARACTERISTICS

Capacitance 100Hz +20°C (μ F)	Case (code)	Type	Capacitance maximum change			Max. Impedance 100Hz -55°C (Ω)	Max. I leak		I _{rms} Max. 40kHz +85°C (mA)	Max. ESR	
			-55°C (%)	+85°C (%)	+125°C (%)		+20°C (μ A)	+85°C / +125°C (μ A)		100Hz (Ω)	40kHz (Ω)
Rated voltage (+85°C) 10V - Category voltage (+125°C) 7V											
4700	C	WS83	-80	+10	+20	3.50	16	100	4000	0.35	0.14
10 000	D	WS83	-85	+20	+35	3.00	25	150	5000	0.25	0.10
Rated voltage (+85°C) 16V - Category voltage (+125°C) 11V											
3300	C	WS83	-80	+10	+15	3.50	16	100	4000	0.35	0.14
6000	D	WS83	-80	+15	+20	3.00	25	150	4500	0.30	0.12
Rated voltage (+85°C) 25V - Category voltage (+125°C) 15V											
2200	C	WS83	-80	+10	+15	5.50	16	100	3750	0.40	0.16
4000	D	WS83	-80	+15	+20	5.00	25	125	4250	0.35	0.14
Rated voltage (+85°C) 30V - Category voltage (+125°C) 20V											
1800	C	WS83	-80	+15	+20	4.50	16	100	2100	0.45	0.18
3300	D	WS83	-80	+20	+25	4.00	25	125	2750	0.35	0.14
Rated voltage (+85°C) 35V - Category voltage (+125°C) 22V											
1500	C	WS83	-80	+15	+25	5.00	16	100	3000	0.50	0.20
2800	D	WS83	-80	+20	+30	4.50	25	125	4000	0.35	0.14
Rated voltage (+85°C) 50V - Category voltage (+125°C) 30V											
1000	C	WS83	-70	+10	+20	10.0	16	125	2450	0.95	0.38
1500	C	WS83	-80	+15	+25	8.00	15	130	2400	1.00	0.40
1500	D	WS83	-70	+20	+20	6.00	25	110	3500	0.35	0.14
2200	D	WS83	-80	+25	+30	4.50	25	125	3000	0.60	0.24
Rated voltage (+85°C) 60V - Category voltage (+125°C) 40V											
600	C	WS83	-75	+12	+15	10.0	20	120	2500	0.90	0.36
1000	D	WS83	-40	+10	+15	5.50	20	120	3500	0.50	0.20
1200	D	WS83	-70	+15	+20	6.00	20	200	3500	0.50	0.20
Rated voltage (+85°C) 75V - Category voltage (+125°C) 50V											
470	C	WS83	-45	+10	+25	10.0	25	100	3000	0.60	0.24
750	D	WS83	-35	+10	+15	6.50	20	120	3500	0.50	0.20
1000	D	WS83	-65	+12	+20	8.00	20	200	3500	0.60	0.24
Rated voltage (+85°C) 100V - Category voltage (+125°C) 65V											
220	C	WS83	-55	+10	+15	18.0	5	25	2500	1.40	0.56
400	D	WS83	-40	+6	+12	15.0	10	120	3000	0.70	0.28
470	D	WS83	-50	+10	+20	10.0	25	250	3500	0.70	0.28
Rated voltage (+85°C) 125V - Category voltage (+125°C) 85V											
150	C	WS83	-50	+10	+15	25.0	5	25	2000	1.10	0.44
240	D	WS83	-35	+6	+12	20.0	15	150	2500	0.80	0.32
330	D	WS83	-55	+8	+12	15.0	25	250	2500	0.80	0.32

DSCC 93026



Wet tantalum capacitors
Hermetically sealed tantalum cases
High capacitance
Very high ripple current
 Axial leads
 Polarized

ELECTRICAL AND CLIMATIC CHARACTERISTICS

	DSCC 93026
Detail specification	DWG NO. 93026
Operating temperature	-55°C +125°C
Capacitance range	10μF ⇒ 1800μF
Tolerance	± 10% - ± 20%
Voltage range	25V ⇒ 125V
Max. capacitance change -55°C	see table
Max. capacitance change +85°C	see table
Max. capacitance change +125°C	see table
Max. impedance at 120Hz -55°C	see table
Max. leakage current at +25°C	see table
Max. leakage current at +85°C / +125°C	see table
Max. ESR at 120Hz +25°C	see table
Max. ripple current 40kHz +85°C	see table
Reverse voltage	No continuous Reverse voltage. Reverse voltage is acceptable under some conditions: $U_{REV} \leq 1,5 \text{ V}$, $I \leq 0,05 \text{ A}$ second and repetition rate < 10Hz
Max. surge voltage at +85°C	1,15 x U_R

DIMENSIONS (mm)

Case (code)	Without insulating sleeve		With insulating sleeve	Lead length E ± 6,35
	D ± 0,41	L ^{+0,79} _{-0,41}	D max.	
T1	4,78	11,51	5,56	38,10
T2	7,14	16,28	7,92	57,15
T3	9,52	19,46	10,31	57,15
T4	9,52	26,97	10,31	57,15

PACKAGING, CONSTRUCTION:
see general characteristics

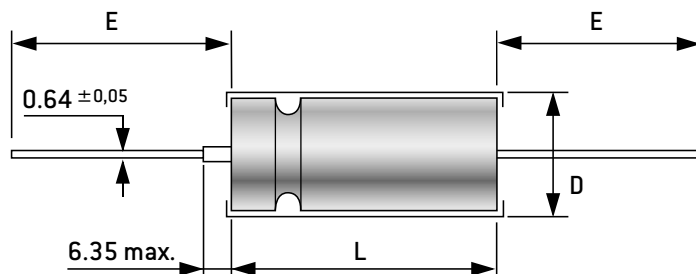

HOW TO ORDER

EXXELIA PN	Model code	Dash Number	Tolerance code	Insulating sleeve
	93026	-48	K	S
			K = ± 10%	U = Without
			M = ± 20%	S = With

DSCC 93026

STANDARD RATINGS - ELECTRICAL CHARACTERISTICS

Capacitance 120Hz +25°C (μ F)	Case (code)	Dash Number	Capacitance maximum change			Max. Impedance 120Hz -55°C (Ω)	Max. I leak		I rms Max. 40kHz +85°C (mA)	Max. ESR 120Hz +25°C (Ω)
			-55°C (%)	+85°C (%)	+125°C (%)		+25°C (μ A)	+85°C +125°C (μ A)		
Rated voltage (+85°C) 25 V - Derated voltage (+125°C) 15 V										
120	T1	29	-42	+8	+12	25	1	5	1250	1,3
560	T2	30	-65	+10	+15	12	2	10	2100	0,83
1200	T3	31	-70	+12	+18	7	5	20	2600	0,65
1800	T4	32	-75	+12	+20	7	6	25	3100	0,5
Rated voltage (+85°C) 30 V - Derated voltage (+125°C) 20 V										
100	T1	33	-38	+8	+12	25	1	5	1200	1,3
470	T2	34	-65	+10	+18	15	2	10	1800	0,85
1000	T3	35	-70	+10	+18	7	7	25	2500	0,7
1500	T4	36	-72	+10	+20	6	12	35	3000	0,6
Rated voltage (+85°C) 50 V - Derated voltage (+125°C) 30 V										
68	T1	37	-25	+8	+15	35	1	5	1050	1,5
220	T2	38	-50	+8	+15	17,5	2	10	1800	0,9
470	T3	39	-50	+8	+15	10	3	25	2100	0,75
680	T4	40	-58	+10	+20	8	5	40	2750	0,7
Rated voltage (+85°C) 60 V - Derated voltage (+125°C) 40 V										
47	T1	41	-25	+8	+12	44	1	5	1050	2,0
150	T2	42	-40	+8	+15	20	2	10	1650	1,1
390	T3	43	-60	+8	+15	15	3	25	2100	0,9
560	T4	44	-58	+8	+15	10	5	40	2750	0,8
Rated voltage (+85°C) 75 V - Derated voltage (+125°C) 50 V										
33	T1	45	-25	+5	+9	66	1	5	1050	2,5
110	T2	46	-35	+6	+10	24	2	10	1650	1,3
330	T3	47	-45	+6	+10	12	3	30	2100	1,0
470	T4	48	-55	+6	+10	12	5	50	2750	0,9
Rated voltage (+85°C) 100 V - Derated voltage (+125°C) 65 V										
15	T1	49	-18	+3	+10	125	1	5	1050	3,5
68	T2	50	-30	+4	+12	37	2	10	1650	2,1
150	T3	51	-35	+6	+12	22	3	25	2100	1,6
220	T4	52	-40	+6	+12	15	5	50	2750	1,2
Rated voltage (+85°C) 125 V - Derated voltage (+125°C) 85 V										
10	T1	53	-15	+3	+10	175	1	5	1050	5,5
47	T2	54	-25	+5	+12	47	2	10	1650	2,3
100	T3	55	-35	+5	+12	35	3	25	2100	1,8
150	T4	56	-35	+6	+12	20	5	50	2750	1,6

MIL 39006/22

MIL Qualified - CLR79



Wet tantalum capacitors
Hermetically sealed tantalum cases
High ripple current
 Axial leads
 Polarized

ELECTRICAL AND CLIMATIC CHARACTERISTICS

	MIL 39006/22
Detail specification	MIL-PRF-39006/22 Failure rate level M, level P, level R
Operating temperature	-55°C +125°C
Capacitance range	1,7µF ⇒ 1200µF
Tolerance	± 10% - ± 20%
Voltage range	6V ⇒ 125V
Max. capacitance change -55°C	see table
Max. capacitance change +85°C	see table
Max. capacitance change +125°C	see table
Maximum DF at +25°C	see table
Max. impedance at 120Hz -55°C	see table
Max. leakage current at +25°C	see table
Max. leakage current at +85°C / +125°C	see table
Max. ripple current at 40kHz +85°C	see table
Max. Reverse voltage at +85°C	3 volts
Max. Reverse voltage at +125°C	2 volts
Max. surge voltage at +85°C	1,15 x U _R

DIMENSIONS (mm)

Case code	Without insulating sleeve		With insulating sleeve	Lead length E ± 6,35
	D ± 0,41	L ^{+0,79} _{-0,41}	D max.	
T1	4,78	11,51	5,56	38,10
T2	7,14	16,28	7,92	57,15
T3	9,52	19,46	10,31	57,15
T4	9,52	26,97	10,31	57,15

PACKAGING, CONSTRUCTION:
 see general characteristics

HOW TO ORDER

EXXELIA PN	Model code	Dash Number	Vibration and shock (optional)
	M39006/22	-0220	H

- = Without
 H = With

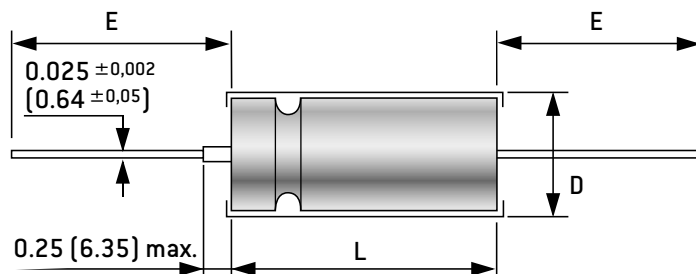

MIL Qualified - CLR79

MIL 39006/22

STANDARD RATINGS - ELECTRICAL CHARACTERISTICS

Capacitance 120Hz +25°C (μ F)	Case (code)	Dash Number Failure Rate Level M			Dash Number Failure Rate Level P			Dash Number Failure Rate Level R			Capacitance maximum change			Max. DF +25°C (%)	Max. Impe- dance 120Hz -55°C (Ω)	Max. I leak		Irms Max. 40kHz +85°C (mA)	Max. ESR 120Hz +25°C (Ω)
		$\pm 5\%$	$\pm 10\%$	$\pm 20\%$	$\pm 5\%$	$\pm 10\%$	$\pm 20\%$	$\pm 5\%$	$\pm 10\%$	$\pm 20\%$	-55°C	+85°C	+125°C			+25°C	+85°C +125°C		
											(%)	(%)	(%)			(μ A)	(μ A)		
Rated voltage (+85°C) 6 V - Derated voltage (+125°C) 4 V																			
30	T1	0003	0002	0001	0223	0222	0221	0443	0442	0441	-40	+10.5	+12	9	100	1	2	820	3.98
68	T1	0006	0005	0004	0226	0225	0224	0446	0445	0444	-40	+14	+16	15	60	1	2	960	3.16
140	T2	0009	0008	0007	0229	0228	0227	0449	0448	0447	-40	+14	+16	21	40	1	3	1200	1.99
270	T2	0012	0011	0010	0232	0231	0230	0452	0451	0450	-44	+17.5	+20	45	25	1	6.5	1375	2.21
330	T3	0015	0014	0013	0235	0234	0233	0455	0454	0453	-44	+14	+16	36	20	2	7.9	1800	1.45
560	T3	0018	0017	0016	0238	0237	0236	0458	0457	0456	-64	+17.5	+20	55	25	2	13	1900	1.30
1200	T4	-	0020	0019	-	0240	0239	-	0460	0459	-80	+25	+25	90	20	3	14	2265	1.00
Rated voltage (+85°C) 8 V - Derated voltage (+125°C) 5 V																			
25	T1	0023	0022	0021	0243	0242	0241	0463	0462	0461	-40	+10.5	+12	7.5	100	1	2	820	3.98
56	T1	0026	0025	0024	0246	0245	0244	0466	0465	0464	-40	+14	+16	14	59	1	2	900	3.32
120	T2	0029	0028	0027	0249	0248	0247	0469	0468	0467	-44	+17.5	+20	20	50	1	2	1220	2.21
220	T2	0032	0031	0030	0252	0251	0250	0472	0471	0470	-44	+17.5	+20	37	30	1	7	1370	2.23
290	T3	0035	0034	0033	0255	0254	0253	0475	0474	0473	-64	+17.5	+20	34	25	2	6	1770	1.56
430	T3	0038	0037	0036	0258	0257	0256	0478	0477	0476	-64	+17.5	+20	46	25	2	14	1825	1.42
850	T4	-	0040	0039	-	0260	0259	-	0480	0479	-80	+25	+25	60	22	4	16	2330	0.94
Rated voltage (+85°C) 10 V - Derated voltage (+125°C) 7 V																			
20	T1	0043	0042	0041	0263	0262	0261	0483	0482	0481	-32	+10.5	+12	6	175	1	2	820	3.98
47	T1	0046	0045	0044	0266	0265	0264	0486	0485	0484	-36	+14	+16	13	100	1	2	855	3.67
100	T2	0049	0048	0047	0269	0268	0267	0489	0488	0487	-36	+14	+16	15	60	1	4	1200	1.99
180	T2	0052	0051	0050	0272	0271	0270	0492	0491	0490	-36	+14	+16	30	40	1	7	1365	2.21
250	T3	0055	0054	0053	0275	0274	0273	0495	0494	0493	-40	+14	+16	30	30	2	10	1720	1.59
390	T3	0058	0057	0056	0278	0277	0276	0498	0497	0496	-64	+17.5	+20	44	25	2	16	1800	1.50
750	T4	-	0060	0059	-	0280	0279	-	0500	0499	-80	+25	+25	50	23	4	16	2360	0.88
Rated voltage (+85°C) 15 V - Derated voltage (+125°C) 10 V																			
15	T1	0063	0062	0061	0283	0282	0281	0503	0502	0501	-24	+10.5	+12	5	155	1	2	780	4.42
33	T1	0066	0065	0064	0286	0285	0284	0506	0505	0504	-28	+14	+16	10	90	1	2	820	4.02
70	T2	0069	0068	0067	0289	0288	0287	0509	0508	0507	-28	+14	+16	13	75	1	4	1150	2.46
120	T2	0072	0071	0070	0292	0291	0290	0512	0511	0510	-28	+17.5	+20	18	50	1	7	1450	1.99
170	T3	0075	0074	0073	0295	0294	0293	0515	0514	0513	-32	+14	+16	25	35	2	10	1480	1.95
270	T3	0078	0077	0076	0298	0297	0296	0518	0517	0516	-56	+17.5	+20	32	30	2	16	1740	1.57
540	T4	-	0080	0079	-	0300	0299	-	0520	0519	-80	+25	+25	40	23	6	24	2330	0.98
Rated voltage (+85°C) 25 V - Derated voltage (+125°C) 15 V																			
10	T1	0083	0082	0081	0303	0302	0301	0523	0522	0521	-16	+8	+9	4	220	1	2	715	5.31
22	T1	0086	0085	0084	0306	0305	0304	0526	0525	0524	-20	+10.5	+12	6.6	140	1	2	825	3.98
50	T2	0089	0088	0087	0309	0308	0307	0529	0528	0527	-28	+13	+15	11	70	1	2	1130	2.92
100	T2	0092	0091	0090	0312	0311	0310	0532	0531	0530	-28	+13	+15	15	50	1	10	1435	1.99
120	T3	0095	0094	0093	0315	0314	0313	0535	0534	0533	-32	+13	+15	21	38	2	6	1450	2.32
180	T3	0098	0097	0096	0318	0317	0316	0538	0537	0536	-48	+13	+15	26	32	2	18	1525	1.92
350	T4	-	0100	0099	-	0320	0319	-	0540	0539	-70	+25	+25	35	24	7	28	1970	1.33
Rated voltage (+85°C) 30 V - Derated voltage (+125°C) 20 V																			
8	T1	0103	0102	0101	0323	0322	0321	0543	0542	0541	-16	+8	+12	4	275	1	2	640	6.64
15	T1	0106	0105	0104	0326	0325	0324	0546	0545	0544	-20	+10.5	+12	5	175	1	2	780	4.42
40	T2	0109	0108	0107	0329	0328	0327	0549	0548	0547	-24	+10.5	+12	10	65	1	5	1120	3.32
68	T2	0112	0111	0110	0332	0331	0330	0552	0551	0550	-24	+13	+15	13	60	1	8	1285	2.54
100	T3	0115	0114	0113	0335	0334	0333	0555	0554	0553	-28	+10.5	+12	17	40	2	12	1450	2.26
150	T3	0118	0117	0116	0338	0337	0336	0558	0557	0556	-48	+13	+15	23	35	2	18	1525	2.03
300	T4	-	0120	0119	-	0340	0339	-	0560	0559	-60	+25	+25	31	25	8	32	1950	1.37

MIL 39006/22

MIL Qualified - CLR79

STANDARD RATINGS - ELECTRICAL CHARACTERISTICS

Capacitance 120Hz +25°C (μF)	Case (code)	Dash Number Failure Rate Level M			Dash Number Failure Rate Level P			Dash Number Failure Rate Level R			Capacitance maximum change			Max. DF +25°C (%)	Max. Impe- dance 120Hz -55°C (Ω)	Max. I leak		Irms Max. 40kHz +85°C (mA)	Max. ESR 120Hz +25°C (Ω)
		± 5%	± 10%	± 20%	± 5%	± 10%	± 20%	± 5%	± 10%	± 20%	-55°C (%)	+85°C (%)	+125°C (%)			+25°C (μA)	+85°C +125°C (μA)		
Rated voltage (+85°C) 50 V - Derated voltage (+125°C) 30 V																			
5	T1	0123	0122	0121	0343	0342	0341	0563	0562	0561	-16	+5	+6	3	400	1	2	580	7.96
10	T1	0126	0125	0124	0346	0345	0344	0566	0565	0564	-24	+8	+9	4	250	1	2	715	5.31
25	T2	0129	0128	0127	0349	0348	0347	0569	0568	0567	-20	+10.5	+12	8	95	1	5	1005	4.25
47	T2	0132	0131	0130	0352	0351	0350	0572	0571	0570	-28	+13	+15	11	70	1	9	1155	3.11
60	T3	0135	0134	0133	0355	0354	0353	0575	0574	0573	-16	+10.5	+12	12	45	2	12	1335	2.65
82	T3	0138	0137	0136	0358	0357	0356	0578	0577	0576	-32	+13	+15	15	45	2	16	1400	2.43
160	T4	-	0140	0139	-	0360	0359	-	0580	0579	-50	+25	+25	17	27	8	32	1900	1.41
Rated voltage (+85°C) 60 V - Derated voltage (+125°C) 40 V																			
4	T1	0143	0142	0141	0363	0362	0361	0583	0582	0581	-16	+5	+6	2.8	550	1	2	525	9.29
8.2	T1	0146	0145	0144	0366	0365	0364	0586	0585	0584	-24	+8	+9	4	275	1	2	625	6.47
20	T2	0149	0148	0147	0369	0368	0367	0589	0588	0587	-16	+10.5	+12	7	105	1	5	930	4.64
39	T2	0152	0151	0150	0372	0371	0370	0592	0591	0590	-28	+10.5	+12	10	90	1	9	1110	3.40
50	T3	0155	0154	0153	0375	0374	0373	0595	0594	0593	-16	+10.5	+12	10	50	2	12	1330	2.65
68	T3	0158	0157	0156	0378	0377	0376	0598	0597	0596	-32	+10.5	+12	13	50	2	16	1365	2.54
140	T4	-	0160	0159	-	0380	0379	-	0600	0599	-40	+20	+20	16	28	8	32	1850	1.52
Rated voltage (+85°C) 75 V - Derated voltage (+125°C) 50 V																			
3.5	T1	0163	0162	0161	0383	0382	0381	0603	0602	0601	-16	+5	+6	2.5	650	1	2	525	9.48
6.8	T1	0166	0165	0164	0386	0385	0384	0606	0605	0604	-20	+8	+9	3.5	300	1	2	610	6.83
15	T2	0169	0168	0167	0389	0388	0387	0609	0608	0607	-16	+8	+9	6	150	1	5	890	5.31
33	T2	0172	0171	0170	0392	0391	0390	0612	0611	0610	-24	+10.5	+15	10	90	1	10	1000	4.02
40	T3	0175	0174	0173	0395	0394	0393	0615	0614	0613	-16	+10.5	+12	9	60	2	12	1250	2.99
56	T3	0178	0177	0176	0398	0397	0396	0618	0617	0616	-28	+10.5	+15	11	60	2	17	1335	2.61
110	T4	-	0180	0179	-	0400	0399	-	0620	0619	-35	+20	+20	12	29	9	36	1850	1.45
Rated voltage (+85°C) 100 V - Derated voltage (+125°C) 65 V																			
2.5	T1	0183	0182	0181	0403	0402	0401	0623	0622	0621	-16	+7	+8	2	950	1	2	505	10.62
4.7	T1	0186	0185	0184	0406	0405	0404	0626	0625	0624	-16	+7	+8	3	500	1	2	565	8.47
11	T2	0189	0188	0187	0409	0408	0407	0629	0628	0627	-16	+8	+8	5	200	1	4	835	6.03
22	T2	0192	0191	0190	0412	0411	0410	0632	0631	0630	-16	+8	+8	7.5	100	1	9	965	4.52
30	T3	0195	0194	0193	0415	0414	0413	0635	0634	0633	-16	+8	+8	7	80	2	12	1240	3.10
43	T3	0198	0197	0196	0418	0417	0416	0638	0637	0636	-20	+8	+8	8.5	70	2	17	1335	2.62
86	T4	-	0200	0199	-	0420	0419	-	0640	0639	-25	+15	+15	10	30	9	36	1800	1.54
Rated voltage (+85°C) 125 V - Derated voltage (+125°C) 85 V																			
1.7	T1	0203	0202	0201	0423	0422	0421	0643	0642	0641	-16	+7	+8	2	1250	1	2	415	15.61
3.6	T1	0206	0205	0204	0426	0425	0424	0646	0645	0644	-16	+7	+8	2.7	600	1	2	520	9.95
9	T2	0209	0208	0207	0429	0428	0427	0649	0648	0647	-16	+7	+8	5	240	1	5	755	7.37
14	T2	0212	0211	0210	0432	0431	0430	0652	0651	0650	-16	+7	+8	6	167	1	7	860	5.69
18	T3	0215	0214	0213	0435	0434	0433	0655	0654	0653	-16	+7	+8	5	129	2	9	1130	3.69
25	T3	0218	0217	0216	0438	0437	0436	0658	0657	0656	-16	+7	+8	6	93	2	13	1200	3.18
56	T4	-	0220	0219	-	0440	0439	-	0660	0659	-25	+15	+15	6.5	32	10	40	1800	1.54

MIL Qualified - CLR81

MIL 39006/25



Wet tantalum capacitors
Hermetically sealed tantalum cases
High Capacitance
High ripple current
 Axial leads
 Polarized

ELECTRICAL AND CLIMATIC CHARACTERISTICS

	MIL 39006/25
Detail specification	MIL-PRF-39006/25 Failure rate level M, level P, level R
Operating temperature	-55°C +125°C
Capacitance range	6,8μF ⇔ 680μF
Tolerance	± 10% - ± 20%
Voltage range	25V ⇔ 125V
Max. capacitance change -55°C	see table
Max. capacitance change +85°C	see table
Max. capacitance change +125°C	see table
Maximum DF at +25°C	see table
Max. impedance at 120Hz -55°C	see table
Max. leakage current at +25°C	see table
Max. leakage current at +85°C / +125°C	see table
Max. ripple current 40kHz +85°C	see table
Max. Reverse voltage at +85°C	3 volts
Max. Reverse voltage at +125°C	2 volts
Max. surge voltage at +85°C	1,15 x U _R

DIMENSIONS (mm)

Case code	Without insulating sleeve		With insulating sleeve	Lead length E ± 6,35
	D ± 0,41	L ^{+0,79} _{-0,41}	D max.	
T1	4,78	11,51	5,56	38,10
T2	7,14	16,28	7,92	57,15
T3	9,52	19,46	10,31	57,15
T4	9,52	26,97	10,31	57,15

PACKAGING, CONSTRUCTION:
 see general characteristics

HOW TO ORDER

EXXELIA PN	Model code	Dash Number	Vibration and shock (optional)
	M39006/25	-0220	H
			- = Without H = With

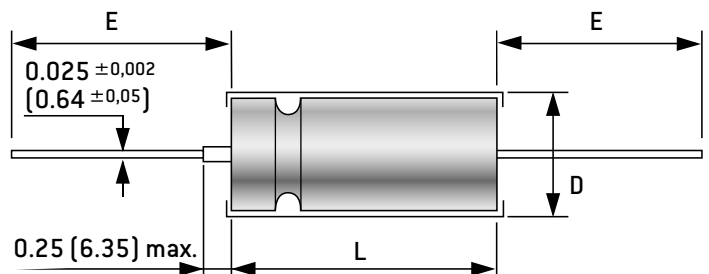

MIL 39006/25

MIL Qualified - CLR81

STANDARD RATINGS - ELECTRICAL CHARACTERISTICS

Capacitance 120Hz +25°C (μ F)	Case (code)	Dash Number Failure Rate Level M		Dash Number Failure Rate Level P		Dash Number Failure Rate Level R		Capacitance maximum change			Max. DF +25°C (%)	Max. Impedance 120Hz -55°C (Ω)	Max. I leak		Irms Max. 40kHz +85°C (mA)	Max. ESR 120Hz +25°C (Ω)
		$\pm 10\%$	$\pm 20\%$	$\pm 10\%$	$\pm 20\%$	$\pm 10\%$	$\pm 20\%$	-55°C (%)	+85°C (%)	+125°C (%)			+25°C (μ A)	+85°C +125°C (μ A)		
Rated voltage (+85°C) 25 V - Derated voltage (+125°C) 15 V																
68	T1	0034	0033	0122	0121	0210	0209	-40	+12	+15	22	90	2	9	850	4.29
270	T2	0036	0035	0124	0123	0212	0211	-62	+13	+16	55	33	3	16	1400	2.70
560	T3	0038	0037	0126	0125	0214	0213	-72	+20	+25	76	24	7	28	1750	1.80
Rated voltage (+85°C) 30 V - Derated voltage (+125°C) 20 V																
56	T1	0042	0041	0130	0129	0218	0217	-38	+12	+15	22	100	2	9	800	5.21
220	T2	0044	0043	0132	0131	0220	0219	-60	+13	+16	42	36	3	16	1200	2.53
470	T3	0046	0045	0134	0133	0222	0221	-65	+20	+25	64	25	8	32	1500	1.81
Rated voltage (+85°C) 50 V - Derated voltage (+125°C) 30 V																
33	T1	0050	0049	0138	0137	0226	0225	-29	+10	+12	12.3	135	2	9	700	4.95
120	T2	0052	0051	0140	0139	0228	0227	-42	+12	+15	22.5	49	4	24	1200	2.49
270	T3	0054	0053	0142	0141	0230	0229	-46	+20	+25	37	29	8	32	1450	1.82
Rated voltage (+85°C) 60 V - Derated voltage (+125°C) 40 V																
27	T1	0058	0057	0146	0145	0234	0233	-24	+10	+12	10.2	144	3	12	700	5.01
100	T2	0060	0059	0148	0147	0236	0235	-36	+12	+15	19	54	4	20	1100	2.52
220	T3	0062	0061	0150	0149	0238	0237	-40	+16	+20	30	29	8	32	1400	1.81
Rated voltage (+85°C) 75 V - Derated voltage (+125°C) 50 V																
22	T1	0066	0065	0154	0153	0242	0241	-19	+10	+12	8.5	157	3	12	600	5.13
82	T2	0068	0067	0156	0155	0244	0243	-30	+12	+15	15.2	63	4	24	1000	2.46
180	T3	0070	0069	0158	0157	0246	0245	-35	+16	+20	24.4	30	9	36	1300	2.23
Rated voltage (+85°C) 100 V - Derated voltage (+125°C) 65 V																
10	T1	0074	0073	0162	0161	0250	0249	-17	+10	+12	4.5	200	3	12	800	5.97
39	T2	0076	0075	0164	0163	0252	0251	-20	+12	+15	10.4	80	5	24	1300	3.54
68	T3	0078	0077	0166	0165	0254	0253	-30	+14	+16	11.3	40	10	40	1600	2.21
Rated voltage (+85°C) 125 V - Derated voltage (+125°C) 85 V																
6.8	T1	0082	0081	0170	0169	0258	0257	-14	+10	+12	6	300	3	12	700	11.71
27	T2	0084	0083	0172	0171	0260	0259	-18	+12	+15	7.2	90	5	24	1200	3.54
47	T3	0086	0085	0174	0173	0262	0261	-26	+14	+16	7.9	50	10	40	1500	2.23

CT9 CT9E

Wet tantalum capacitors
Hermetically sealed silver cases
Axial leads
Polarized



ELECTRICAL AND CLIMATIC CHARACTERISTICS

	CT9	CT9E
Detail specification	CECC 30202-004	CECC 30202-004
Operating temperature	-55°C +125°C	-55°C +125°C
Damp heat	56 days	56 days
Capacitance range	3,0μF ⇒ 1200μF	4,7μF ⇒ 2200μF
Tolerance	±10% - ±20%	±10% - ±20%
Voltage range	6,3V ⇒ 150V	6,3V ⇒ 125V
Max. capacitance change -55°C	see table	see table
Max. capacitance change +85°C	see table	see table
Max. capacitance change +125°C	see table	see table
Maximum DF at +20°C	see table	see table
Maximum DF at +85°C	= lim20°C	= lim20°C
Maximum DF at +125°C	= lim20°C	= lim20°C
Max. impedance (100Hz) at -55°C	see table	see table
Max. leakage current at +20°C	see table	see table
Max. leakage current at +85°C	see table	see table
Max. leakage current at +125°C	= lim+85°C	= lim+85°C
Max. ripple current 100kHz +85°C	see table	see table
Reverse voltage	No	No
Max. surge voltage at +85°C	1,15 x U _R	1,15 x U _R
Max. surge voltage at +125°C	1,15 x U _C	1,15 x U _C

DIMENSIONS (mm)

Case code	Dimensions with insulating sleeve		
	L max	D max	d +10% -0,05
A	18	5,8	0,6
B	23	7,4	0,6
C	26	10,1	0,6
D	34	10,1	0,6

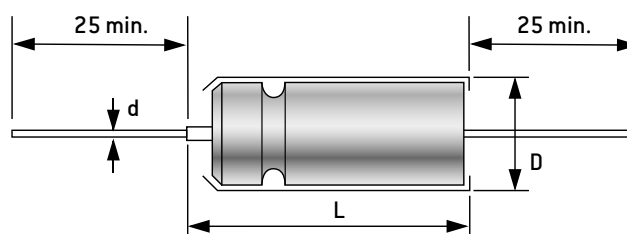

MARKING, PACKAGING, CONSTRUCTION:
see general characteristics

HOW TO ORDER

Commercial description	Model		Case	Capacitance in μF	Tolerance in %	DC Voltage	Termination
		CT9	CT9E	D	220μF	20%	40V
EXXELIA PN	Model code		Case	Capacitance code	Tolerance code	DC Voltage code	Termination
	TS09	TS09E	D	227	M	040	A
				Expressed in pF with 3 digits: 2 digits for the value and the third for the multiplier	K = 10% M = 20%	Expressed in volt with 3 digits	Commercial description H = SnPb (non RoHS) - = Sn100% (RoHS)
						EXXELIA PN A = SnPb (non RoHS) F = Sn100% (RoHS)	

CT9 CR

CT9E CR



Wet tantalum capacitors
Hermetically sealed silver cases
 Axial leads
 Polarized

ELECTRICAL AND CLIMATIC CHARACTERISTICS

Short case [similar to CT4]	CT9 CR	CT9E CR
Detail specification	According to CECC 30202-004	According to CECC 30202-004
Operating temperature	-55°C +125°C	-55°C +125°C
Damp heat	56 days	56 days
Capacitance range	3,0μF ⇔ 1200μF	4,7μF ⇔ 2200μF
Tolerance	±10% - ±20%	±10% - ±20%
Voltage range	6,3V ⇔ 150V	6,3V ⇔ 125V
Max. capacitance change -55°C	see table	see table
Max. capacitance change +85°C	see table	see table
Max. capacitance change +125°C	see table	see table
Maximum DF at +20°C	see table	see table
Maximum DF at +85°C	= lim20°C	= lim20°C
Maximum DF at +125°C	= lim20°C	= lim20°C
Max. impedance (100Hz) at -55°C	see table	see table
Max. leakage current at +20°C	see table	see table
Max. leakage current at +85°C	see table	see table
Max. leakage current at +125°C	= lim+85°C	= lim+85°C
Max. ripple current 100kHz +85°C	see table	see table
Reverse voltage	No	No
Max. surge voltage at +85°C	1,15 x U _R	1,15 x U _R
Max. surge voltage at +125°C	1,15 x U _C	1,15 x U _C

DIMENSIONS (mm)

Case code	Dimensions with insulating sleeve			
	L max	l max	D max	d +10% -0,05
A	17	14	5,8	0,6
B	21	17	7,4	0,6
C	25	21	10,1	0,6
D	32	28	10,1	0,6

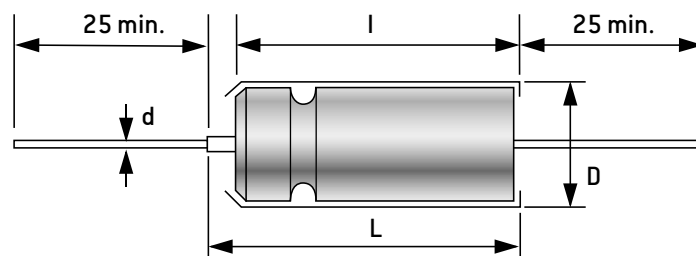

MARKING, PACKAGING, CONSTRUCTION:
 see general characteristics

HOW TO ORDER

Commercial description	Model		Case	Capacitance in μF	Tolerance in %	DC Voltage	Termination
		CT9 CR	CT9E CR	D	220μF	20%	40V
EXXELIA PN	Model code		Case	Capacitance code	Tolerance code	DC Voltage code	Termination
	TS09T	TS09ET	D	227	M	040	A
				Expressed in pF with 3 digits: 2 digits for the value and the third for the multiplier	K = 10% M = 20%	Expressed in volt with 3 digits	Commercial description H = SnPb (non RoHS) - = Sn100% (RoHS)
						EXXELIA PN A = SnPb (non RoHS) F = Sn100% (RoHS)	

(Standard range)

CT9
CT9 CR

STANDARD RATINGS - ELECTRICAL CHARACTERISTICS

Capacitance 100Hz +20°C (μF)	Case (code)	Type		Capacitance maximum change			Max. DF +20°C (%)	Max. Impedance 100Hz -55°C (Ω)	Max. I leak		I _{rms} Max. 100kHz +85°C (mA)
				-55°C (%)	+85°C (%)	+125°C (%)			+20°C (μA)	+85°C (μA)	
Rated voltage [+85°C] 6,3 V - Category voltage [+125°C] 4 V											
68	A	CT9	CT9 CR	-44	+14	+16	20	72	1	2	80
270	B	CT9	CT9 CR	-54	+17,5	+20	50	30	1	7	250
560	C	CT9	CT9 CR	-64	+17,5	+20	60	30	2	16	500
1200	D	CT9	CT9 CR	-80	+25	+25	100	24	4	16	800
Rated voltage [+85°C] 8 V - Category voltage [+125°C] 5 V											
56*	A	CT9	CT9 CR	-40	+14	+16	28	59	1	2	160
220*	B	CT9	CT9 CR	-44	+17,5	+20	59	30	1	7	270
430*	C	CT9	CT9 CR	-64	+17,5	+20	116	25	1	14	410
850*	D	CT9	CT9 CR	-80	+25	+25	115	22	1,5	16	670
Rated voltage [+85°C] 10 V - Category voltage [+125°C] 6,3 V											
47	A	CT9	CT9 CR	-36	+14	+16	18	120	1	2	80
150*	B	CT9	CT9 CR	-36	+14	+16	50	52	1	6	250
180	B	CT9	CT9 CR	-36	+14	+16	54	48	1	7	250
330*	C	CT9	CT9 CR	-64	+17,5	+20	74	35	2	16	410
390	C	CT9	CT9 CR	-64	+17,5	+20	88	30	2	16	500
680*	D	CT9	CT9 CR	-80	+25	+25	43	32	4	16	670
820	D	CT9	CT9 CR	-80	+25	+25	62	28	4	16	850
Rated voltage [+85°C] 16 V - Category voltage [+125°C] 10 V											
33	A	CT9	CT9 CR	-28	+14	+16	12	108	1	2	80
120	B	CT9	CT9 CR	-28	+17,5	+20	36	60	1	7	250
220*	C	CT9	CT9 CR	-56	+17,5	+20	55	40	2	16	410
270	C	CT9	CT9 CR	-56	+17,5	+20	61	36	2	16	500
560	D	CT9	CT9 CR	-80	+25	+25	51	28	6	24	850
Rated voltage [+85°C] 25 V - Category voltage [+125°C] 40 V											
22	A	CT9	CT9 CR	-20	+10,5	+12	8	168	1	2	80
100	B	CT9	CT9 CR	-28	+13	+15	30	60	1	10	250
120*	C	CT9	CT9 CR	-38	+13	+15	32	42	2	12	410
180	C	CT9	CT9 CR	-48	+13	+15	54	38	2	18	500
390	D	CT9	CT9 CR	-70	+25	+25	33	29	7	28	850
Rated voltage [+85°C] 30 V - Category voltage [+125°C] 20 V											
8*	A	CT9	CT9 CR	-16	+8	+12	6	275	1	2	80
15*	A	CT9	CT9 CR	-20	+10,5	+12	8	175	1	2	80
68*	B	CT9	CT9 CR	-28	+13	+15	26	65	1	8	250
150*	C	CT9	CT9 CR	-48	+13	+15	28	40	2	18	500
270*	D	CT9	CT9 CR	-60	+25	+25	30	30	8	32	800
Rated voltage [+85°C] 40 V - Category voltage [+125°C] 25 V											
12	A	CT9	CT9 CR	-24	+8	+10	8	300	1	2	60
56	B	CT9	CT9 CR	-28	+13	+15	25	84	1	9	250
100	C	CT9	CT9 CR	-40	+13	+15	19	54	2	17	500
120*	D	CT9	CT9 CR	-50	+20	+20	23	60	9	36	550
220	D	CT9	CT9 CR	-55	+25	+25	29	32	8	32	780
Rated voltage [+85°C] 50 V - Category voltage [+125°C] 32 V											
10*	A	CT9	CT9 CR	-24	+8	+9	6	300	1	2	80
47*	B	CT9	CT9 CR	-28	+13	+15	21	90	1	9	250
82*	C	CT9	CT9 CR	-32	+12	+12	26	55	2	16	500
180*	D	CT9	CT9 CR	-50	+20	+20	15	27	7	12	750
Rated voltage [+85°C] 60 V - 63 V - Category voltage [+125°C] 40 V											
8,2	A	CT9	CT9 CR	-24	+8	+9	5	330	1	2	60
20*	B	CT9	CT9 CR	-28	+10,5	+12	11	125	1	5	230
27*	B	CT9	CT9 CR	-28	+10,5	+12	15	110	1	7	230
39	B	CT9	CT9 CR	-28	+10,5	+12	20	108	1	9	250
68	C	CT9	CT9 CR	-32	+10,5	+12	31	60	2	16	500
150	D	CT9	CT9 CR	-40	+20	+20	28	34	8	32	750

* out of CECC range

CT9 CT9 CR

(Standard range)

STANDARD RATINGS - ELECTRICAL CHARACTERISTICS

Capacitance 100Hz +20°C (μ F)	Case (code)	Type		Capacitance maximum change			Max. DF +20°C (%)	Max. Impedance 100Hz -55°C (Ω)	Max. I leak		I _{rms} Max. 100kHz +85°C (mA)
				-55°C (%)	+85°C (%)	+125°C (%)			+20°C (μ A)	+85°C (μ A)	
Rated voltage [+85°C] 75 V - Category voltage [+125°C] 50 V											
3,5*	A	CT9	CT9 CR	-16	+5	+6	4	650	1	2	60
6,8	A	CT9	CT9 CR	-20	+8	+9	4	360	1	2	60
33	B	CT9	CT9 CR	-24	+10,5	+15	15	108	1	10	250
56	C	CT9	CT9 CR	-28	+10,5	+15	25	72	2	17	500
100	D	CT9	CT9 CR	-35	+20	+20	24	36	9	36	750
Rated voltage [+85°C] 100 V - Category voltage [+125°C] 63 V											
4,7	A	CT9	CT9 CR	-16	+7	+8	3,5	600	1	2	60
10*	B	CT9	CT9 CR	-17	+10	+12	8	250	1	12	230
12*	B	CT9	CT9 CR	-17	+10	+12	10	220	1	12	230
22	B	CT9	CT9 CR	-16	+7	+8	11,5	120	1	9	250
30*	C	CT9	CT9 CR	-16	+7	+8	16	90	2	15	340
39*	C	CT9	CT9 CR	-20	+7	+8	18	87	2	17	340
43*	C	CT9	CT9 CR	-20	+7	+8	20	85	2	17	340
47	C	CT9	CT9 CR	-20	+7	+8	21	84	2	17	500
82	D	CT9	CT9 CR	-25	+15	+15	20	50	9	36	750
Rated voltage [+85°C] 125 V - Category voltage [+125°C] 80 V											
3,3*	A	CT9	CT9 CR	-10	+7	+8	4	750	1	2	50
3,9	A	CT9	CT9 CR	-16	+7	+8	4	720	1	2	50
14*	B	CT9	CT9 CR	-16	+7	+8	14	210	1	7	210
15	B	CT9	CT9 CR	-16	+7	+8	13,5	200	1	7	250
27	C	CT9	CT9 CR	-16	+7	+8	20	112	2	13	500
56	D	CT9	CT9 CR	-25	+15	+15	17	60	10	40	750
Rated voltage [+85°C] 150 V - Category voltage [+125°C] 100 V											
3,0*	A	CT9	CT9 CR	-16	+7	+8	16	710	1	3	110
11*	B	CT9	CT9 CR	-16	+7	+8	16	200	2	12	190
14*	C	CT9	CT9 CR	-16	+7	+8	20	175	4	24	260
22*	C	CT9	CT9 CR	-16	+7	+8	20	110	4	24	260

* out of CECC range

[Extended range]

CT9E
CT9E CR

STANDARD RATINGS - ELECTRICAL CHARACTERISTICS

Capacitance 100Hz +20°C (μ F)	Case (code)	Type		Capacitance maximum change			Max. DF +20°C (%)	Max. Impedance 100Hz -55°C (Ω)	Max. I leak		I _{rms} Max. 100kHz +85°C (mA)
				-55°C (%)	+85°C (%)	+125°C (%)			+20°C (μ A)	+85°C (μ A)	
Rated voltage (+85°C) 6,3 V - Category voltage (+125°C) 4 V											
180	A	CT9E	CT9E CR	-60	+13	+16	30	55	1	10	90
220*	A	CT9E	CT9E CR	-65	+16	+16	40	22	2	9	90
680*	B	CT9E	CT9E CR	-80	+20	+20	55	20	3	14	280
820	B	CT9E	CT9E CR	-88	+16	+20	115	22	2	17	280
1500	C	CT9E	CT9E CR	-90	+20	+25	115	22	6	25	540
1800*	D	CT9E	CT9E CR	-80	+20	+25	72	16	7	25	800
2200	D	CT9E	CT9E CR	-90	+25	+30	125	16	6	25	800
Rated voltage (+85°C) 10 V - Category voltage (+125°C) 6,3 V											
120*	A	CT9E	CT9E CR	-50	+16	+16	32	50	2	9	80
150	A	CT9E	CT9E CR	-55	+13	+16	25	65	1	10	90
470*	B	CT9E	CT9E CR	-70	+20	+20	35	21	3	16	280
560	B	CT9E	CT9E CR	-77	+16	+20	80	34	2	17	280
1000*	C	CT9E	CT9E CR	-75	+20	+25	67	12	5	20	540
1200	C	CT9E	CT9E CR	-88	+20	+25	95	22	3	25	540
1500	D	CT9E	CT9E CR	-88	+25	+30	85	18	6	25	800
Rated voltage (+85°C) 16 V - Category voltage (+125°C) 10 V											
100	A	CT9E	CT9E CR	-44	+13	+16	25	88	1	10	80
390	B	CT9E	CT9E CR	-66	+16	+20	55	38	2	17	280
680*	C	CT9E	CT9E CR	-70	+15	+20	50	13	5	20	510
820	C	CT9E	CT9E CR	-77	+20	+25	85	27	4	25	510
1000	D	CT9E	CT9E CR	-80	+30	+30	60	21	6	35	750
1200*	D	CT9E	CT9E CR	-70	+25	+25	55	17	8	28	750
Rated voltage (+85°C) 20 V - Category voltage (+125°C) 13 V											
82*	A	CT9E	CT9E CR	-40	+16	+16	25	50	2	9	70
330*	B	CT9E	CT9E CR	-60	+20	+20	30	21	3	16	280
1000*	D	CT9E	CT9E CR	-70	+25	+25	40	21	8	28	750
Rated voltage (+85°C) 25 V - Category voltage (+125°C) 16 V											
68	A	CT9E	CT9E CR	-40	+12	+15	17	110	1	10	80
270	B	CT9E	CT9E CR	-62	+13	+16	38	40	2	17	280
470*	C	CT9E	CT9E CR	-60	+15	+20	33	18	6	24	510
560	C	CT9E	CT9E CR	-72	+20	+25	58	25	5	35	510
680	D	CT9E	CT9E CR	-80	+25	+30	38	24	6	35	750
820*	D	CT9E	CT9E CR	-60	+25	+25	40	17	9	30	750
Rated voltage (+85°C) 30 V - Category voltage (+125°C) 20 V											
56*	A	CT9E	CT9E CR	-32	+16	+16	20	55	2	9	70
180*	B	CT9E	CT9E CR	-40	+16	+16	21	27	3	16	280
220*	B	CT9E	CT9E CR	-40	+16	+16	23	25	3	16	280
390*	C	CT9E	CT9E CR	-55	+20	+25	27	15	6	24	510
680*	D	CT9E	CT9E CR	-60	+25	+25	36	20	7	25	750
Rated voltage (+85°C) 40 V - Category voltage (+125°C) 25 V											
39	A	CT9E	CT9E CR	-35	+10	+12	12	140	2	10	70
47*	A	CT9E	CT9E CR	-45	+16	+20	16	60	2	9	70
150	B	CT9E	CT9E CR	-52	+13	+16	22	50	4	35	270
330	C	CT9E	CT9E CR	-60	+20	+25	22	30	6	40	500
470	D	CT9E	CT9E CR	-70	+25	+30	35	28	6	40	750
560*	D	CT9E	CT9E CR	-55	+25	+25	26	29	8	28	750
Rated voltage (+85°C) 50 V - Category voltage (+125°C) 32 V											
33*	A	CT9E	CT9E CR	-24	+12	+12	16	120	2	9	70
120*	B	CT9E	CT9E CR	-35	+15	+15	18	26	3	18	280
160*	C	CT9E	CT9E CR	-35	+20	+25	22	32	3	32	420
270*	C	CT9E	CT9E CR	-40	+20	+25	30	24	7	28	500
390*	D	CT9E	CT9E CR	-45	+20	+25	25	20	8	32	750

* out of CECC range

CT9E CT9E CR

(Extended range)

STANDARD RATINGS - ELECTRICAL CHARACTERISTICS

Capacitance 100Hz +20°C (μ F)	Case (code)	Type		Capacitance maximum change			Max. DF +20°C (%)	Max. Impedance 100Hz -55°C (Ω)	Max. I leak		I _{rms} Max. 100kHz +85°C (mA)
				-55°C (%)	+85°C (%)	+125°C (%)			+20°C (μ A)	+85°C (μ A)	
Rated voltage (+85°C) 60 V - 63 V - Category voltage (+125°C) 40 V											
27	A	CT9E	CT9E CR	-24	+10	+12	8	180	2	15	70
100	B	CT9E	CT9E CR	-36	+12	+15	15	70	4	25	280
220	C	CT9E	CT9E CR	-40	+16	+20	23	36	5	35	510
270	D	CT9E	CT9E CR	-65	+25	+30	26	35	6	40	750
330*	D	CT9E	CT9E CR	-45	+20	+25	23	24	9	36	750
Rated voltage (+85°C) 75 V - 80 V - Category voltage (+125°C) 50 V											
8,2*	A	CT9E	CT9E CR	-16	+12	+12	12	200	1,5	7	60
10*	A	CT9E	CT9E CR	-16	+12	+12	12	175	1,5	7	60
12*	A	CT9E	CT9E CR	-16	+12	+12	12	155	2	9	70
15*	A	CT9E	CT9E CR	-16	+12	+12	12	130	3	12	70
18*	A	CT9E	CT9E CR	-16	+12	+12	12	100	3	12	70
22	A	CT9E	CT9E CR	-19	+10	+12	6	190	2	15	70
39*	B	CT9E	CT9E CR	-25	+15	+15	20	95	3	15	250
47*	B	CT9E	CT9E CR	-25	+15	+15	20	75	3,5	20	260
56*	B	CT9E	CT9E CR	-25	+15	+15	20	70	3,5	20	260
68*	B	CT9E	CT9E CR	-25	+15	+15	12	42	4	24	280
82	B	CT9E	CT9E CR	-30	+12	+15	12	80	4	25	280
100*	C	CT9E	CT9E CR	-30	+16	+20	18	33	8	32	500
120*	C	CT9E	CT9E CR	-30	+16	+20	18	28	8	32	500
150*	C	CT9E	CT9E CR	-30	+16	+20	18	24	8	32	500
180	C	CT9E	CT9E CR	-35	+16	+20	19	36	5	40	510
220	D	CT9E	CT9E CR	-60	+20	+25	21	30	6	40	750
270*	D	CT9E	CT9E CR	-40	+20	+25	18	22	10	40	750
Rated voltage (+85°C) 100 V - Category voltage (+125°C) 63 V											
10	A	CT9E	CT9E CR	-17	+10	+12	4	250	2	15	60
33*	B	CT9E	CT9E CR	-25	+15	+15	15	85	4	24	250
39	B	CT9E	CT9E CR	-20	+12	+15	7	96	4	30	250
43*	B	CT9E	CT9E CR	-25	+10	+10	15	70	5	24	250
47*	B	CT9E	CT9E CR	-25	+10	+10	17	65	5	24	250
56*	C	CT9E	CT9E CR	-30	+10	+15	26	45	5	24	500
68	C	CT9E	CT9E CR	-30	+14	+16	8	50	5	50	500
82*	C	CT9E	CT9E CR	-30	+10	+15	30	30	10	40	500
120	D	CT9E	CT9E CR	-40	+15	+20	15	36	6	50	750
150*	D	CT9E	CT9E CR	-30	+20	+25	25	34	12	48	750
Rated voltage (+85°C) 125 V - Category voltage (+125°C) 80 V											
4,7*	A	CT9E	CT9E CR	-15	+6	+6	4	570	1	2	50
5,6*	A	CT9E	CT9E CR	-18	+9	+10	7	375	3	12	50
6,8	A	CT9E	CT9E CR	-14	+10	+12	4	360	2	15	50
8,2*	A	CT9E	CT9E CR	-17	+12	+12	14	270	4	15	50
18*	B	CT9E	CT9E CR	-20	+15	+15	10	120	2	7	250
22*	B	CT9E	CT9E CR	-20	+15	+15	15	115	2	9	250
27	B	CT9E	CT9E CR	-18	+12	+15	5	110	4	30	250
33*	C	CT9E	CT9E CR	-18	+10	+10	18	90	2	14	500
39*	C	CT9E	CT9E CR	-20	+10	+10	18	72	2	15	500
47	C	CT9E	CT9E CR	-26	+16	+16	6	65	5	50	500
68*	D	CT9E	CT9E CR	-30	+20	+20	20	40	10	40	750
82	D	CT9E	CT9E CR	-30	+16	+17	8	40	6	50	750
100*	D	CT9E	CT9E CR	-30	+20	+25	20	38	12	48	750
120*	D	CT9E	CT9E CR	-30	+20	+25	20	38	12	48	750
Rated voltage (+85°C) 150 V - Category voltage (+125°C) 100 V											
5,6*	A	CT9E	CT9E CR	-18	+16	+16	6	65	5	50	500
14*	B	CT9E	CT9E CR	-20	+20	+20	20	40	10	40	750
22*	B	CT9E	CT9E CR	-20	+16	+17	8	40	6	50	750
39*	C	CT9E	CT9E CR	-30	+20	+25	20	38	12	48	750
56*	D	CT9E	CT9E CR	-30	+20	+25	20	38	12	48	750

* out of CECC range

CT4 CT4E

Wet tantalum capacitors
Epoxy sealed silver cases
Axial leads
Polarized



ELECTRICAL AND CLIMATIC CHARACTERISTICS

	CT4	CT4E
Detail specification	According to CECC 30202-003	According to BS 9073 F008 (CT4E/69F) BS 9073 F032 (CT4E/69FE)
Operating temperature	-55°C +125°C	-55°C +125°C
Damp heat	56 days	56 days
Capacitance range	4,7µF ⇒ 1000µF	1,7µF ⇒ 2200µF
Tolerance	±10% - ±20%	±10% - ±20%
Voltage range	10V ⇒ 125V	6,3V ⇒ 150V
Max. capacitance change -55°C	see table	see table
Max. capacitance change +85°C	see table	see table
Max. capacitance change +125°C	see table	see table
Maximum DF at +20°C	see table	see table
Maximum DF at +85°C	= lim20°C	= lim20°C
Maximum DF at +125°C	= lim20°C	= lim20°C
Max. impedance (100Hz) at -55°C	see table	see table
Max. leakage current at +20°C	see table	see table
Max. leakage current at +85°C	see table	see table
Max. leakage current at +125°C	1,6 x lim+85°C	1,6 x lim+85°C
Max. ripple current 100kHz +85°C	see table	see table
Reverse voltage	No	No
Max. surge voltage at +85°C	1,15 x U _R	1,15 x U _R
Max. surge voltage at +125°C	1,15 x U _C	1,15 x U _C

DIMENSIONS (mm)

Case code	Dimensions with insulating sleeve		
	L max	D max	d +10% -0,05
A	17	5,8	0,6
B	19	7,4	0,6
C	23	10,1	0,6
D	28	10,1	0,6

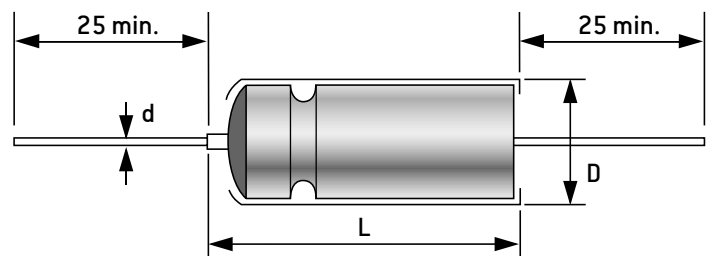

MARKING, PACKAGING, CONSTRUCTION:
see general characteristics

HOW TO ORDER

Commercial description	Model		Case	Capacitance in µF	Tolerance in %	DC Voltage	Termination
		CT4	CT4E	D	120µF	20%	100V
EXXELIA PN	Model code		Case	Capacitance code	Tolerance code	DC Voltage code	Termination
	TS47	TS47E	D	127	M	100	A
	Expressed in pF with 3 digits: 2 digits for the value and the third for the multiplier			K = 10% M = 20%	Expressed in volt with 3 digits	Commercial description H = SnPb (non RoHS) - = Sn100% (RoHS)	EXXELIA PN A = SnPb (non RoHS) F = Sn100% (RoHS)

CT4

[Standard range]

STANDARD RATINGS - ELECTRICAL CHARACTERISTICS

Capacitance 100Hz +20°C (μ F)	Case (code)	Type	Capacitance maximum change			Max. DF +20°C (%)	Max. Impedance 100Hz -55°C (Ω)	Max. I leak		I _{rms} Max. 100kHz +85°C (mA)
			-55°C (%)	+85°C (%)	+125°C (%)			+20°C (μ A)	+85°C (μ A)	
Rated voltage (+85°C) 10 V - Category voltage (+125°C) 6,3 V										
47	A	CT4	-60	+12	+15	32	125	1	5	80
150	B	CT4	-60	+12	+15	36	100	2	10	250
470	C	CT4	-70	+12	+15	45	80	5	25	500
1000	D	CT4	-70	+20	+25	80	50	8	40	850
Rated voltage (+85°C) 16 V - Category voltage (+125°C) 10 V										
33	A	CT4	-50	+12	+15	29	125	1	5	80
100	B	CT4	-50	+12	+15	32	100	2	10	250
330	C	CT4	-60	+12	+15	40	90	5	25	500
680	D	CT4	-70	+20	+25	65	75	8	40	800
Rated voltage (+85°C) 25 V - Category voltage (+125°C) 16 V										
22	A	CT4	-50	+12	+15	22	175	1	5	80
68	B	CT4	-50	+12	+15	27	125	2	10	250
180	C	CT4	-60	+12	+15	32	100	5	25	500
390	D	CT4	-70	+20	+25	50	90	8	40	850
Rated voltage (+85°C) 40 V - Category voltage (+125°C) 25 V										
12	A	CT4	-25	+8	+10	20	400	1	5	60
39	B	CT4	-25	+8	+10	24	125	2	10	250
120	C	CT4	-50	+8	+10	32	100	5	25	500
270	D	CT4	-60	+16	+20	50	90	8	40	820
Rated voltage (+85°C) 63 V - Category voltage (+125°C) 40 V										
8,2	A	CT4	-25	+8	+10	16	400	1	5	60
27	B	CT4	-25	+8	+10	24	175	2	10	250
82	C	CT4	-40	+8	+10	26	125	5	25	500
150	D	CT4	-40	+16	+20	45	100	8	40	750
Rated voltage (+85°C) 100 V - Category voltage (+125°C) 63 V										
5,6	A	CT4	-20	+8	+10	15	500	1	5	60
15	B	CT4	-20	+8	+10	20	300	2	10	250
56	C	CT4	-40	+8	+10	24	125	5	25	500
120	D	CT4	-40	+15	+17	42	100	8	40	750
Rated voltage (+85°C) 110 V - 125 V - Category voltage (+125°C) 80 V										
4,7	A	CT4	-15	+8	+10	15	550	1	5	50
12	B	CT4	-15	+8	+10	15	400	2	10	250
39	C	CT4	-40	+8	+10	18	125	5	25	500
82	D	CT4	-40	+12	+15	40	100	8	40	750

[Extended range]

CT4E

STANDARD RATINGS - ELECTRICAL CHARACTERISTICS

Capacitance 100Hz +20°C (μF)	Case (code)	Type	Capacitance maximum change			Max. DF +20°C (%)	Max. Impedance 100Hz -55°C (Ω)	Max. I leak		I _{rms} Max. 100kHz +85°C (mA)
			-55°C (%)	+85°C (%)	+125°C (%)			+20°C (μA)	+85°C (μA)	
Rated voltage (+85°C) 6 V - 6,3 V - Category voltage (+125°C) 4 V										
27	A	CT4E	-50	+15	+15	9	110	1	2	130
30	A	CT4E - 69F	-40	+12	+12	8	100	1	2	140
68	A	CT4E - 69F	-40	+16	+16	18	59	1	2	160
120	B	CT4E	-50	+20	+20	18	48	1	3	330
140	B	CT4E - 69F	-40	+16	+16	18	40	1	3	330
200	A	CT4E	-58	+13	+13	40	25	2	9	180
220	A	CT4E - 69FE	-65	+16	+16	40	22	2	9	90
270	B	CT4E - 69F	-44	+20	+20	70	25	1	7	270
290	C	CT4E	-70	+20	+20	45	24	2	7	410
330	C	CT4E - 69F	-40	+16	+16	43	22	2	8	410
560	B	CT4E - 69FE	-80	+20	+20	42	21	3	14	210
560	C	CT4E - 69F	-64	+20	+20	110	25	2	13	340
820	B	CT4E - 69FE	-80	+20	+20	68	20	3	14	280
1000	D	CT4E	-80	+25	+25	100	20	3	14	530
1200	C	CT4E - 69FE	-85	+25	+25	82	20	5	20	510
1200	D	CT4E - 69F	-80	+25	+25	60	20	3	12	530
1500	C	CT4E - 69FE	-85	+20	+25	82	10	5	20	540
1800	D	CT4E - 69FE	-80	+25	+25	72	16	7	25	650
2200	D	CT4E - 69FE	-80	+20	+25	80	15	9	30	800
Rated voltage (+85°C) 8 V - Category voltage (+125°C) 5 V										
22	A	CT4E	-50	+15	+15	7	115	1	2	130
25	A	CT4E - 69F	-40	+12	+12	7	100	1	2	140
56	A	CT4E - 69F	-40	+12	+12	15	60	1	2	160
100	B	CT4E	-50	+20	+20	32	52	1	3	330
120	B	CT4E	-50	+20	+20	40	48	1	4	330
180	A	CT4E - 69FE	-54	+13	+16	36	28	2	9	180
220	B	CT4E - 69F	-44	+20	+20	57	30	1	7	270
260	C	CT4E	-70	+20	+20	60	37	2	8,5	410
290	C	CT4E	-70	+20	+20	55	24	2	9,5	410
430	B	CT4E - 69FE	-80	+20	+20	42	20	3	14	280
430	C	CT4E - 69F	-64	+20	+20	84	25	2	14	340
620	B	CT4E - 69FE	-80	+20	+20	53	17	3	14	290
680	B	CT4E - 69FE	-80	+20	+20	55	15	3	14	300
850	C	CT4E - 69FE	-80	+25	+25	65	25	4	16	430
850	D	CT4E - 69F	-80	+25	+25	50	22	4	16	670
1200	C	CT4E - 69FE	-80	+25	+25	82	13	5	20	460
1400	C	CT4E	-85	+20	+25	84	11	5	20	480
1600	D	CT4E - 69FE	-80	+25	+25	68	18	7	25	650
1800	D	CT4E - 69FE	-80	+25	+25	70	16	8	28	670
Rated voltage (+85°C) 10 V - Category voltage (+125°C) 6,3 V										
18	A	CT4E	-40	+15	+15	5	130	1	2	130
20	A	CT4E - 69F	-32	+12	+12	5	120	1	2	140
47	A	CT4E - 69F	-36	+16	+16	15	90	1	2	160
85	B	CT4E	-45	+20	+20	13	61	1	3,5	270
100	A	CT4E - 69FE	-50	+16	+16	15	60	1	4	160
100	B	CT4E - 69F	-36	+16	+16	13	60	1	4	270
120	A	CT4E - 69FE	-45	+13	+16	32	35	2	9	160
140	A	CT4E - 69FE	-50	+16	+16	32	40	2	9	160
150	A	CT4E - 69FE	-50	+16	+16	32	40	2	9	90
180	B	CT4E - 69F	-36	+16	+16	46	40	1	7	270
220	C	CT4E	-60	+20	+20	30	40	2	9	410
250	C	CT4E - 69F	-40	+16	+16	32	35	2	10	410
330	C	CT4E	-64	+20	+20	75	25	2	16	340
390	C	CT4E - 69F	-64	+20	+20	75	25	2	16	340
470	B	CT4E - 69FE	-65	+16	+20	35	16	3	16	300
510	B	CT4E - 69FE	-70	+20	+20	45	15	3	16	300
560	B	CT4E - 69FE	-70	+20	+20	50	21	3	16	280
680	D	CT4E	-72	+25	+30	32	19	8	32	610
750	C	CT4E - 69FE	-75	+25	+25	67	22	5	20	410
750	D	CT4E - 69F	-80	+25	+25	44	23	4	16	670
1000	C	CT4E - 69FE	-75	+20	+25	67	12	5	20	470
1200	C	CT4E	-75	+20	+25	82	12	5	20	540
1200	D	CT4E	-75	+30	+30	60	18	8	32	670
1300	D	CT4E - 69FE	-75	+25	+25	63	17	7	25	670
1500	D	CT4E - 69FE	-75	+25	+25	66	17	8	28	800

CT4E**(Extended range)****STANDARD RATINGS - ELECTRICAL CHARACTERISTICS**

Capacitance 100Hz +20°C (μ F)	Case (code)	Type	Capacitance maximum change			Max. DF +20°C (%)	Max. Impedance 100Hz -55°C (Ω)	Max. I leak		I _{rms} Max. 100kHz +85°C (mA)
			-55°C (%)	+85°C (%)	+125°C (%)			+20°C (μ A)	+85°C (μ A)	
Rated voltage [+85°C] 15 V - 16 V - Category voltage [+125°C] 10 V										
13	A	CT4E	-30	+15	+15	5	160	1	2	120
15	A	CT4E - 69F	-24	+12	+12	5	145	1	2	130
22	A	CT4E	-20	+12	+12	7	140	1	3	160
33	A	CT4E - 69F	-28	+16	+16	10	100	1	2	160
55	B	CT4E	-35	+20	+20	11	70	1	3,5	270
68	B	CT4E	-24	+15	+15	26	60	1	8	270
70	B	CT4E - 69F	-28	+16	+16	11	63	1	4	270
82	A	CT4E	-38	+13	+16	28	45	2	9	160
100	A	CT4E - 69FE	-40	+16	+16	28	40	2	9	80
120	B	CT4E - 69F	-28	+20	+20	27	50	1	7	270
150	C	CT4E	-55	+20	+20	25	40	2	9	410
170	C	CT4E - 69F	-32	+16	+16	22	38	2	10	410
220	B	CT4E - 69FE	-60	+20	+20	24	38	3	16	270
270	B	CT4E - 69FE	-60	+20	+20	30	32	3	16	270
270	C	CT4E - 69F	-56	+20	+20	50	30	2	16	340
330	B	CT4E	-60	+16	+20	30	18	3	16	300
360	B	CT4E - 69FE	-60	+20	+20	38	23	3	16	270
390	B	CT4E - 69FE	-60	+20	+20	38	21	3	16	280
540	C	CT4E - 69FE	-70	+25	+25	45	23	5	20	610
540	D	CT4E - 69F	-80	+25	+25	15	32	3	24	610
560	C	CT4E - 69FE	-70	+25	+25	55	20	5	20	440
680	C	CT4E - 69FE	-65	+20	+25	50	13	5	20	440
750	C	CT4E - 69FE	-70	+25	+25	52	13	6	24	440
820	C	CT4E - 69FE	-70	+15	+20	60	13	6	24	510
820	D	CT4E	-70	+30	+30	60	20	10	40	610
1000	D	CT4E	-70	+30	+30	60	19	10	40	610
1100	D	CT4E - 69FE	-70	+25	+25	53	18	8	25	700
1200	D	CT4E - 69FE	-70	+25	+25	55	17	8	28	750
Rated voltage [+85°C] 20 V - Category voltage [+125°C] 13 V										
82	A	CT4E - 69FE	-40	+16	+16	25	50	2	9	70
270	B	CT4E - 69FE	-60	+20	+20	24	24	3	16	270
330	B	CT4E - 69FE	-60	+20	+20	30	21	3	16	280
560	C	CT4E - 69FE	-70	+15	+20	40	20	5	20	510
1000	D	CT4E - 69FE	-70	+25	+25	40	21	8	28	750
Rated voltage [+85°C] 25 V - Category voltage [+125°C] 16 V										
9	A	CT4E	-20	+15	+15	4	210	1	2	120
10	A	CT4E - 69F	-16	+9	+9	4	190	1	2	130
12	A	CT4E	-16	+12	+12	12	155	2	9	70
15	A	CT4E	-16	+12	+12	12	130	3	12	70
22	A	CT4E - 69F	-20	+12	+12	7	140	1	3	160
39	B	CT4E	-28	+12	+12	18	90	1	9	250
45	B	CT4E	-35	+20	+20	15	78	1	5	270
50	A	CT4E - 69FE	-35	+15	+15	18	80	2	9	160
50	B	CT4E	-35	+20	+20	15	70	1	5	270
68	A	CT4E - 69FE	-35	+12	+15	22	50	2	9	160
100	B	CT4E - 69F	-28	+15	+15	15	50	1	10	270
100	C	CT4E	-50	+20	+20	23	45	2	10	410
110	C	CT4E	-55	+20	+20	25	42	2	11	410
120	C	CT4E	-30	+20	+20	18	28	6	26	420
180	B	CT4E - 69FE	-45	+16	+16	23	40	2	18	270
180	C	CT4E - 69F	-48	+15	+15	46	32	2	18	340
220	B	CT4E - 69FE	-45	+16	+16	24	38	3	16	270
270	B	CT4E - 69FE	-45	+13	+16	24	19	3	16	300
270	D	CT4E	-45	+20	+25	23	23	9	36	550
350	C	CT4E - 69FE	-60	+25	+25	27	26	7	28	410
350	D	CT4E - 69F	-70	+25	+25	25	24	7	28	580
430	C	CT4E - 69FE	-60	+25	+25	27	19	7	28	410
470	C	CT4E - 69FE	-60	+25	+25	33	18	6	24	410
510	C	CT4E - 69FE	-60	+25	+25	33	16	7	28	440
560	C	CT4E	-60	+20	+25	35	14	7	28	440
680	D	CT4E	-72	+25	+30	32	19	8	32	610
750	D	CT4E - 69FE	-60	+25	+25	36	18	8	29	610
820	D	CT4E - 69FE	-60	+25	+25	40	17	9	30	610

(Extended range)**CT4E****STANDARD RATINGS - ELECTRICAL CHARACTERISTICS**

Capacitance 100Hz +20°C (μ F)	Case (code)	Type	Capacitance maximum change			Max. DF +20°C (%)	Max. Impedance 100Hz -55°C (Ω)	Max. I leak		I _{rms} Max. 100kHz +85°C (mA)
			-55°C (%)	+85°C (%)	+125°C (%)			+20°C (μ A)	+85°C (μ A)	
Rated voltage (+85°C) 30 V - Category voltage (+125°C) 20 V										
7	A	CT4E	-20	+15	+15	4	275	1	2	110
8	A	CT4E - 69F	-16	+12	+12	4	235	1	2	130
15	A	CT4E - 69F	-20	+12	+12	8	175	1	2	160
35	B	CT4E	-30	+20	+20	12	85	1	4	230
39	A	CT4E	-28	+10	+12	10	70	2	9	140
40	B	CT4E - 69F	-24	+12	+12	10	80	1	5	270
56	A	CT4E - 69FE	-32	+15	+15	20	55	2	9	70
68	B	CT4E - 69F	-24	+15	+15	26	60	1	8	270
80	C	CT4E	-45	+20	+20	15	52	2	10	410
100	C	CT4E - 69F	-28	+12	+12	16	45	2	12	410
150	B	CT4E - 69FE	-40	+12	+15	20	24	3	16	300
150	C	CT4E - 69F	-48	+15	+15	38	35	2	18	340
180	B	CT4E - 69FE	-40	+13	+16	21	22	3	16	300
200	B	CT4E - 69FE	-40	+16	+16	21	21	3	16	300
220	B	CT4E - 69FE	-40	+16	+16	23	38	3	16	270
300	C	CT4E - 69FE	-55	+25	+25	25	18	7	28	360
300	D	CT4E - 69F	-60	+25	+25	27	25	4	31	550
330	C	CT4E - 69FE	-45	+20	+25	25	16	6	24	440
390	C	CT4E - 69FE	-55	+20	+25	27	15	6	24	510
430	C	CT4E - 69FE	-55	+25	+25	27	15	7	28	440
470	C	CT4E	-55	+20	+25	29	14	8	32	440
470	D	CT4E	-55	+30	+30	25	23	8	32	550
560	D	CT4E	-65	+25	+30	28	20	9	36	590
620	D	CT4E - 69FE	-60	+25	+25	32	22	8	29	590
680	D	CT4E - 69FE	-60	+25	+25	36	20	7	25	750
Rated voltage (+85°C) 35 V - 40 V - Category voltage (+125°C) 23 V - 25 V										
6,8	A	CT4E	-20	+9	+9	4	300	1	2	70
27	B	CT4E	-25	+15	+15	20	90	5	24	250
39	A	CT4E - 69FE	-32	+15	+15	18	80	2	9	70
47	A	CT4E - 69FE	-32	+15	+15	16	60	2	9	70
100	C	CT4E	-30	+20	+20	18	33	8	32	420
150	B	CT4E - 69FE	-40	+16	+16	20	38	3	16	270
150	D	CT4E	-30	+20	+25	25	34	12	48	750
220	D	CT4E	-40	+20	+20	16	24	9	36	450
330	C	CT4E - 69FE	-55	+20	+25	26	25	6	24	500
400	D	CT4E - 69FE	-60	+25	+25	28	31	8	29	750
470	C	CT4E	-55	+20	+20	26	24	7	25	500
470	D	CT4E - 69FE	-55	+20	+20	26	29	7	25	750
480	D	CT4E - 69FE	-60	+25	+25	28	25	8	29	750
560	D	CT4E - 69FE	-60	+25	+25	29	24	8	32	750
Rated voltage (+85°C) 50 V - Category voltage (+125°C) 32 V										
4,5	A	CT4E	-20	+10	+10	3	380	1	2	110
5	A	CT4E - 69F	-16	+6	+6	3	355	1	2	130
5,6	A	CT4E	-16	+12	+12	5	375	3	12	130
10	A	CT4E - 69F	-24	+9	+9	5	250	1	2	160
22	A	CT4E - 69FE	-24	+12	+12	16	125	2	9	130
22	B	CT4E	-25	+20	+20	10	95	1	4	230
25	A	CT4E - 69FE	-24	+12	+12	14	90	1	5	270
25	B	CT4E - 69F	-20	+12	+12	10	90	1	4	270
33	A	CT4E - 69FE	-24	+12	+12	16	120	2	9	70
47	B	CT4E - 69F	-28	+15	+15	18	70	1	9	270
55	C	CT4E	-30	+20	+20	12	55	2	11	410
60	B	CT4E	-25	+12	+15	12	60	4	24	270
60	C	CT4E - 69F	-16	+12	+12	12	50	2	12	410
82	B	CT4E - 69FE	-35	+15	+15	20	45	2	16	270
82	C	CT4E - 69F	-32	+15	+15	21	45	2	16	340
120	B	CT4E - 69FE	-35	+15	+15	18	26	3	18	280
150	C	CT4E - 69FE	-40	+25	+25	30	33	7	28	370
150	D	CT4E	-50	+20	+20	17	29	5	32	460
160	C	CT4E - 69FE	-40	+25	+25	30	32	12	48	370
160	D	CT4E - 69F	-50	+20	+20	15	27	5	32	460
270	C	CT4E - 69FE	-40	+20	+25	24	24	7	28	500
330	D	CT4E	-46	+25	+30	24	22	9	36	550
360	D	CT4E - 69FE	-45	+25	+25	24	21	8	32	750
390	D	CT4E - 69FE	-45	+20	+25	25	20	8	32	750

CT4E**(Extended range)****STANDARD RATINGS - ELECTRICAL CHARACTERISTICS**

Capacitance 100Hz +20°C (μ F)	Case (code)	Type	Capacitance maximum change			Max. DF +20°C (%)	Max. Impedance 100Hz -55°C (Ω)	Max. I leak		Irms Max. 100kHz +85°C (mA)
			-55°C (%)	+85°C (%)	+125°C (%)			+20°C (μ A)	+85°C (μ A)	
Rated voltage (+85°C) 60 V - 63 V - Category voltage (+125°C) 40 V										
3,6	A	CT4E	-20	+10	+10	3	485	1	2	100
4	A	CT4E - 69F	-16	+6	+6	3	405	1	2	110
8,2	A	CT4E - 69F	-24	+9	+9	4	275	1	2	140
18	B	CT4E	-25	+15	+15	7	125	1	4,5	210
20	A	CT4E - 69FE	-20	+12	+12	7	120	1	5	140
20	B	CT4E - 69F	-16	+12	+12	6	105	1	5	270
27	A	CT4E - 69FE	-20	+12	+12	14	90	3	12	70
39	B	CT4E - 69F	-28	+12	+12	18	90	1	9	230
45	C	CT4E	-25	+15	+15	10	57	2	11	410
50	B	CT4E - 69FE	-30	+15	+15	9	60	2	12	230
50	C	CT4E - 69F	-16	+12	+12	9	55	2	12	410
68	B	CT4E	-25	+12	+15	12	60	4	24	270
68	C	CT4E - 69F	-32	+12	+12	27	50	2	16	340
100	B	CT4E - 69FE	-30	+15	+15	15	28	4	20	280
140	C	CT4E - 69FE	-30	+16	+20	18	32	7	28	420
140	D	CT4E - 69F	-40	+20	+20	21	28	8	32	430
220	C	CT4E - 69FE	-35	+15	+20	18	17	7	28	510
270	D	CT4E	-45	+20	+25	23	23	9	36	550
300	D	CT4E - 69FE	-45	+20	+20	21	23	8	32	550
330	D	CT4E - 69FE	-45	+20	+20	23	24	9	36	750
Rated voltage (+85°C) 75 V - 80 V - Category voltage (+125°C) 50 V										
3	A	CT4E	-20	+10	+10	2	625	1	2	100
3,5	A	CT4E - 69F	-16	+6	+6	2	505	1	2	110
6,8	A	CT4E - 69F	-20	+9	+9	4	300	1	2	140
8,2	A	CT4E - 69FE	-16	+12	+12	12	175	1,5	7	140
10	A	CT4E - 69FE	-16	+12	+12	12	165	1,5	7	140
12	A	CT4E - 69FE	-16	+12	+12	12	155	2	9	70
13	B	CT4E	-20	+15	+15	6	160	1	4	190
15	A	CT4E - 69FE	-14	+10	+12	12	150	3	12	140
15	B	CT4E - 69F	-16	+9	+9	6	135	1	5	270
18	A	CT4E - 69FE	-16	+12	+12	12	125	3	12	140
22	A	CT4E - 69FE	-16	+10	+12	12	100	3	12	140
33	B	CT4E - 69F	-24	+15	+15	15	90	1	10	230
35	C	CT4E	-20	+15	+15	13	68	2	11	410
39	B	CT4E - 69FE	-25	+15	+15	20	75	3,5	20	230
40	C	CT4E - 69F	-16	+12	+12	13	60	2	12	410
47	B	CT4E - 69FE	-18	+10	+12	20	75	3,5	20	270
56	B	CT4E - 69FE	-20	+12	+15	20	70	2	16	270
56	C	CT4E - 69F	-28	+15	+15	22	60	2	17	300
68	B	CT4E - 69FE	-25	+15	+15	12	42	4	24	270
82	B	CT4E - 69FE	-25	+12	+15	12	30	4	24	300
82	C	CT4E	-20	+12	+15	18	33	9	36	420
100	C	CT4E - 69FE	-30	+20	+20	18	33	8	32	420
100	D	CT4E	-35	+20	+20	18	31	5	36	420
110	C	CT4E - 69FE	-25	+16	+20	18	33	8	32	420
110	D	CT4E - 69F	-35	+20	+20	15	29	5	36	400
120	C	CT4E - 69FE	-30	+20	+20	18	28	6	26	420
150	C	CT4E - 69FE	-30	+20	+20	18	25	7	28	440
180	C	CT4E - 69FE	-30	+16	+20	18	17	8	32	440
180	D	CT4E	-30	+20	+20	16	28	9	36	470
220	D	CT4E - 69FE	-40	+20	+20	16	24	9	36	450
240	D	CT4E - 69FE	-40	+20	+20	17	23	9	36	450
270	D	CT4E - 69FE	-40	+20	+20	18	22	10	40	450

[Extended range]

CT4E

STANDARD RATINGS - ELECTRICAL CHARACTERISTICS

Capacitance 100Hz +20°C (μ F)	Case (code)	Type	Capacitance maximum change			Max. DF +20°C (%)	Max. Impedance 100Hz -55°C (Ω)	Max. I leak		I _{rms} Max. 100kHz +85°C (mA)
			-55°C (%)	+85°C (%)	+125°C (%)			+20°C (μ A)	+85°C (μ A)	
Rated voltage (+85°C) 100 V - Category voltage (+125°C) 63 V										
2,5	A	CT4E - 69F	-15	+4	+4	2	710	1	2	100
4,7	A	CT4E - 69F	-16	+6	+6	3	500	1	2	130
8,2	A	CT4E	-12	+12	+12	12	250	3	12	130
10	A	CT4E - 69FE	-12	+12	+12	12	200	3	12	130
10	B	CT4E	-16	+12	+12	12	200	3	12	60
11	B	CT4E - 69F	-15	+6	+6	4	200	1	4	230
22	B	CT4E - 69F	-16	+6	+6	10	100	1	9	230
27	C	CT4E	-20	+15	+15	8	90	2	11	230
30	C	CT4E - 69F	-15	+8	+8	8	85	2	12	340
33	B	CT4E	-18	+15	+15	20	85	4	24	250
39	B	CT4E - 69FE	-18	+15	+15	20	80	4	24	250
43	C	CT4E - 69F	-20	+8	+8	16	70	2	17	300
47	B	CT4E	-25	+10	+10	17	65	5	24	250
56	C	CT4E	-20	+15	+15	18	45	9	36	400
68	C	CT4E - 69FE	-20	+15	+15	18	40	9	36	400
68	D	CT4E	-25	+15	+15	25	40	6	30	450
82	C	CT4E	-30	+10	+15	30	30	10	40	500
86	D	CT4E - 69F	-25	+15	+15	15	30	5	35	370
120	D	CT4E - 69FE	-40	+20	+20	25	36	12	48	450
150	D	CT4E	-30	+20	+25	25	34	12	48	750
Rated voltage (+85°C) 125 V - Category voltage (+125°C) 80 V										
1,7	A	CT4E - 69F	-15	+4	+4	2	1090	1	2	100
3,6	A	CT4E - 69F	-16	+5	+5	4	615	1	2	110
6,8	A	CT4E - 69FE	-16	+12	+12	12	300	3	12	130
8,2	A	CT4E	-17	+12	+12	14	270	4	15	50
9	A	CT4E - 69FE	-16	+12	+12	12	250	4	15	130
9	B	CT4E - 69F	-15	+6	+6	9	220	1	5	210
10	B	CT4E	-16	+10	+10	10	210	1	5	190
14	B	CT4E - 69F	-16	+7	+7	10	160	1	7	190
18	C	CT4E	-15	+10	+10	16	135	4	12	340
25	C	CT4E - 69F	-16	+10	+10	16	120	2	13	260
27	B	CT4E - 69FE	-25	+15	+15	20	90	5	24	250
47	C	CT4E - 69FE	-30	+10	+15	18	50	10	40	500
56	D	CT4E	-25	+15	+15	18	32	10	40	330
80	D	CT4E - 69F	-20	+20	+20	20	34	9	50	400
82	D	CT4E - 69FE	-40	+20	+20	25	40	12	48	400
120	D	CT4E	-30	+20	+25	20	38	12	48	750
Rated voltage (+85°C) 150 V - Category voltage (+125°C) 100 V										
3	A	CT4E	-20	+15	+15	15	750	1	4	100
6,8	B	CT4E	-15	+10	+10	15	300	2	5	190
11	B	CT4E	-20	+15	+15	15	200	2	12	190
14	C	CT4E	-15	+10	+10	20	175	4	24	260
22	C	CT4E	-20	+15	+15	20	136	4	24	260

AP31



Parallel assembly of wet tantalum capacitors

High capacitance

Polarized

ELECTRICAL AND CLIMATIC CHARACTERISTICS

	AP31
Operating temperature	-55°C +125°C
Capacitance range	170µF ⇔ 30 000µF
Tolerance	± 10% - ± 20%
Voltage range	10V ⇔ 150V
Max. capacitance change -55°C	see table
Max. capacitance change +85°C	see table
Max. capacitance change +125°C	see table
Max. impedance (100Hz) at -55°C	see table
Max. leakage current at +20°C	see table
Max. leakage current at +85°C	see table
Max. leakage current at +125°C	= lim+85°C
Max. ripple current 40kHz +85°C	see table
Reverse voltage	No
Max. surge voltage at +85°C	1,15 x U _R
Max. surge voltage at +125°C	1,15 x U _C

DIMENSIONS (mm)

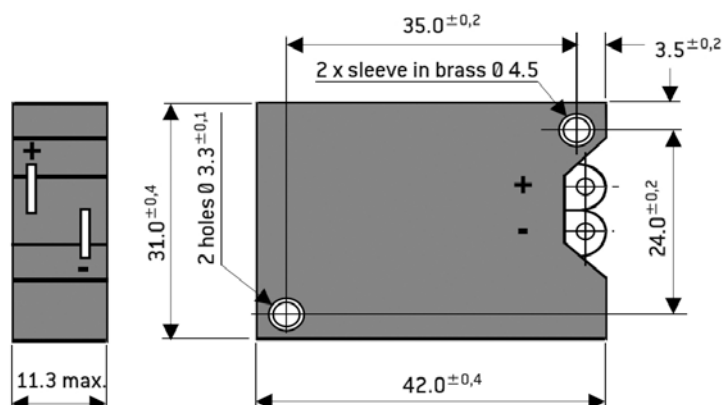

MARKING, PACKAGING, CONSTRUCTION:
see general characteristics

HOW TO ORDER

Commercial description	Model	Capacitance in µF	Tolerance in %	DC Voltage	Termination	
	AP31N	30000µF	20%	10V	H	
EXXELIA PN	Model code	Capacitance code	Tolerance code	DC Voltage code	Termination	
	AP31N	309	M	010	A	
		Expressed in pF with 3 digits: 2 digits for the value and the third for the multiplier	K = 10% M = 20%	Expressed in volt with 3 digits	Commercial description H = SnPb (non RoHS) - = Sn100% (RoHS)	EXXELIA PN A = SnPb (non RoHS) F = Sn100% (RoHS)

STANDARD RATINGS - ELECTRICAL CHARACTERISTICS

Capacitance 100Hz +20°C (μ F)	Max. Impedance 100Hz -55°C (Ω)	Capacitance maximum change			I rms Max.40kHz 100Hz (A)	Max. ESR		Max. I leak	
		-55°C (%)	+85°C (%)	+125°C (%)		100Hz (Ω)	40kHz (Ω)	+20°C (μ A)	+85°C (μ A)
Rated voltage 10V (+85°C) – 6.7V (+125°C)									
30000	1.2	-85	+20	+35	15	85	34	75	450
Rated voltage 16V (+85°C) – 10V (+125°C)									
18000	1.0	-80	+15	+20	13.5	100	40	75	450
Rated voltage 25V (+85°C) – 16V (+125°C)									
5400	2	-75	+12	+20	9.3	167	67	12	75
12000	1.7	-80	+15	+20	12.7	117	47	75	375
Rated voltage 30V (+85°C) – 20V (+125°C)									
4500	1.7	-60	+10	+20	9	200	67	15	90
9900	1.33	-80	+20	+25	8.3	117	47	75	375
Rated voltage 40V (+85°C) – 26V (+125°C)									
3000	2.6	-60	+10	+20	8.3	234	81	24	195
8400	1.5	-80	+20	+30	12	117	47	75	375
Rated voltage 50V (+85°C) – 33V (+125°C)									
2000	2	-60	+10	+20	8.3	200	67	15	120
2250	2.7	-60	+10	+20	8.3	234	90	18	165
4500	2	-70	+20	+20	10.5	117	47	45	330
6600	1.5	-80	+25	+30	9	200	80	75	375
Rated voltage 60V (+85°C) – 40V (+125°C)									
1700	2.7	-60	+8	+15	8.3	267	100	15	120
2100	2.7	-60	+8	+15	8.3	234	90	21	180
3000	1.9	-40	+10	+15	10.5	170	70	60	360
3600	2	-70	+15	+20	10.5	170	70	60	600
Rated voltage 75V (+85°C) – 50V (+125°C)									
1400	3.4	-60	+6	+10	8.3	300	100	15	150
2250	2.2	-35	+10	+15	10.5	170	70	60	360
3000	2.7	-65	+12	+20	10.5	200	80	60	600
Rated voltage 100V (+85°C) – 65V (+125°C)									
660	5	-50	+6	+6	8.3	400	134	15	150
1200	5	-40	+6	+12	9	235	95	30	360
1400	3.4	-50	+10	+20	10.5	235	95	75	750
Rated voltage 125V (+85°C) – 85V (+125°C)									
450	6	-35	+6	+12	7.5	270	107	45	450
720	6.7	-35	+6	+12	7.5	270	107	45	450
1000	5	-55	+8	+12	7.5	270	107	75	750
Rated voltage 150V (+85°C) – 100V (+125°C)									
170	16	-24	+15	+15	5.6	260	105	8.1	81
250	13	-24	+18	+18	5.6	185	75	8.1	81

AP41



Parallel assembly of wet tantalum capacitors

Very high capacitance

Polarized

ELECTRICAL AND CLIMATIC CHARACTERISTICS

	AP41
Operating temperature	-55°C +125°C
Capacitance range	330μF ⇒ 40 000μF
Tolerance	± 10% - ± 20%
Voltage range	10V ⇒ 150V
Max. capacitance change -55°C	see table
Max. capacitance change +85°C	see table
Max. capacitance change +125°C	see table
Max. impedance (100Hz) at -55°C	see table
Max. leakage current at +20°C	see table
Max. leakage current at +85°C	see table
Max. leakage current at +125°C	= lim+85°C
Max. ripple current 40kHz +85°C	see table
Reverse voltage	No
Max. surge voltage at +85°C	1,15 x U _R
Max. surge voltage at +125°C	1,15 x U _C

DIMENSIONS (mm)

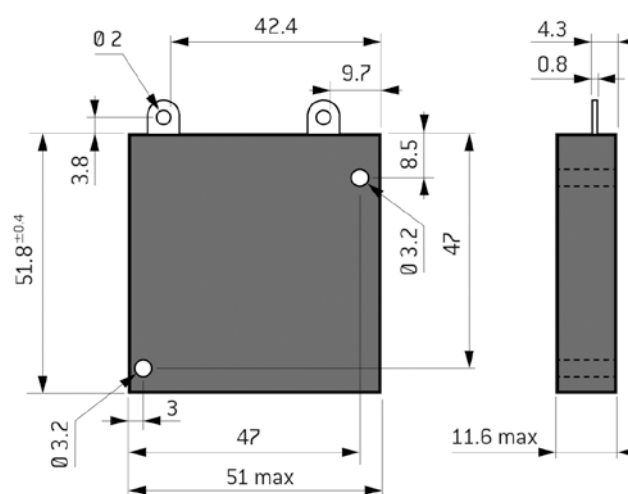

MARKING, PACKAGING, CONSTRUCTION:
see general characteristics

HOW TO ORDER

Commercial description	Model	Capacitance in μF	Tolerance in %	DC Voltage	Termination	
EXXELIA PN	AP41N	40000μF	20%	10V	H	
	Model code	Capacitance code	Tolerance code	DC Voltage code	Termination	
	AP41N	409	M	010	A	
	Expressed in pF with 3 digits: 2 digits for the value and the third for the multiplier		K = 10% M = 20%	Expressed in volt with 3 digits	Commercial description H = SnPb (non RoHS) - = Sn100% (RoHS)	EXXELIA PN A = SnPb (non RoHS) F = Sn100% (RoHS)

STANDARD RATINGS - ELECTRICAL CHARACTERISTICS

Capacitance 100Hz +20°C (μ F)	Max. Impedance +20°C (Ω)	Capacitance maximum change			I _{rms} Max. 40kHz 100Hz (A)	Max. ESR		Max. I leak	
		-55°C (%)	+85°C (%)	+125°C (%)		100Hz (Ω)	40kHz (Ω)	+20°C (μ A)	+85°C (μ A)
Rated voltage 10V (+85°C) – 6.7V (+125°C)									
40000	0.9	-85	+20	+35	20	64	26	100	600
Rated voltage 16V (+85°C) – 10V (+125°C)									
24000	0.75	-80	+15	+20	18	75	30	100	600
Rated voltage 25V (+85°C) – 16V (+125°C)									
7200	1.5	-75	+12	+20	12.4	125	50	16	100
160000	2.3	-80	+15	+20	17	88	35	100	500
Rated voltage 30V (+85°C) – 20V (+125°C)									
6000	1.3	-60	+10	+20	12	150	50	20	120
13200	2.3	-80	+20	+25	14.6	88	35	100	500
Rated voltage 40V (+85°C) – 26V (+125°C)									
4000	1.9	-60	+10	+20	11	175	63	32	350
11200	1.1	-80	+20	+30	16	88	35	100	500
Rated voltage 50V (+85°C) – 33V (+125°C)									
3000	2	-60	+10	+20	11	175	68	24	220
6000	1.5	-70	+20	+20	14	88	35	60	440
8800	1.1	-80	+25	+30	12	150	60	100	500
Rated voltage 60V (+85°C) – 40V (+125°C)									
4000	1.4	-40	+10	+15	14	127	52	80	480
4800	1.5	-70	+15	+20	14	127	52	80	800
Rated voltage 75V (+85°C) – 50V (+125°C)									
4000	2	-65	+12	+20	14	150	60	80	800
Rated voltage 100V (+85°C) – 65V (+125°C)									
1600	3.7	-40	+6	+12	12	176	71	40	480
1400	2.5	-50	+10	+20	14	176	71	100	1000
Rated voltage 125V (+85°C) – 85V (+125°C)									
1330	3.7	-55	+8	+12	10	200	80	100	1000
Rated voltage 150V (+85°C) – 100V (+125°C)									
330	9.7	-24	+18	+18	7.5	135	55	10.8	108

AS31



Serial assembly of capacitors
Very high voltage
 Polarized

ELECTRICAL AND CLIMATIC CHARACTERISTICS

	AS31
Operating temperature	-55°C +125°C
Capacitance range	18μF ⇨ 733μF
Tolerance	± 10% - ± 20%
Voltage range	150V ⇨ 450V
Max. capacitance change -55°C	see table
Max. capacitance change +85°C	see table
Max. capacitance change +125°C	see table
Max. impedance (100Hz) at -55°C	see table
Max. leakage current at +20°C	see table
Max. leakage current at +85°C	see table
Max. leakage current at +125°C	= lim+85°C
Max. ripple current 40kHz +85°C	see table
Reverse voltage	No
Max. surge voltage at +85°C	1,15 x U _R
Max. surge voltage at +125°C	1,15 x U _C

DIMENSIONS (mm)

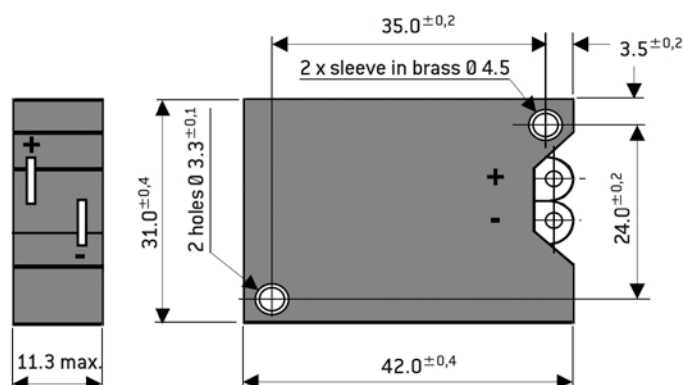

MARKING, PACKAGING, CONSTRUCTION:
 see general characteristics

HOW TO ORDER

Commercial description	Model	Capacitance in μF	Tolerance in %	DC Voltage	Termination	
	AS31N	500μF	20%	150V	H	
EXXELIA PN	Model code	Capacitance code	Tolerance code	DC Voltage code	Termination	
	AS31N	507	M	150	A	
		Expressed in pF with 3 digits: 2 digits for the value and the third for the multiplier	K = 10% M = 20%	Expressed in volt with 3 digits	Commercial description H = SnPb (non RoHS) - = Sn100% (RoHS)	EXXELIA PN A = SnPb (non RoHS) F = Sn100% (RoHS)

STANDARD RATINGS - ELECTRICAL CHARACTERISTICS

Capacitance 100Hz +20°C [μF]	Max. Impedance +20°C [Ω]	Capacitance maximum change			I _{rms} Max.40kHz 100Hz [A]	Max. ESR		Max. I leak	
		-55°C [%]	+85°C [%]	+125°C [%]		100Hz [Ω]	40kHz [Ω]	+20°C [μA]	+85°C [μA]
Rated voltage 150V (+85°C) – 100V (+125°C)									
500	18	-70	+20	+20	3.5	1050	420	15	110
733	13.5	-80	+25	+30	3	1800	720	25	125
Rated voltage 180V (+85°C) – 120V (+125°C)									
186	24	-60	+8	+15	2.75	2400	900	5	40
230	24	-60	+8	+15	2.75	2100	810	7	60
330	16.5	-40	+10	+15	3.5	1500	600	20	120
400	18	-70	+15	+20	3.5	1500	600	20	200
Rated voltage 225V (+85°C) – 150V (+125°C)									
156	30	-60	+6	+10	2.75	2700	900	5	50
250	19.5	-35	+10	+15	3.5	1500	600	20	120
333	24	-65	+12	+20	3.5	1800	720	20	200
Rated voltage 300V (+85°C) – 200V (+125°C)									
73	45	-50	+6	+6	2.75	4800	2100	2	10
133	45	-40	+6	+12	2.5	2400	960	15	150
110	45	-55	+8	+12	2.5	2400	960	25	250
Rated voltage 375V (+85°C) – 250V (+125°C)									
50	54	-35	+6	+12	2.75	4800	1800	5	50
80	60	-35	+6	+12	2.5	2400	960	15	150
110	45	-55	+8	+12	2.5	2400	960	25	250
Rated voltage 450V (+85°C) – 300V (+125°C)									
18.6	141	-24	+15	+15	1.86	2310	920	3	30
273	117	-24	+15	+15	1.86	1650	660	3	30

SPE0844



Parallel assembly of wet tantalum capacitors
High ripple current
 Polarized

ELECTRICAL AND CLIMATIC CHARACTERISTICS

	SPE0844
Operating temperature	-55°C +125°C
Damp heat	56 days
Capacitance range	220µF ⇒ 6000µF
Tolerance	± 10% - ± 20%
Voltage range	6V ⇒ 125V
Max. capacitance change -55°C	see table
Max. capacitance change +85°C	see table
Max. capacitance change +125°C	see table
Maximum DF at +20°C	see table
Maximum DF at -55°C	see table
Maximum DF at +125°C	see table
Max. Impedance at -55°C	see table
Max. leakage current at +20°C	see table
Max. leakage current at +85°C	see table
Max. leakage current at +125°C	see table
Max. ripple current 40kHz +85°C	see table
Max. Reverse voltage at +20°C	3 volts
Max. Reverse voltage at +85°C	3 volts
Max. Reverse voltage at +125°C	3 volts
Max. surge voltage at +85°C	1.15 x U _R
Max. surge voltage at +125°C	1.15 x U _C

DIMENSIONS (mm)

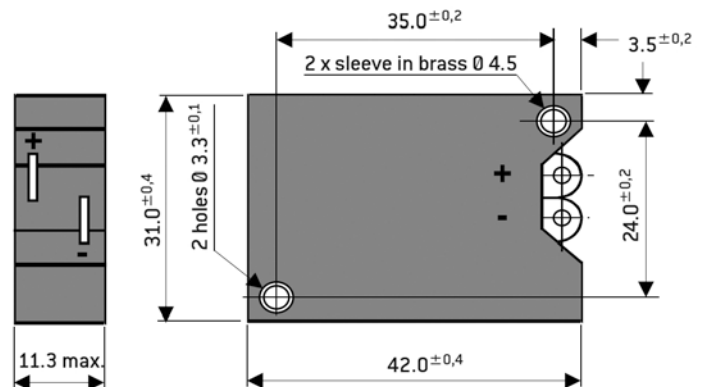

MARKING, PACKAGING, CONSTRUCTION:
 see general characteristics

HOW TO ORDER

Commercial description	Model	Capacitance in µF	Tolerance in %	DC Voltage	Termination	
	SPE0844	5100µF	20%	10V	H	
EXXELIA PN	Model code	Capacitance code	Tolerance code	DC Voltage code	Termination	
	TS4884403	518	M	010	A	
		Expressed in pF with 3 digits: 2 digits for the value and the third for the multiplier	K = 10% M = 20%	Expressed in volt with 3 digits	Commercial description H = SnPb (non RoHS) - = Sn100% (RoHS)	EXXELIA PN A = SnPb (non RoHS) F = Sn100% (RoHS)

SPE0844

STANDARD RATINGS - ELECTRICAL CHARACTERISTICS

Capacitance 100Hz +20°C (µF)	Type	Capacitance maximum change			Max. I leak		Max. DF 100Hz			Max. Impedance 100Hz -55°C (Ω)	I _{rms} Max. 40kHz +85°C (A)
		-55°C (%)	+85°C (%)	+125°C (%)	+20°C (µA)	+85°C +125°C (µA)	+20°C (%)	-55°C (%)	+125°C (%)		
Rated voltage (+85°C) 6 V - Category voltage (+125°C) 4 V											
6000	SPE0844	-90	25	25	18	54	170	1360	170	22	5,7
Rated voltage (+85°C) 6,3 V - Category voltage (+125°C) 4 V											
5600	SPE0844	-90	25	25	18	54	170	1240	170	22	5,7
Rated voltage (+85°C) 8 V - Category voltage (+125°C) 5 V											
5000	SPE0844	-88	25	25	21	75	138	1000	138	24	5,7
Rated voltage (+85°C) 10 V - Category voltage (+125°C) 6,3 V											
3900	SPE0844	-88	25	25	21	75	114	920	114	23	5,7
4100	SPE0844	-88	25	25	21	75	114	950	114	23	5,7
4700	SPE0844	-88	25	25	21	75	114	1000	114	23	5,7
5100	SPE0844	-88	25	25	21	75	138	1100	138	24	5,7
Rated voltage (+85°C) 15 V - Category voltage (+125°C) 10 V											
3400	SPE0844	-84	25	25	24	96	103	900	103	25	5,5
Rated voltage (+85°C) 16 V - Category voltage (+125°C) 10 V											
3300	SPE0844	-84	25	25	24	96	103	850	103	25	5,5
Rated voltage (+85°C) 20 V - Category voltage (+125°C) 13 V											
2350	SPE0844	-80	25	25	24	96	60	700	60	24	4,7
2600	SPE0844	-80	25	25	24	96	95	800	95	24	4,7
2800	SPE0844	-80	25	25	24	96	95	800	95	26	4,7
Rated voltage (+85°C) 25 V - Category voltage (+125°C) 16 V											
1500	SPE0844	-80	25	25	24	96	60	450	60	24	4,7
1800	SPE0844	-80	25	25	24	96	60	500	60	24	4,7
1950	SPE0844	-80	25	25	24	96	60	550	60	24	4,7
2200	SPE0844	-80	25	25	24	96	60	650	60	24	4,7
2400	SPE0844	-80	25	25	24	96	95	700	95	26	4,7
Rated voltage (+85°C) 30 V - Category voltage (+125°C) 20 V											
1350	SPE0844	-80	25	25	27	108	45	400	45	24	4,6
1650	SPE0844	-80	25	25	27	108	40	450	40	24	4,7
Rated voltage (+85°C) 40 V - Category voltage (+125°C) 25 V											
1200	SPE0844	-75	25	25	24	96	43	400	43	24	4,6
1300	SPE0844	-80	25	25	27	108	45	450	45	24	4,6
Rated voltage (+85°C) 50 V - Category voltage (+125°C) 30 V											
900	SPE0844	-70	25	25	27	108	40	280	40	33	4,4
1100	SPE0844	-70	25	25	27	108	40	360	40	30	4,6
Rated voltage (+85°C) 63 V - Category voltage (+125°C) 40 V											
750	SPE0844	-70	24	25	27	108	40	200	40	33	4,4
820	SPE0844	-70	24	25	27	108	40	200	40	33	4,4
1000	SPE0844	-72	25	25	30	120	32	300	32	31	4,5

SPE0844

STANDARD RATINGS - ELECTRICAL CHARACTERISTICS

Capacitance 100Hz +20°C (μ F)	Type	Capacitance maximum change			Max. I leak		Max. DF 100Hz			Max. Impedance 100Hz -55°C (Ω)	I _{rms} Max. 40kHz +85°C (A)
		-55°C (%)	+85°C (%)	+125°C (%)	+20°C (μ A)	+85°C +125°C (μ A)	+20°C (%)	-55°C (%)	+125°C (%)		
Rated voltage (+85°C) 75 V - Category voltage (+125°C) 50 V											
330	SPE0844	-35	20	20	9	72	11	120	13	29	4,8
340	SPE0844	-35	20	20	9	72	11	120	13	29	4,8
390	SPE0844	-36	20	20	9	72	12	120	13	28	4,6
410	SPE0844	-48	21	22	27	108	17	160	18	30	4,6
470	SPE0844	-48	21	22	27	108	17	160	18	30	4,6
500	SPE0844	-48	21	22	27	108	17	300	18	30	4,6
560	SPE0844	-60	22	22	30	120	37	300	37	32	4,5
600	SPE0844	-60	22	22	30	120	37	320	37	32	4,5
680	SPE0844	-60	22	22	30	120	37	320	37	32	4,5
750	SPE0844	-68	24	25	30	120	40	340	40	33	4,5
Rated voltage (+85°C) 80 V - Category voltage (+125°C) 50 V											
820	SPE0844	-68	+25	+25	33	132	42	360	42	30	4,5
Rated voltage (+85°C) 100 V - Category voltage (+125°C) 63 V											
270	SPE0844	-24	15	15	9	72	8	85	11	42	4,5
280	SPE0844	-24	18	15	9	72	10	85	12	39	4,5
300	SPE0844	-24	20	15	9	72	10	90	12	30	4,5
Rated voltage (+85°C) 125 V - Category voltage (+125°C) 83 V											
220	SPE0844	-35	20	20	9	72	11	100	13	36	4,5
235	SPE0844	-35	20	20	9	72	11	100	13	36	4,5

SPE0844S



Serial assembly of wet tantalum capacitors
Very high voltage
 Polarized

ELECTRICAL AND CLIMATIC CHARACTERISTICS

	SPE0844S
Operating temperature	-55°C +125°C
Damp heat	56 days
Capacitance range	27µF ⇒ 150µF
Tolerance	± 10% - ± 20%
Voltage range	150V ⇒ 375V
Max. capacitance change -55°C	see table
Max. capacitance change +85°C	see table
Max. capacitance change +125°C	see table
Maximum DF at +20°C	see table
Maximum DF at -55°C	see table
Maximum DF at +125°C	see table
Max. Impedance at -55°C	see table
Max. leakage current at +20°C	see table
Max. leakage current at +85°C	see table
Max. leakage current at +125°C	see table
Max. ripple current 40kHz +85°C	see table
Max. Reverse voltage at +20°C	3 volts
Max. Reverse voltage at +85°C	3 volts
Max. Reverse voltage at +125°C	3 volts
Max. surge voltage at +85°C	1.15 x U _R
Max. surge voltage at +125°C	1.15 x U _C

DIMENSIONS (mm)

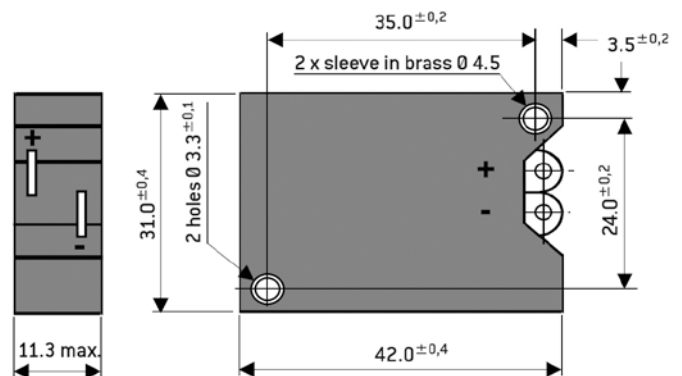

MARKING, PACKAGING, CONSTRUCTION:
 see general characteristics

HOW TO ORDER

Commercial description	Model	Capacitance in µF	Tolerance in %	DC Voltage	Termination
	SPE0844S	150µF	20%	150V	H
EXXELIA PN	Model code	Capacitance code	Tolerance code	DC Voltage code	Termination
	TS4884S03	157	M	150	A

Expressed in pF with 3 digits: 2 digits for the value and the third for the multiplier

K = 10%
 M = 20%

Expressed in volt with 3 digits

Commercial description
 H = SnPb (non RoHS)
 - = Sn100% (RoHS)

EXXELIA PN
 A = SnPb (non RoHS)
 F = Sn100% (RoHS)

SPE0844S

STANDARD RATINGS - ELECTRICAL CHARACTERISTICS

Capacitance 100Hz +20°C (μ F)	Type	Max. I leak +20°C (μ A)	Max. DF 100Hz +20°C (%)	Irms Max. 40kHz +85°C (A)
Rated voltage (+85°C) 150 V - Category voltage (+125°C) 90 V				
150	SPE0844S	3	45	1,5
Rated voltage (+85°C) 180 V - Category voltage (+125°C) 120 V				
100	SPE0844S	3	32	1,5
Rated voltage (+85°C) 220 V - Category voltage (+125°C) 150 V				
68	SPE0844S	3	37	1,5
Rated voltage (+85°C) 300 V - Category voltage (+125°C) 190 V				
33	SPE0844S	3	11	1,5
Rated voltage (+85°C) 375 V - Category voltage (+125°C) 250 V				
27	SPE0844S	3	10	1,5

SOLID TANTALUM POLYMER CAPACITORS

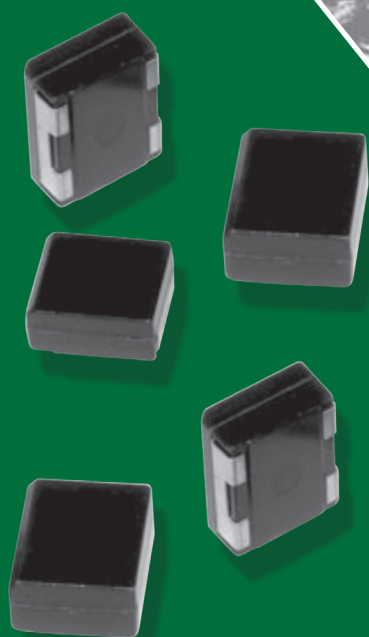

General Information

OVERVIEW

The construction of solid tantalum polymer capacitors is similar to the one of solid tantalum MnO₂ capacitors: the anode is made of tantalum and its oxide constitutes the dielectric, the cathode is made of a conductive polymer to replace MnO₂.

CONSTRUCTION

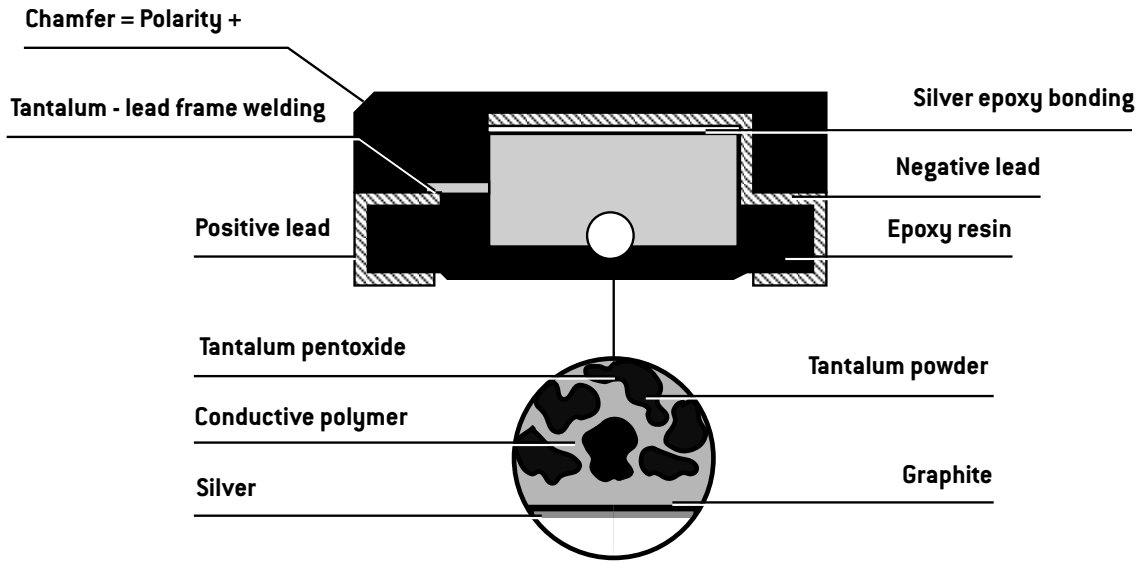

Benefits of conductive polymer used as a cathode are a better conductivity and a higher retention frequency which enable to reach a very low ESR.

The second advantage of conductive polymer as compare to manganese oxide is a self-healing mechanism which is less exothermic avoiding ignition failures.

RECOMMENDED MOUNTING PAD GEOMETRY

Vapor phase or infrared soldering (in mm)

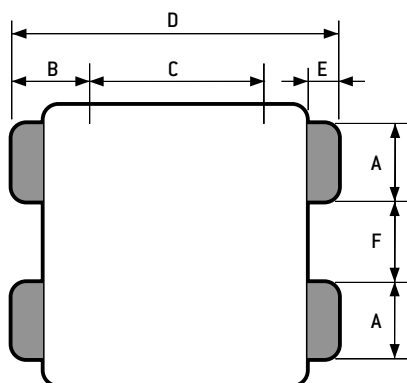

MARKING

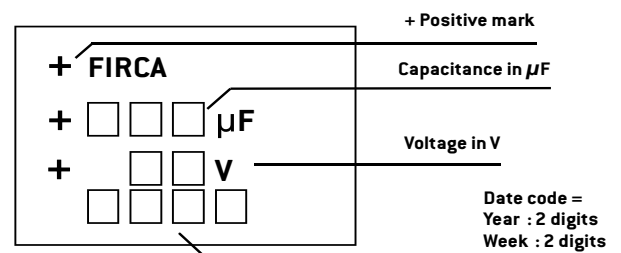

Case code	Dimensions (mm)					
	A min.	B nom.	C nom.	D nom.	E nom.	F nom.
D	3,6	3,3	7,6	14,2	1,35	3,8

General Information

CAPACITANCE CHANGE VS FREQUENCY (TYPICAL)

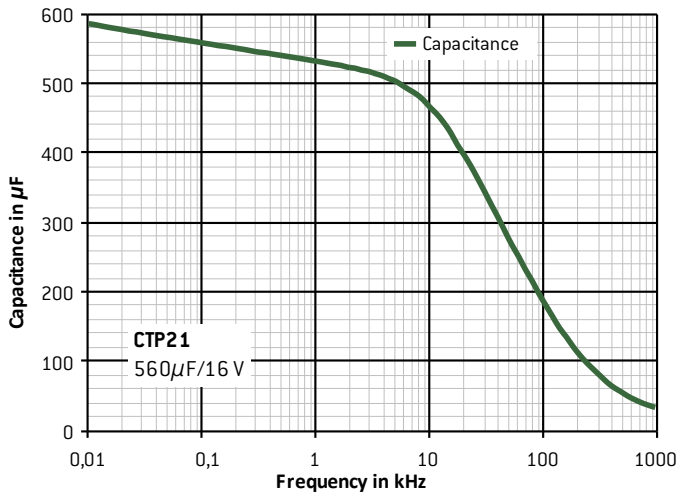

ESR CHANGE VS FREQUENCY (TYPICAL)

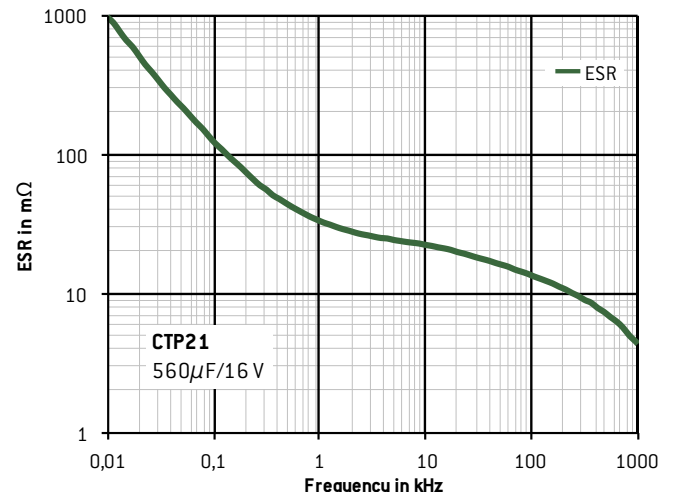

CAPACITANCE CHANGE VS FREQUENCY (TYPICAL)

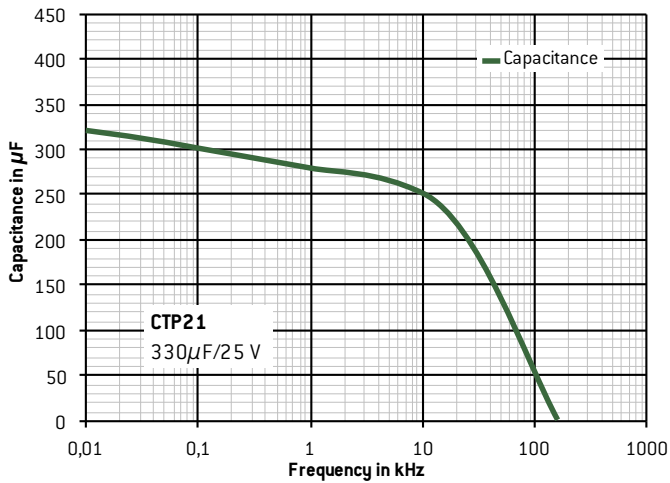

ESR CHANGE VS FREQUENCY (TYPICAL)

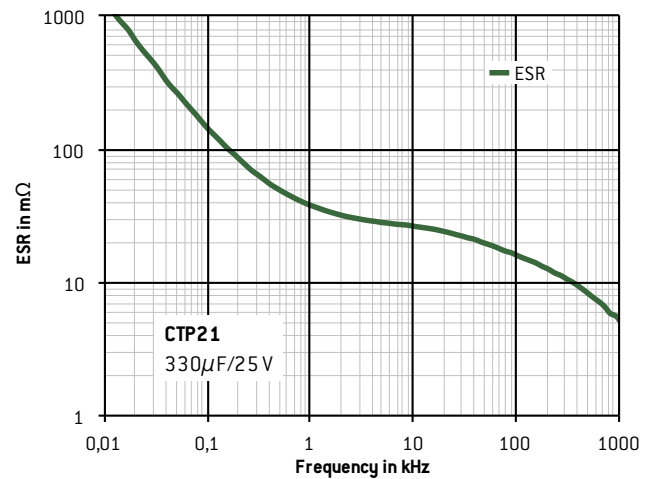

CAPACITANCE CHANGE VS FREQUENCY (TYPICAL)

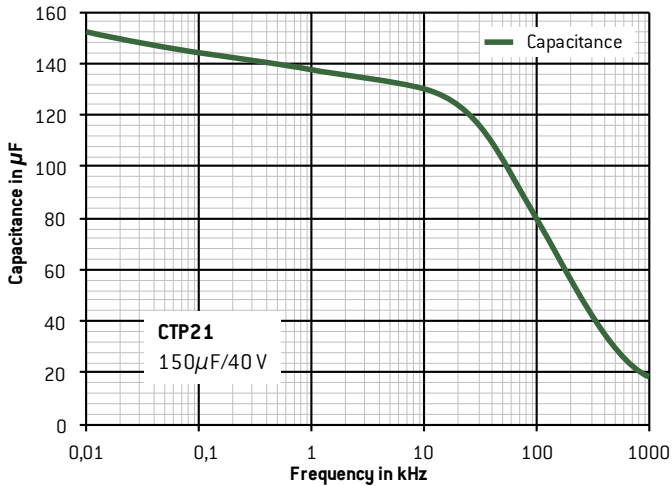

ESR CHANGE VS FREQUENCY (TYPICAL)

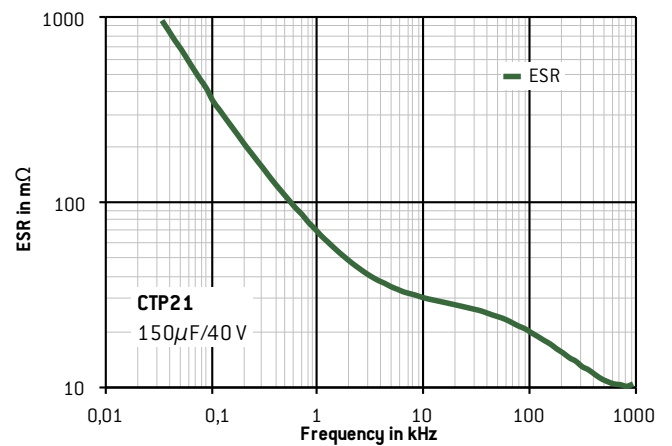

General Information

CAPACITANCE CHANGE VS FREQUENCY (TYPICAL)

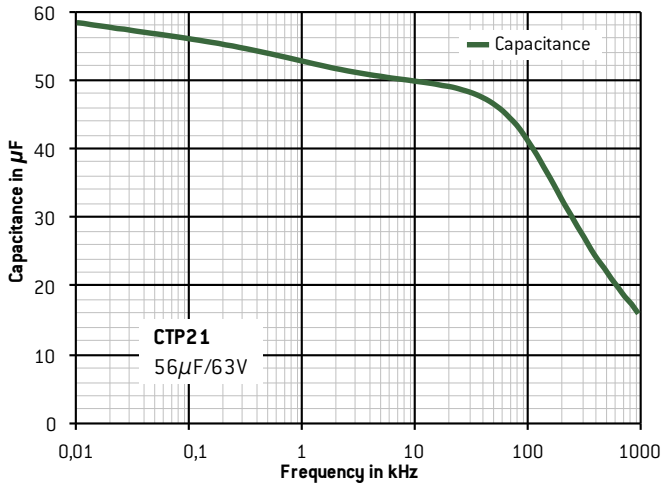

ESR CHANGE VS FREQUENCY (TYPICAL)

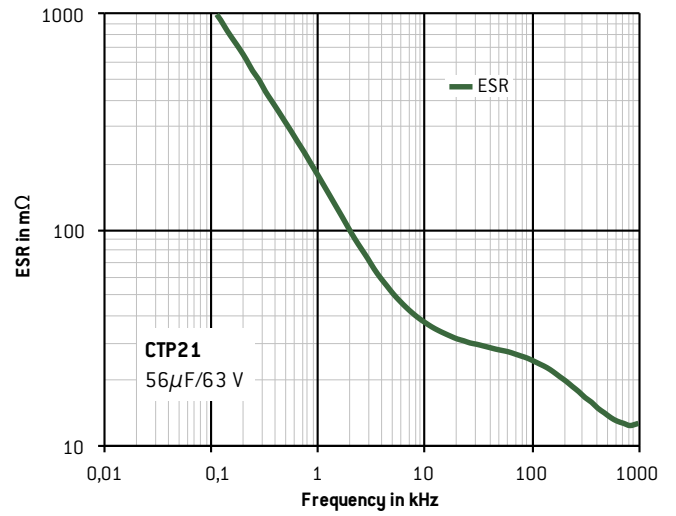

CAPACITANCE CHANGE VS FREQUENCY (TYPICAL)

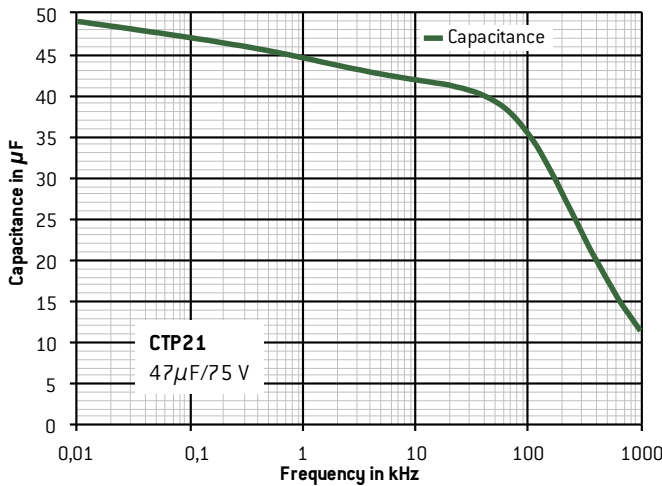

ESR CHANGE VS FREQUENCY (TYPICAL)

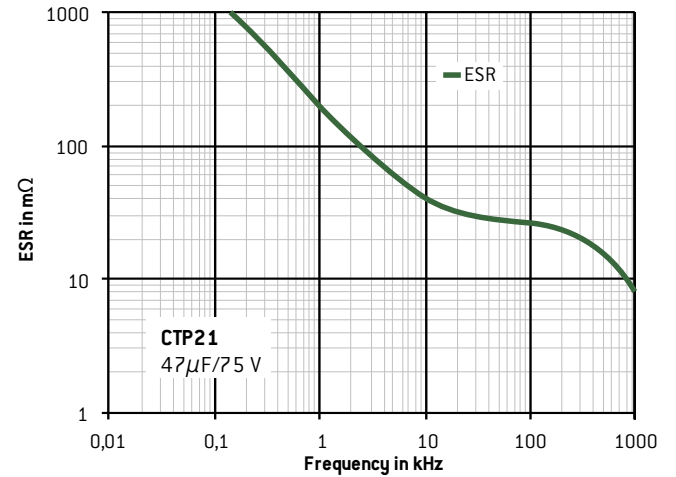

General Information

CAPACITANCE CHANGE VS TEMPERATURE

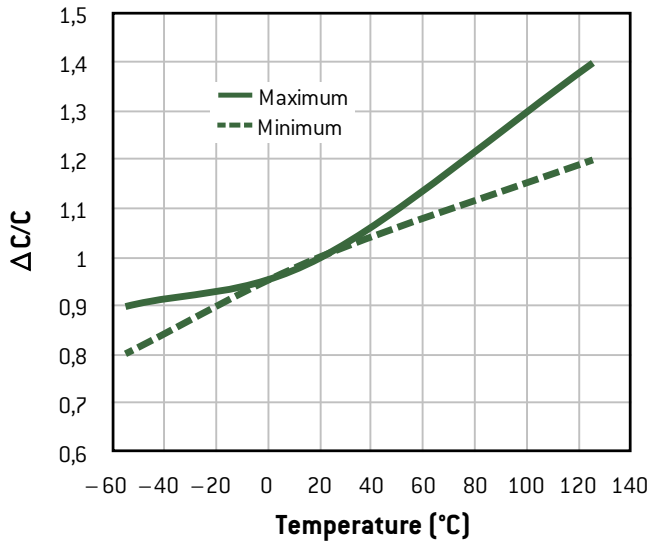

ESR CHANGE VS FREQUENCY

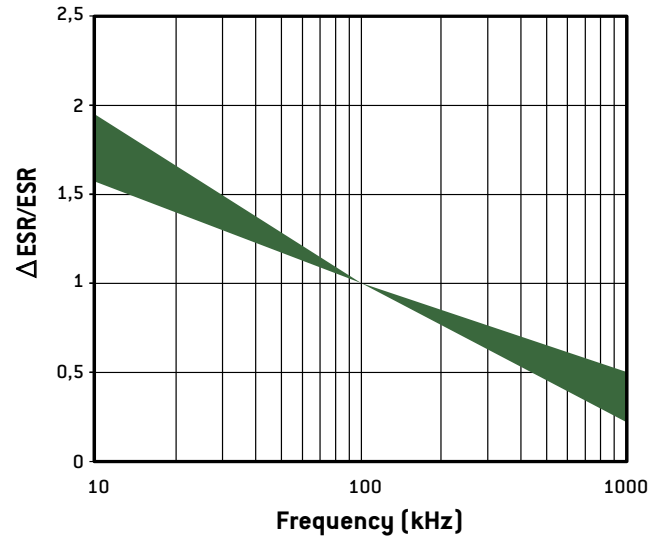

CTP21

Polymer tantalum capacitors
Very low ESR
 SMD
 Polarized



ELECTRICAL AND CLIMATIC CHARACTERISTICS

	CTP21
Operating temperature	-55°C +105°C
Damp heat	56 days
Capacitance range	47µF ⇒ 560µF
Tolerance	± 10% - ± 20%
Voltage range	16V ⇒ 75V
Max. capacitance change -55°C	-25%
Max. capacitance change +85°C	+15%
Max. capacitance change +105°C	+25%
Maximum DF at +20°C	see table
Maximum DF at -55°C	see table
Maximum DF at +85°C	1,2 x lim. 20°C
Maximum DF at +105°C	1,2 x lim. 20°C
Max. leakage current at +20°C	see table
Max. leakage current at +85°C	10 x lim. 20°C
Max. leakage current at +105°C	10 x lim. 20°C / U _c
Max. ESR at 100kHz +20°C	see table

DIMENSIONS (mm)

Case code	Dimensions					
	L ^{-0.1} _{+0.5}	W ^{-0.1} _{+0.5}	H ^{-0.1} _{+0.5}	T _W ^{-0.1} _{+0.5}	P	T
D	11	12,5	5,5	10,5	1,5	3

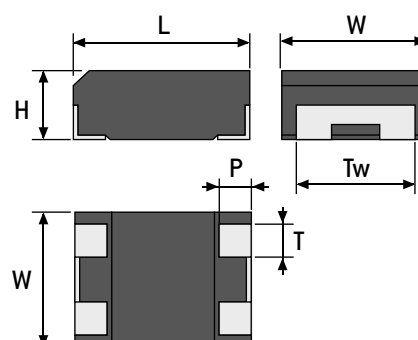

MARKING, PACKAGING, CONSTRUCTION:
 see general characteristics

HOW TO ORDER

Commercial description	Model	Case	Capacitance in µF	Tolerance in %	DC Voltage	Termination	Packaging
	CTP21	D	150µF	20%	40V	T	R
EXXELIA PN	Model code	Case	Capacitance code	Tolerance code	DC Voltage code	Termination	Packaging
	CTP21	D	157	M	040	T	R
			Expressed in pF with 3 digits: 2 digits for the value and the third for the multiplier	K = 10% M = 20%	Expressed in volt with 3 digits	Commercial description / EXXELIA PN T = SnPb (non RoHS) F = Sn100% (RoHS)	- = Bulk R = Tape & Reel

STANDARD RATINGS - ELECTRICAL CHARACTERISTICS

Capacitance 100Hz +20°C (μ F)	Case (code)	Type	Max. I leak			Max. DF 100Hz +20°C (%)	Max. DF 100Hz -55°C (%)	Max. DF 100Hz +85°C (%)	Max. DF 100Hz +105°C (%)	Max. ESR 100kHz +20°C (m Ω)	Irms Max. 100kHz +20°C (A)
			+20°C (μ A)	+85°C (μ A)	+105°C (μ A)						
Rated voltage (+85°C) 16 V - Category voltage (+105°C) 12 V											
390	D	CTP21	62,4	624	624	16	16	19,2	19,2	30	3,4
470	D	CTP21	75,2	752	752	16	16	19,2	19,2	30	3,5
560	D	CTP21	89,6	896	896	16	16	19,2	19,2	30	3,7
Rated voltage (+85°C) 25 V - Category voltage (+105°C) 20 V											
180	D	CTP21	45	450	450	12	12	14,4	14,4	40	2,5
270	D	CTP21	67,5	675	675	12	12	14,4	14,4	35	2,7
330	D	CTP21	82,5	825	825	12	12	14,4	14,4	35	2,9
Rated voltage (+85°C) 40 V - Category voltage (+105°C) 30 V											
68	D	CTP21	27,2	272	272	10	10	12	12	40	2,4
82	D	CTP21	32,8	328	328	10	10	12	12	40	2,5
100	D	CTP21	40	400	400	10	10	12	12	40	2,6
120	D	CTP21	48	480	480	10	10	12	12	35	2,7
150	D	CTP21	60,0	600	600	10	10	12	12	35	2,8
Rated voltage (+85°C) 50 V - Category voltage (+105°C) 40 V											
68	D	CTP21	34,0	340	340	10	10	12	12	50	2,3
Rated voltage (+85°C) 63 V - Category voltage (+105°C) 50 V											
33	D	CTP21	29,6	296	296	9	9	10	10	60	1,7
47	D	CTP21	29,6	296	296	9	9	10	10	60	1,9
56	D	CTP21	35,2	352	352	9	9	10	10	55	2,1
Rated voltage (+85°C) 75 V - Category voltage (+105°C) 60 V											
33	D	CTP21	24,7	247	247	9	9	10	10	60	1,8
47	D	CTP21	35,2	352	352	9	9	10	10	60	1,9

STANDARD TERMINATIONS:

- T tinning electrolytic SnPb (non RoHS)
- F tinning electrolytic 100% Sn (RoHS)

PACKAGING:

Standard: Bulk

Optional: Tape & Reel

When ordering add the suffix «R» just after the termination code.

CTP42

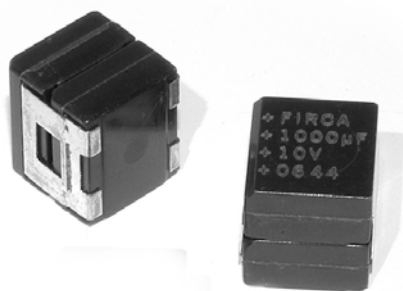

Polymer tantalum capacitors
 Ultra low ESR
 High capacitance
 SMD
 Polarized

ELECTRICAL AND CLIMATIC CHARACTERISTICS

	CTP42
Operating temperature	-55°C +105°C
Damp heat	56 days
Capacitance range	68µF ⇔ 1200µF
Tolerance	± 10% - ± 20%
Voltage range	16V ⇔ 75V
Max. capacitance change -55°C	-25%
Max. capacitance change +85°C	+15%
Max. capacitance change +105°C	+25%
Maximum DF at +20°C	see table
Maximum DF at -55°C	see table
Maximum DF at +85°C	1,2 x lim. 20°C
Maximum DF at +105°C	1,2 x lim. 20°C
Max. leakage current at +20°C	see table
Max. leakage current at +85°C	10 x lim. 20°C
Max. leakage current at +105°C	10 x lim. 20°C / U _c
Max. ESR at 100kHz +20°C	see table

DIMENSIONS (mm)

Case code	Dimensions (mm)					
	L ⁻¹ _{+0.5}	W ⁻¹ _{+0.5}	H ⁻¹ _{+0.5}	TW ⁻¹ _{+0.5}	P	T
D	12	12,5	11,5	10,5	1,5	3

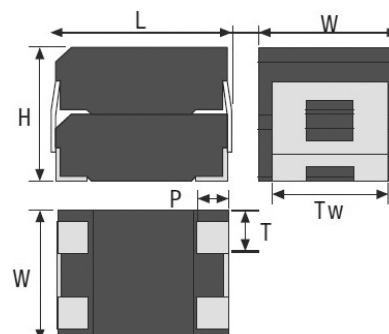

MARKING, PACKAGING, CONSTRUCTION:
 see general characteristics

HOW TO ORDER

Commercial description	Model	Case	Capacitance in µF	Tolerance in %	DC Voltage	Termination
	CTP42	D	150µF	20%	50V	S
EXXELIA PN	Model code	Case	Capacitance code	Tolerance code	DC Voltage code	Termination
	CTP42	D	157	M	050	S

Expressed in pF with 3 digits: 2 digits for the value and the third for the multiplier

K = 10%
M = 20%

Expressed in volt with 3 digits

Commercial description / EXXELIA PN
 S = hot solder dipped (non RoHS)
 F = hot solder dipped 100% Sn(RoHS)

STANDARD RATINGS - ELECTRICAL CHARACTERISTICS

Capacitance 100Hz +20°C (μ F)	Case (code)	Type	Max. Leakage Current			Max. Dissipation Factor				Max. ESR 100kHz +20°C (m Ω)	I _{rms} Max. 100kHz +20°C (A)
			+20°C (μ A)	+85°C (μ A)	+105°C (μ A)	100Hz +20°C (%)	100Hz -55°C (%)	100Hz +85°C (%)	100Hz +105°C (%)		
Rated voltage (+85°C) 16 V - Category voltage (+105°C) 12V											
1000	D	CTP42	160	1600	1600	16	16	19.2	19.2	15	6.7
1200	D	CTP42	192	1920	1920	16	16	19.2	19.2	15	7.2
Rated voltage (+85°C) 25 V - Category voltage (+105°C) 20 V											
540	D	CTP42	135	1350	1350	12	12	14.4	14.4	20	5.2
660	D	CTP42	165	1650	1650	10	10	12	12	20	5.6
Rated voltage (+85°C) 40V - Category voltage (+105°C) 30 V											
220	D	CTP42	88	880	880	10	10	12	12	25	5.0
330	D	CTP42	132	1320	1320	10	10	12	12	25	5.4
Rated voltage (+85°C) 50V - Category voltage (+105°C) 40 V											
150	D	CTP42	75	750	750	10	10	12	12	30	4.4
Rated voltage (+85°C) 63V - Category voltage (+105°C) 50 V											
100	D	CTP42	63	630	630	9	9	10	10	35	3.6
120	D	CTP42	75.6	756	756	9	9	10	10	35	4
Rated voltage (+85°C) 75V - Category voltage (+105°C) 60 V											
68	D	CTP42	51	510	510	9	9	10	10	35	3.4
100	D	CTP42	75	750	750	9	9	10	10	35	3.6

STANDARD TERMINATIONS:

- S hot solder dipped (non RoHS)
- F hot solder dipped 100% Sn (RoHS)

PACKAGING:

Standard: Bulk

Tape & Reel packaging (only CTP21)

As per IEC 286-3

TAPE DIMENSIONS (mm)

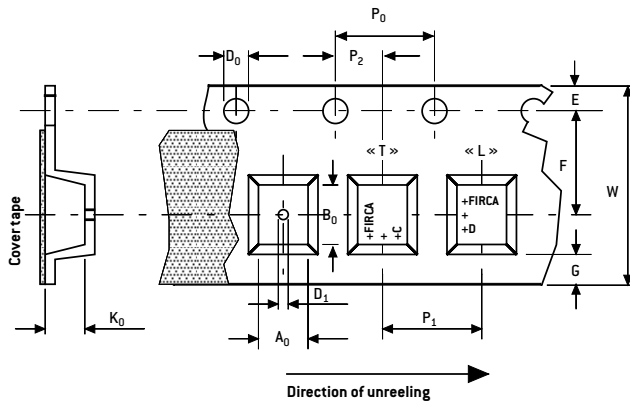

W ± 0,3	E ± 0,1	F ± 0,05	P ₀ ± 0,1	D ₀ + 0,1 - 0	D ₁ ± 0,1	G min.	P ₁ ± 0,1	P ₂ ± 0,05
24,0	1,75	11,5	4,0	1,5	1,5	0,75	16,0	2,0

Note: A₀ B₀ K₀ are defined by component size
 Reel diameter: 330 mm (nominal)
 Diameter of central hole: 12,8 mm

REEL CHARACTERISTICS

Case (code)	Tape width (mm)	Quantity per Reel (mm)	Position	Pitch
D	24,0	400	L	16,0

Note: The minimum quantity per reel is 50% of the above mentioned one

COMPONENT POSITION

T = Transversal (+ termination away from the sprocket hole)

L = Longitudinal (+ termination in the direction of unreeling)

SOLID TANTALUM MnO₂ CAPACITORS



Electrical characteristics

CAPACITANCE

The capacitance is defined by a rated value (C_R , indicated on the capacitor) and a tolerance (generally $\pm 20\%$).

The capacitance is measured for most of the types at a 100Hz frequency (1 kHz for CTS21 - CTS21E - CTC21 - CTC21E) under a 0,1 to 1 V_{AC} voltage and a 2,1 to 2,5 V bias.

At room temperature, it must be in the range defined by the rated value and the tolerance.

Capacitance change vs applied DC voltage: negligible

CAPACITANCE CHANGE VS FREQUENCY: STANDARD TYPES

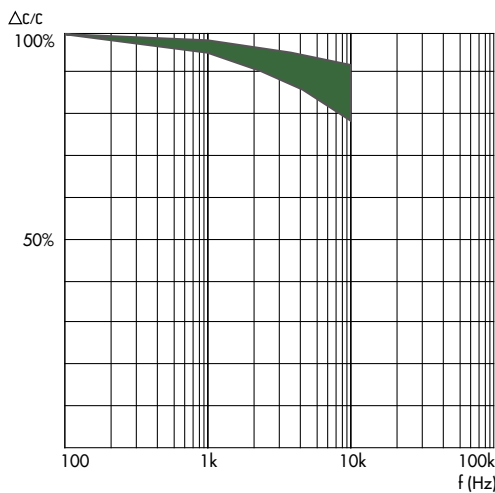

CAPACITANCE CHANGE VS TEMPERATURE: STANDARD TYPES

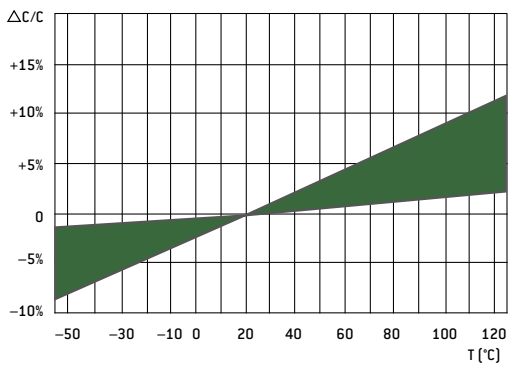

CAPACITANCE CHANGE VS FREQUENCY: CTC21 AND CTS21

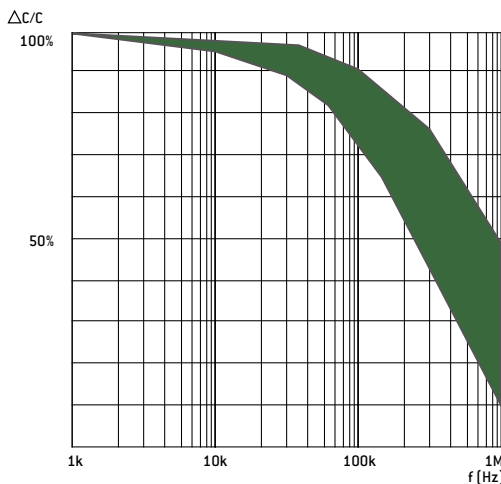

CAPACITANCE CHANGE VS TEMPERATURE: CTC21 AND CTS21

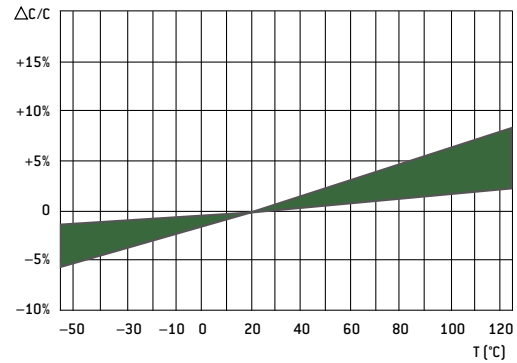

See typical curves below. Maximum changes are given, for each type, on the data sheets.

TOLERANCE (ON RATED CAPACITANCE)

It defines, with the rated capacitance, the range in which the capacitance value must be at room temperature

e.g.: Rated capacitance: 100 μF
 Tolerance: 20%
 The measured capacitance must be between:
 $100 - (20\% \text{ of } 100) = 80$ and $100 + (20\% \text{ of } 100) = 120$
 The standard tolerance for tantalum capacitors is 20%.

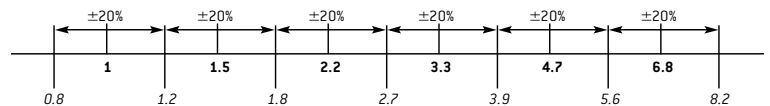

DIRECT DC VOLTAGE

The **rated voltage (U_R)**, indicated on the capacitor, is the maximum DC voltage which can be applied continuously between $-55^\circ C$ and $+85^\circ C$.

For the types which can be used up to $125^\circ C$, the voltage must be derated between $+85^\circ C$ and $+125^\circ C$ according to the following curve.

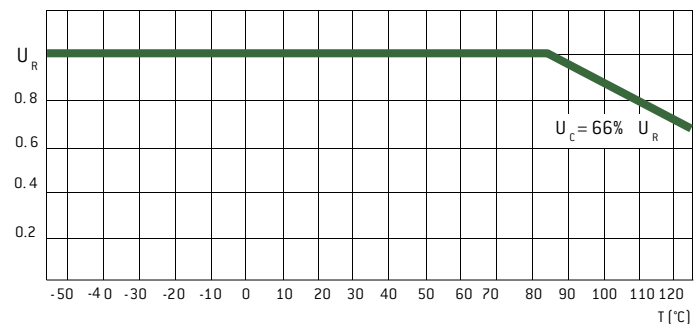

The **category voltage (U_C)** is consequently the maximum DC voltage which can be applied continuously at $+125^\circ C$.

The **surge voltage** is the maximum voltage which can be applied for short periods.

It is given for each type in the data sheet and is generally equal to 1,3 times U_R between $-55^\circ C$ and $+85^\circ C$ and 1,3 times U_C at $+125^\circ C$.

Tests are performed with charging periods of 30 seconds, through a 1000 Ω resistor, and discharging periods of 5 min 30 s. 1000 cycles are done.

Electrical characteristics

REVERSE VOLTAGE

This characteristic is not guaranteed for all types (see data sheets).

MAXIMUM REVERSE VOLTAGE IS GENERALLY:

- 0,15 times U_R at +20°C
- 0,05 times U_R at +85°C
- 0,01 times U_R at +125°C

TESTS ARE PERFORMED WITH THE FOLLOWING CONDITIONS:

125 hours under Reverse voltage followed by 125 hours under direct voltage.

LEAKAGE CURRENT

Leakage current is the residual current which flows through the capacitor after the charging time, under rated voltage. It is measured after a time not exceeding 5 minutes and is given in μA.

It is equivalent to the insulation resistance of the capacitor and it must be as low as possible.

Maximum leakage current is a function of capacitance and rated voltage values and is given, for each type, in the data sheets.

AT 20°C, THE LIMIT IS GENERALLY:

Lc Max. (μA) = 0,01 x C_R x U_R with C_R in μF and U_R in V.

LEAKAGE CURRENT CHANGE VS APPLIED VOLTAGE

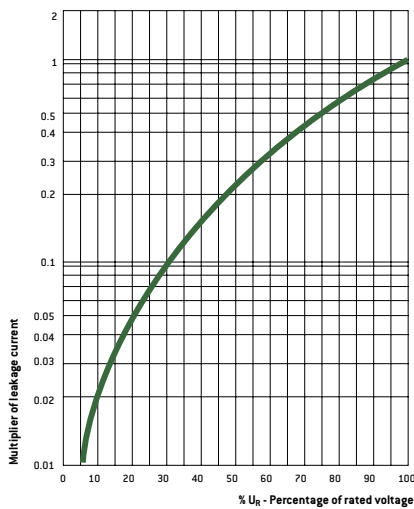

LEAKAGE CURRENT CHANGE VS TEMPERATURE

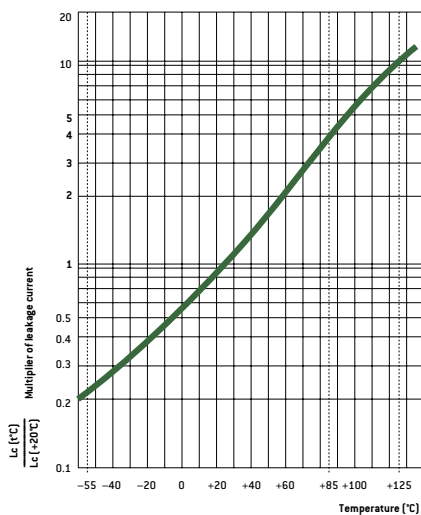

DISSIPATION FACTOR

Dissipation factor is generally measured at the same time as the capacitance (at 100Hz or 1kHz depending on the model), with the same conditions. It is a function of the series resistance of the capacitor and the capacitance at low frequency.

$$DF = ESR \times C \times 2 \pi f$$

At low frequency, the series resistance is the sum of an ohmic part (leads, contacts, MnO₂) and the dielectric losses.

Dissipation factor is given in % and maximum limits are given for each type in the data sheets.

DISSIPATION FACTOR CHANGE VS TEMPERATURE

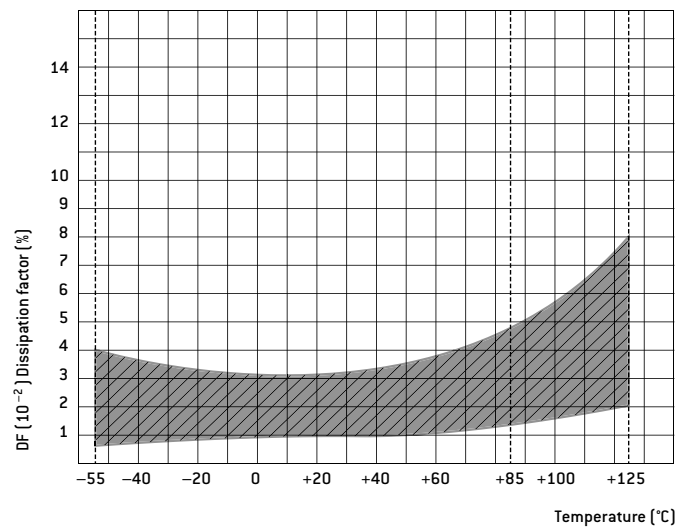

DISSIPATION FACTOR CHANGE VS FREQUENCY

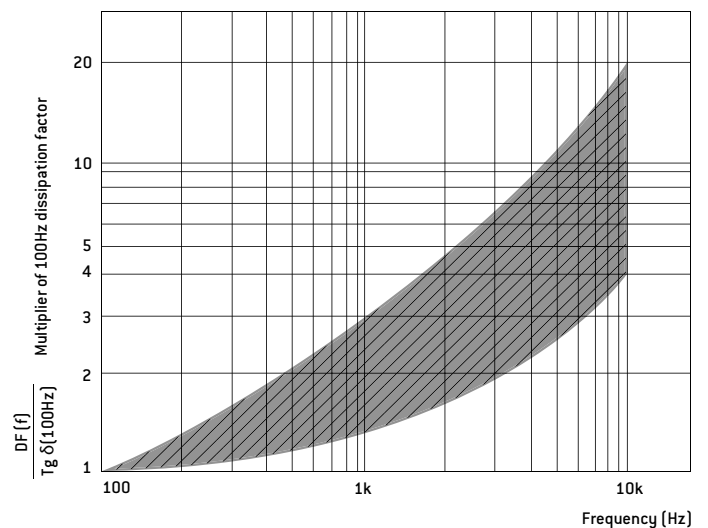

Electrical characteristics

EQUIVALENT SERIES RESISTANCE OR IMPEDANCE

Equivalent circuit of a capacitor

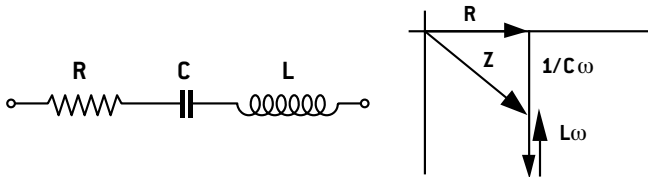

- R:** equivalent series resistance of the capacitor (leads, contacts, MnO₂, dielectric losses)
- L:** inductance mainly due to the leads
- C:** capacitance

Equivalent Series Resistance for

CTS21	CTC21	CTC4	CTS41ESR	CTC42	CTP21
CTS21E	CTC21E	CTC4 RSE		CTC42E	CTP42

For these types which are specially designed to be used in power supplies and converters, a maximum ESR is given at a frequency of 100kHz or 500 kHz. Parameters such output ripple voltage and ripple current capability are directly a function of the ESR value.

Maximum ESR: see data sheets.

Impedance (for standard products)

For the others types, a maximum limit is given for the impedance. The formula for impedance is:

$$Z = \sqrt{R^2 + (L\omega - 1/C\omega)^2}$$

Examples of impedance curves vs frequency are given in the following pages.

It can be seen that:

- at low frequencies, impedance is a function of capacitance
- at high frequencies, impedance is a function of inductance
- at medium frequencies, it is a function of the ESR

Maximum impedance: see data sheets.

ESR CHANGE VS TEMPERATURE

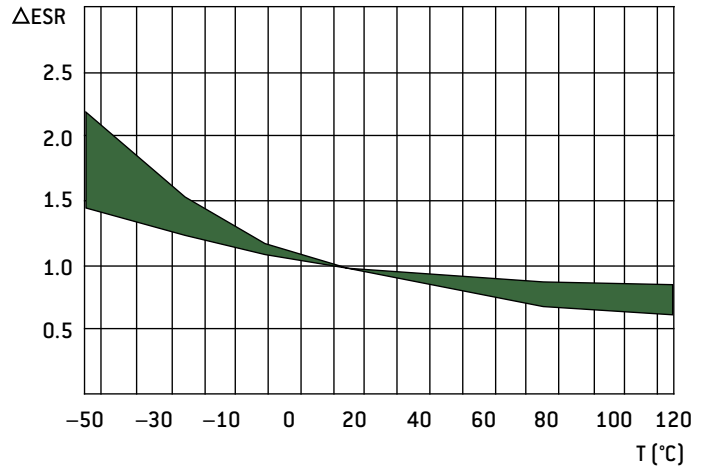

ESR CHANGE VS FREQUENCY

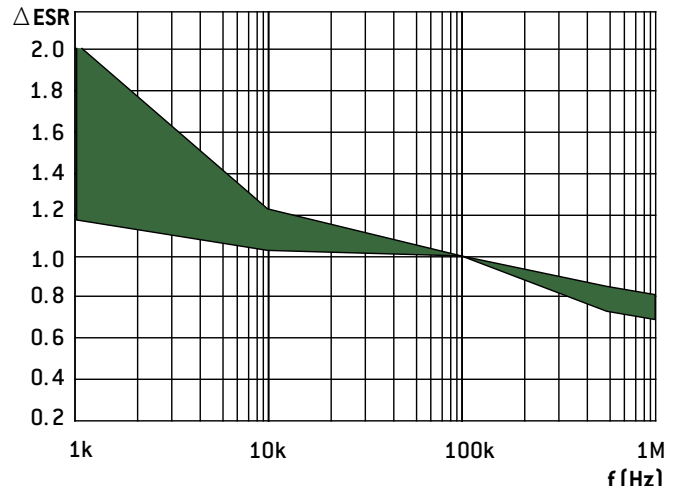

Electrical characteristics

CTS1 TYPE

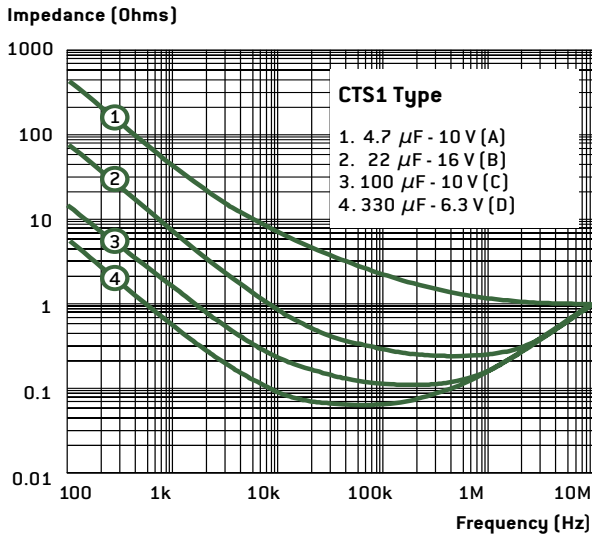

CTS27 TYPE

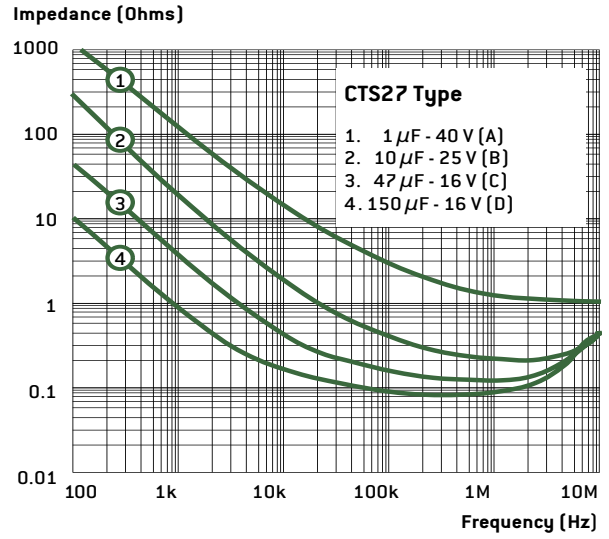

CTS4 TYPE

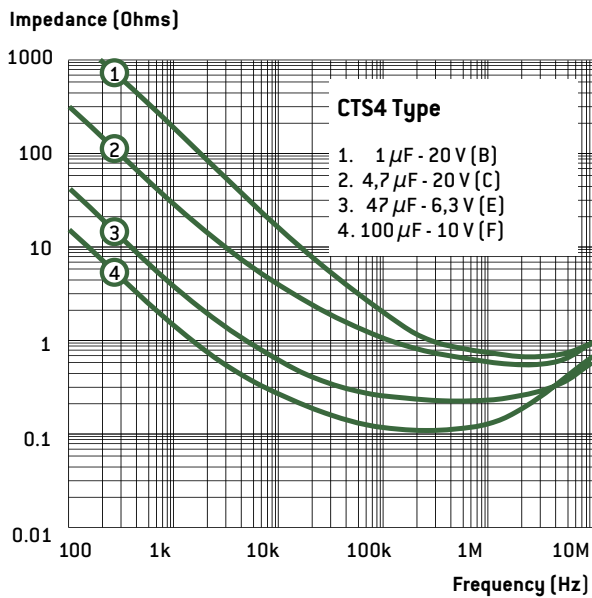

CTC3 TYPE

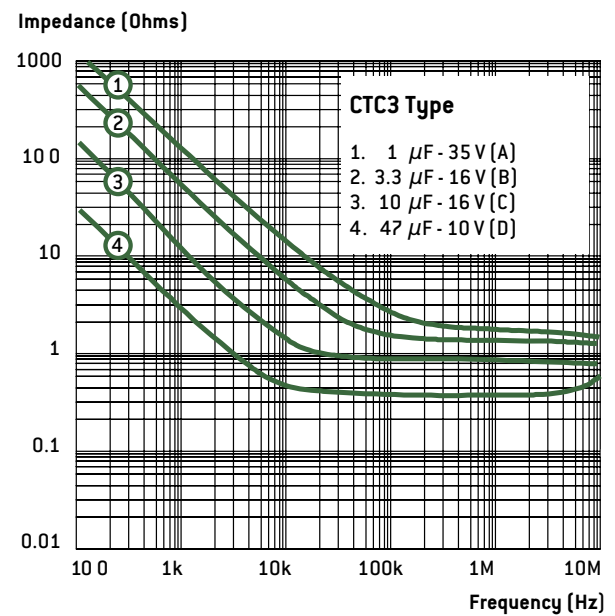

CTS21 TYPE CASE C

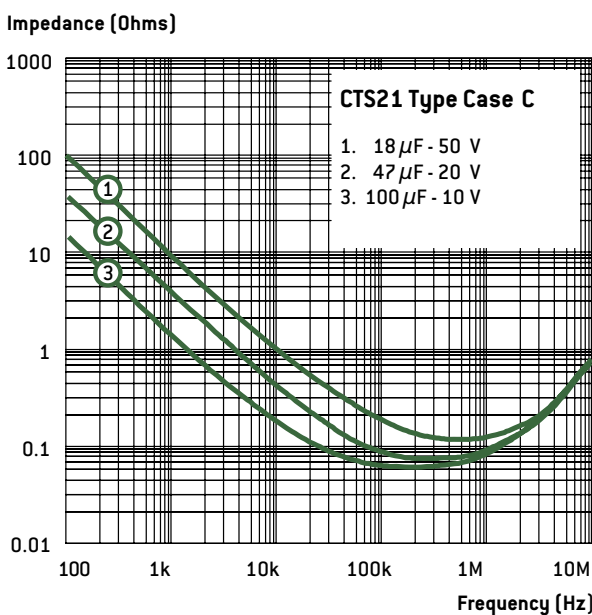

CTS21 TYPE CASE D

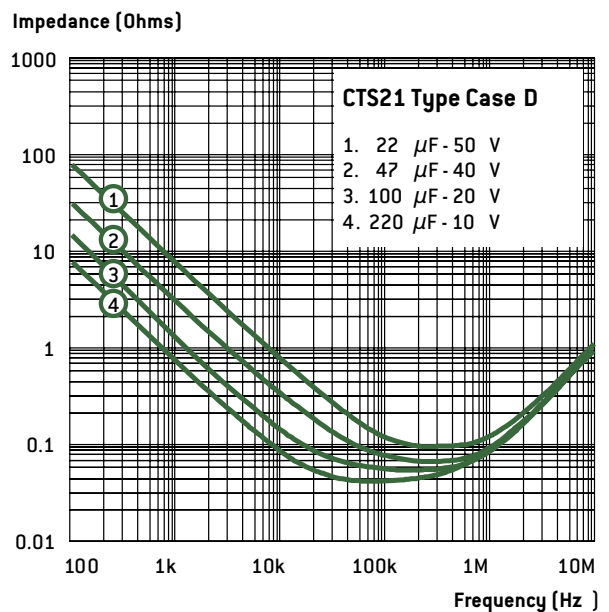

Electrical characteristics

CTS21E TYPE CASE C

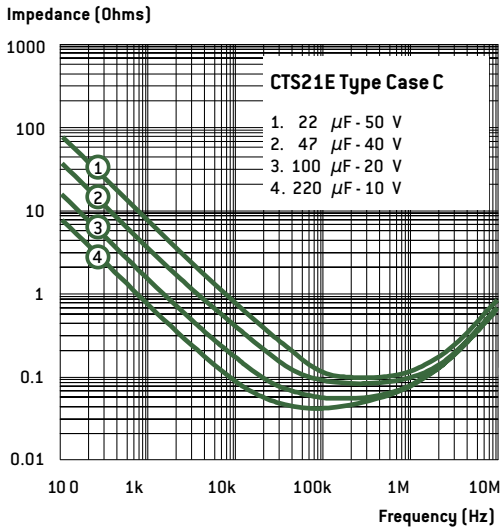

CTS21E TYPE CASE D

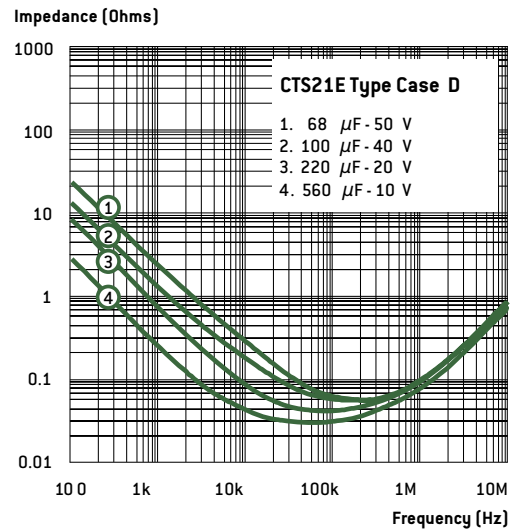

CTC21 TYPE CASE C

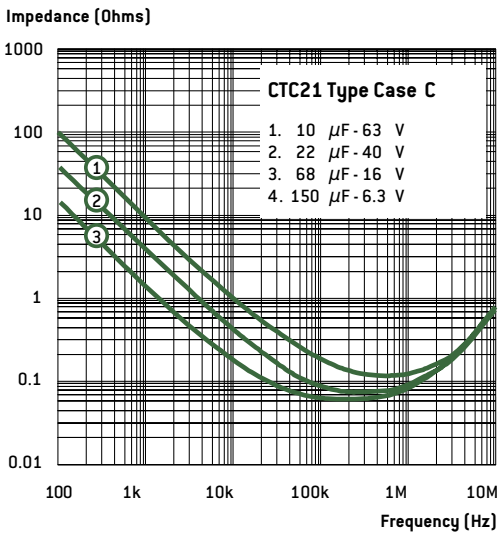

CTC21 TYPE CASE D

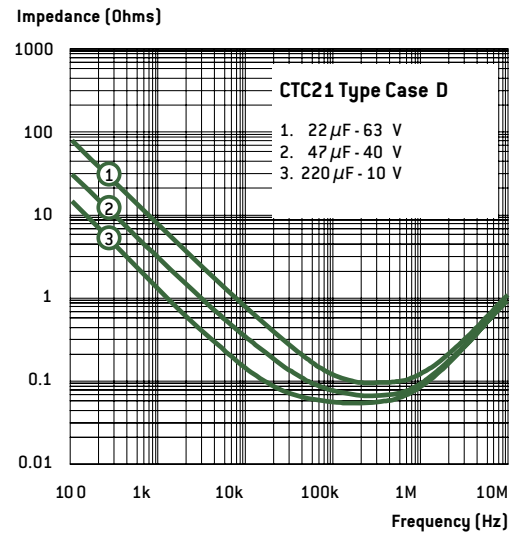

CTC21E TYPE CASE C

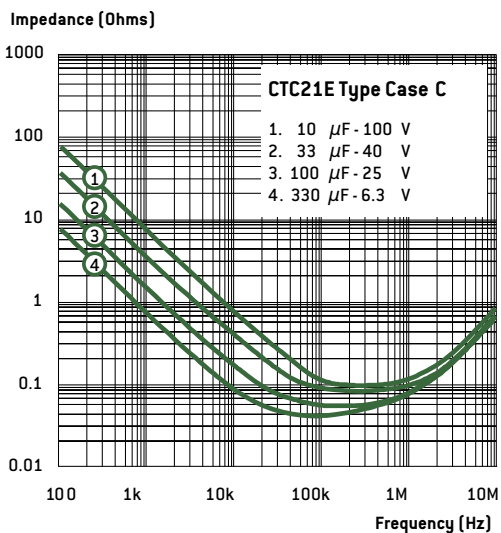

CTC21E TYPE CASE D

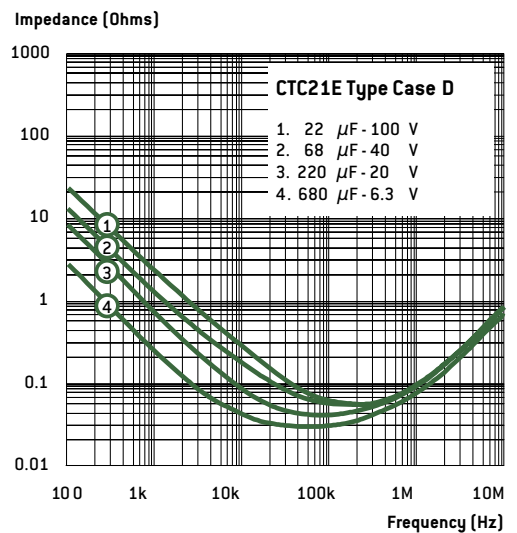

Electrical characteristics

MAXIMUM RIPPLE CURRENT - MAXIMUM RIPPLE VOLTAGE

The maximum value of the ripple current, or ripple voltage which can be applied to the capacitor is only limited by the thermal effect. Indeed, as the electrolyte is in this case a solid semi-conductor, there is no damage and physical change in the structure when a ripple current is flowing through it.

On the other hand, as the series resistance is not zero, there will be a heating which is proportional to the ESR and to the square of ripple current [$P = ESR \times I_{rms}^2$]

Types

CTS21	CTC21	CTC4	CTS41 RSE	CTC42	SMT47
CTS21E	CTC21E	CTC4 RSE		CTC42E	

For these products, for which a maximum ESR is given, the maximum ripple current is also given in the data sheets. This value has been calculated with the maximum ESR values and a maximum dissipated power per case size.

As the ESR changes in frequency, maximum ripple currents are given for two frequencies (1kHz and 100kHz). For other frequencies, apply the rule given by the curve below.

COEFFICIENT APPLY TO THE MAXIMUM RIPPLE CURRENT VS TEMPERATURE

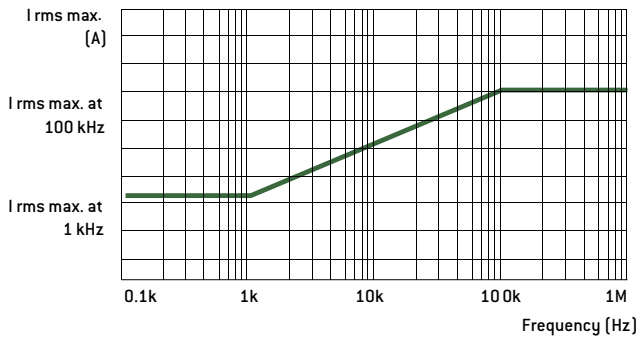

As there is heating due to the ripple current, it is also necessary to derate the maximum ripple current when the room temperature is higher than 20°C:

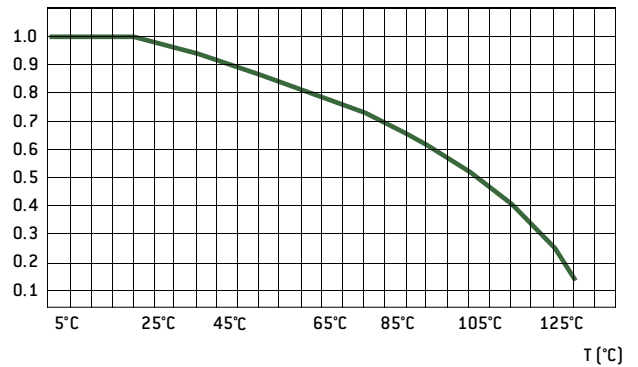

TYPICAL HEATING OF THE CASE VS DISIPATED POWER

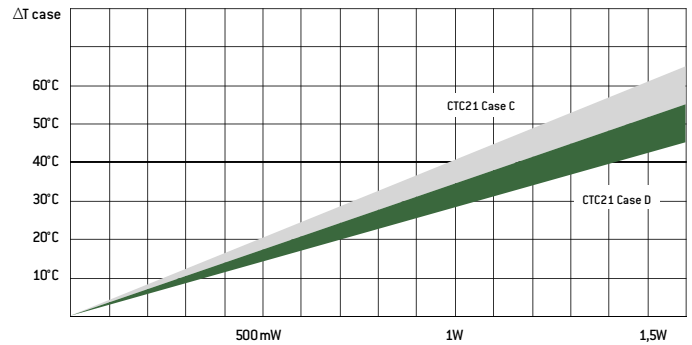

Electrical characteristics

OTHERS TYPES

The same rule will be used to calculate the maximum ripple voltage:

$$I_{rms\ Max.} = \sqrt{(P_{max}/ESR_{max})}$$

MAXIMUM DISSIPATED POWER WILL BE CHOSEN AS FOLLOW:

Metal cases (CTS1, CTS13, CTS23, CTS33, ...)

- case A : 0,090 W
- case B : 0,100 W
- case C : 0,125 W
- case D : 0,180 W

Plastic cases (CTS27)

- case A : 0,080 W
- case B : 0,090 W
- case C : 0,100 W
- case D : 0,125 W

SMD cases (CTC3, CTC3E, ...)

- case A : 0,075 W
- case B : 0,085 W
- case C : 0,110 W
- case D : 0,150 W
- case S : 0,060 W
- case T : 0,070 W
- case U : 0,090 W
- case V : 0,0125 W

These values should be derated at elevated temperature as follows

- at +85°C: 0,9
- at +125°C: 0,4

For maximum values of ESR, it will be possible to use the maximum impedance value given at 100kHz or to measure the ESR of capacitors.

Maximum ripple voltage can be calculated with the value of maximum ripple current and the following formula

$$U_{rms} = Z \text{ [impedance]} \times I_{rms}$$

NOTE FOR ALL TYPES

In addition to the requirements due to thermal effects, maximum ripple currents and voltages will be limited by the following parameters:

- the sum of DC voltage and positive peak of AC voltage must be less than maximum allowable direct voltage of the capacitor.
- the negative peak of AC voltage will not create a voltage exceeding maximum allowable Reverse voltage.

9 - CHARGE DISCHARGE / SURGE CURRENT

For standard types of solid tantalum capacitors, it is necessary to limit the surge current by placing a resistance in series with the capacitor. The value of this resistance will be calculated by using the rule of 3Ω per volt (I_{Max.} = 0,33 A).

However, some more recent types can be used without any limit on the surge current; these types are registered with the reference «high surge current» (eg : CTS32, CTS23, CTS33, CTS21, CTS21E, CTS41, CTS41ESR, CTC4, CTC4 RSE, CTC21, CTC21E, CTC42, CTC42E, SMT47).

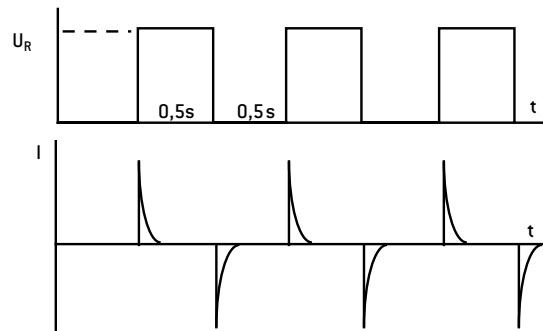
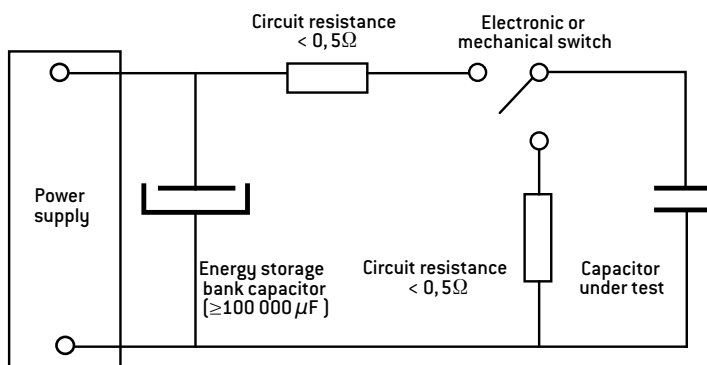

The high surge current test is performed to check that these capacitors can be used in low impedance circuits, and to make sure of their capability to withstand high surge currents.

The test being performed under rated voltage with a maximum 0,5 Ω circuit resistance, the peak surge current will be a minimum equal to $I_p = U_R / 0,5$ (if the ESR of the capacitor is considered as negligible).

e.g.: high surge current test performed on a CTS21 100μF-20 V (ESR=75mΩ, negligible compared to 0,5Ω) Surge current = $20/0,5 = 40$ A during a few tens of μs.

Depending upon the types, this test can be 100% performed or on a sampling basis, during 3 to 5 cycles. During periodic tests, 1 million cycles are performed.

General characteristics

CLIMACTIC CHARACTERISTICS

1- CLIMATIC CATEGORY

Climatic category defines the temperature range over which the capacitor can be used continuously, and also the number of days for the damp heat test (this test is performed periodically at 40°C with a 93% moisture rate).

Note: for types with a climatic range of -55°C to +125°C, it is necessary to derate the voltage for temperatures higher than 85°C (see page 84).

2- THERMAL SHOCKS - RAPID CHANGES OF TEMPERATURE

This test is performed to check that the capacitors can withstand sudden temperature changes. The method which is used is the one with two chambers, one at -55°C, the other one at +85°C or +125°C, depending upon the types. Five cycles are performed, with 30 min at low temperature and 30 min at high temperature, during the periodic tests or on 100% of the batch. Electrical characteristics are measured after this test.

3 - DAMP HEAT TEST

This test is performed during the periodical test, with the following conditions:

Temperature: 40°C	DC voltage: without
Humidity: 90 to 95%	Time: 21 or 56 days

Electrical characteristics are measured after this test.

MECHANICAL CHARACTERISTICS

1 - VIBRATIONS

This test is performed during the periodical test, with the following conditions:

Metal cases

- Method B4
- Frequency: 10 to 2000Hz
- Amplitude: 1,5 mm or 196 m/s²
- Time: 6 hours

Plastic cases: CTS4 or CTS41 Type

Same conditions, except:

- Amplitude 0,75 mm or 98 m/s²

Plastic cases: CTS27 Type

Same conditions, except:

- Frequency: 10 to 55Hz
- Amplitude: 1,5 mm or 98 m/s²

2 - SHOCKS

This test is performed just after the vibrations test, with the following conditions for all types:

- Acceleration: 981 m/s²
- Pulse width: 6 ms
- Shape: 1/2 sinewave
- Number of shocks: 3 for each of the 3 directions

RELIABILITY - LIFE TIME

1 - RELIABILITY

Reliability of a component can be defined as its probability to work without any failure, in defined conditions and during a fixed time.

Reliability is not therefore only a function of the component quality, but also of the application and environmental conditions.

The parameter which is the most commonly used for the reliability is the failure rate in time, generally expressed in % per 1000 hours.

1-1 ESTABLISHED FAILURE RATE CAPACITORS (CTS1M)

This types, equivalent to MIL types, can be supplied with a fixed failure rate. This failure rate is coded with the following letters:

M = 1.0 % / 1000 h
P = B = 0.1% / 1000 h
R = C = 0.01% / 1000 h
S = D = 0.001% / 1000 h

For EXXELIA, the rate is calculated by recording the failures during the burn-in and according to the Weibull method.

The desired failure rate code letter must be added just after the type reference (ie: CTS1MC = CTS1M with a failure rate of 0.01% / 1000 hours).

1-2 CALCULATION OF A COMPONENT FAILURE RATE USED IN AN EQUIPMENT

The calculation method on the next page uses parameters which are given by the CNET (Centre National d'Étude des Télécommunications) in its Reliability Data Book (RDF 1993).

The failure rate is calculated with parameters which are function of the capacitor (capacitance, case type, approvals, high surge current test) and others ones which are representative of application conditions (voltage, temperature, resistance in series, environmental conditions).

Example: CTS21E 150µF-25 V used under 12 volts, at 40°C, without serie resistance, in a satellite in orbit:

$$\pi_t = 1,2 \quad \pi_v = 1,38 \quad \pi_R = 1 \quad \pi_B = 1$$

$$\pi_C = 1,8 \quad \pi_E = 0,5 \quad \pi_q = 1$$

$$\lambda = 4 \times 1,2 \times 1,38 \times 1 \times 1 \times 1,8 \times 0,5 \times 1 \cdot 10^{-9}/h$$

$$= 6 \cdot 10^{-9}/h = 0,0006 \% \text{ defect}/1000 \text{ hours}$$

2 - LIFE TIME

There is no known damaging mechanism in time for solid tantalum capacitors; that is why it is difficult to give a precise life time.

However, life tests at 85°C under rated voltage and 125°C under derated voltage are periodically performed.

In addition, during qualification programs for new types, life test at 85°C and 125°C have been performed during 10000 hours and no significant parameter change have been observed.

General characteristics

π_t = TEMPERATURE INFLUENCE

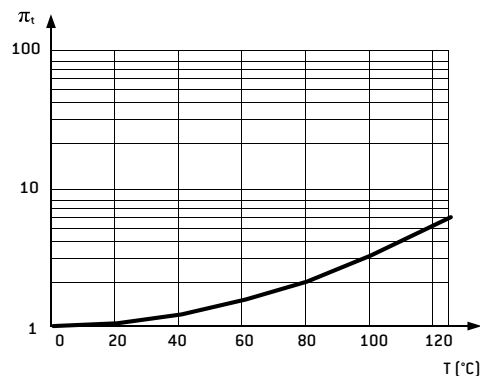

Formula: $\pi_t = \exp [1,8 \cdot (t / t_m)^2]$

with: t = using temperature
t_m = maximum temperature
Curve for t_m = 125°C

π_v = INFLUENCE OF APPLIED VOLTAGE VS RATED VOLTAGE

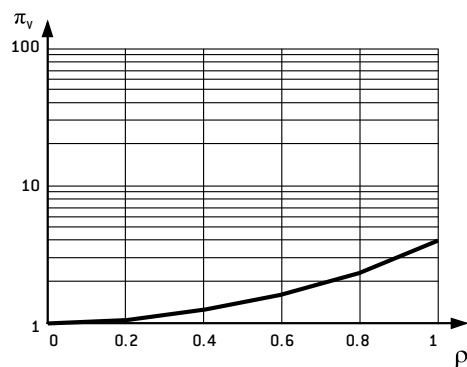

Formula: $\pi_v = \exp [(\rho / 0,85)^2]$

$\rho = \frac{\text{peak voltage}}{\text{rated voltage}}$

Curve $\pi_v = f(\rho)$

π_R = INFLUENCE OF CIRCUIT RESISTOR IN SERIE

V = using voltage

R = circuit resistance between capacitor and power supply

1. Types with high surge current test: $\pi_R = 1$

2. Others types: π_R = function of R/V in /V

R/V ≥ 3	$\pi_R = 1$	R/V = 0,6	$\pi_R = 6$
R/V = 2	$\pi_R = 1,5$	R/V = 0,4	$\pi_R = 9$
R/V = 1	$\pi_R = 3$	R/V = 0,2	$\pi_R = 12$
R/V = 0,8	$\pi_R = 4,5$	R/V = 0,1	$\pi_R = 15$

π_E = INFLUENCE OF APPLICATION

Satellite in orbit	$\pi_E = 0,5$
Ground; stationary; protected	$\pi_E = 1$
Ground; stationary; non protected	$\pi_E = 2,5$
Ground; mobile; soft conditions	$\pi_E = 4$
Aircraft; soft conditions	$\pi_E = 4$
Ship; soft conditions	$\pi_E = 4$
Ground; mobile; hard conditions	$\pi_E = 5,5$
Ship; hard conditions	$\pi_E = 7$
Aircraft; hard conditions	$\pi_E = 10$
Satellite launching	$\pi_E = 12$

π_B = INFLUENCE OF CASE TYPE

Metal case	$\pi_B = 1$
Molded case	$\pi_B = 3$
Dipped	$\pi_B = 5$

π_C = INFLUENCE OF CAPACITANCE

0,1μF	$\pi_C = 0,75$
150μF	$\pi_C = 1,8$
330μF	$\pi_C = 2$
1000μF	$\pi_C = 3$

π_q = INFLUENCE OF QUALIFICATION

Products approved to CECC	$\pi_q = 1$
Others products	$\pi_q = 1$

Axial leads - General characteristics

Applicable for types see below:

General purpose: CTS1, CTS13, CTS32, CTS1M

Extended ranges: CTS23, CTS33

Special for power supplies and converters: CTS21, CTS21E

CONSTRUCTION

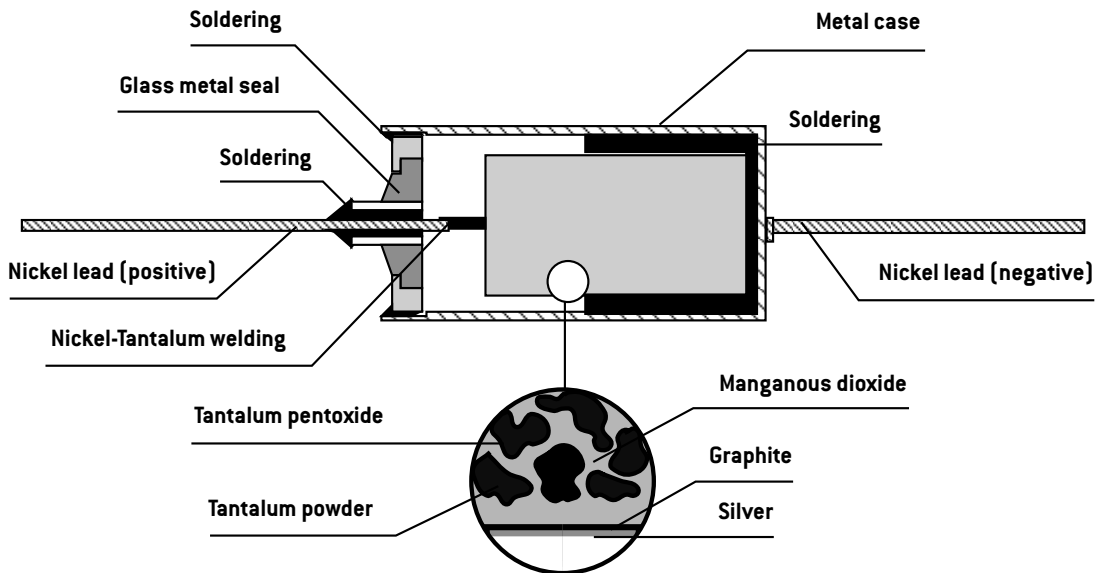

MARKING

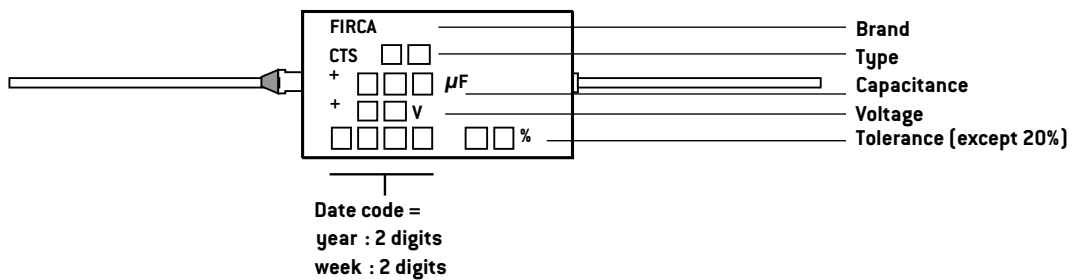

PACKAGING

Depending upon the quantities, there will be different types for packaging:

- Loose in plastic bags or boxes
- Taped in plastic bags
- Taped on reel

Dimensions about taping and reels are given on the next page.

Axial leads - Tape & Reel Packaging

LENGTH OF THE CAPACITOR

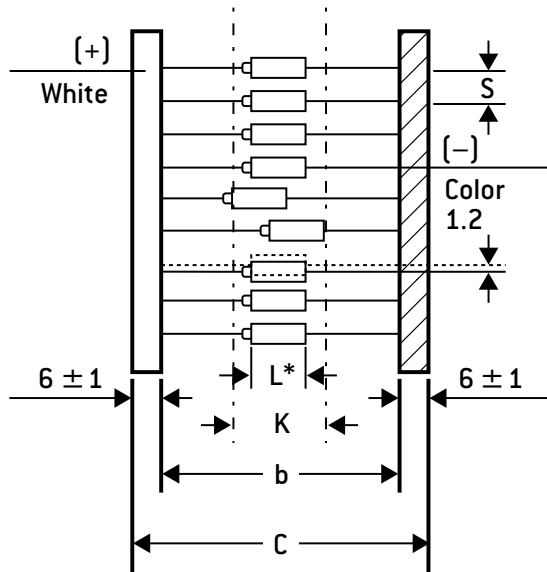

TAPE DIMENSIONS (in mm)

Case code	L max.	K max.	* $b \pm 2$	C max.	** $S \pm 0,5$	Qty per reel Std./max.
A	8,1	9,5	53	70	5	3500
B	12,8	14,2	53	70	5	2500
C	18,2	18,2	73	90	10	500
D	20,8	20,8	73	90	10	400

* The size b of 53 mm for B case is the standard dimension.

** Max. cumulative tolerance on 10 capacitors: ± 2 mm

REEL SIZE (in mm)

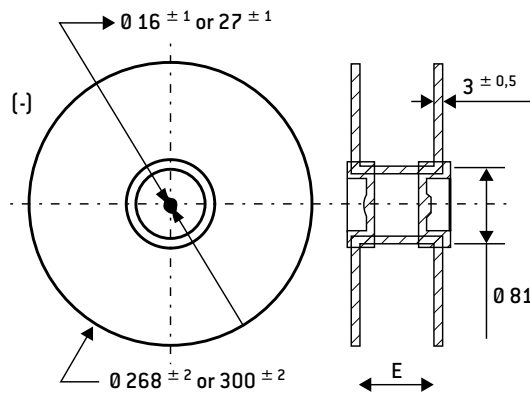

Size E of reels according to case sizes.

EA = 67

B = 67

C-D = 87

CTS1 - CTS13 CTS32 - CTS1M

Solid tantalum MnO₂ capacitors
Hermetically sealed metal cases
Axial leads
General purpose - Standard range
Polarized



ELECTRICAL AND CLIMATIC CHARACTERISTICS

	CTS1	CTS13	CTS32	CTS1M
Detail specification	CECC 30201-001 CECC 30201-002 CECC 30201-801	CECC 30201-005	CECC 30201-019	According to MIL-PRF-39003/01
Operating temperature	-55°C +125°C	-55°C +85°C	-55°C +125°C	-55°C +125°C
Damp heat	56 days	56 days	56 days	56 days
Capacitance range	0,1μF ⇒ 330μF	0,1μF ⇒ 330μF	1μF ⇒ 330μF	0,1μF ⇒ 330μF
Tolerance	±10% - ±20%	±10% - ±20%	±10% - ±20%	±10% - ±20%
Voltage range	6,3V ⇒ 125V	6,3V ⇒ 63V	6,3V ⇒ 63V	6,3V ⇒ 100V
Max. capacitance change -55°C	-10%	-10%	-10%	-10%
Max. capacitance change +85°C	+12%	+12%	+12%	+8%
Max. capacitance change +125°C	+15%	-	+15%	+12%
Maximum DF at +20°C	see table	see table	see table	see table
Maximum DF at -55°C	1,5 x lim20°C	1,5 x lim20°C	1,5 x lim20°C	= lim20°C
Maximum DF at +85°C	1,5 x lim20°C	1,5 x lim20°C	1,5 x lim20°C	= lim20°C
Maximum DF at +125°C	2,0 x lim20°C		2,0 x lim20°C	= lim20°C
Max. leakage current at +20°C	see table	see table	see table	see table
Max. leakage current at +85°C	0,1 x C _R U _R	0,1 x C _R U _R	0,1 x C _R U _R	20 x lim 20°C
Max. leakage current at +125°C	0,125 x C _R U _R	-	0,125 x C _R U _R	25 x lim 20°C
Max. impedance (20°C): case A	10 Ω	10 Ω	10 Ω	10 Ω
Max. impedance (20°C): case B	5 Ω	5 Ω	5 Ω	5 Ω
Max. impedance (20°C): case C	2 Ω	2 Ω	2 Ω	2 Ω
Max. impedance (20°C): case D	1 Ω	1 Ω	1 Ω	1 Ω
High surge current	no	no	1 million cycles	3 cycles-100%
Max. Reverse voltage at +20°C	-	-	15 % U _R	15 % U _R
Max. Reverse voltage at +85°C	-	-	5 % U _R	5 % U _R
Max. Reverse voltage at +125°C	-	-	1 % U _R	1 % U _R
Max. surge voltage at +85°C	1,3 x U _R	1,3 x U _R	1,3 x U _R	1,3 x U _R
Max. surge voltage at +125°C	1,3 x U _C	-	1,3 x U _C	1,3 x U _C

DIMENSIONS (mm)

Case code	Dimensions with insulating sleeve			
	Lt max	L max	D max	d +10% / -0,05
A	10,2	8,1	3,6	0,5
B	15,0	12,8	4,9	0,5
C	20,5	18,2	7,5	0,6
D	24,0	20,8	9,1	0,6

MARKING, PACKAGING, CONSTRUCTION:
see general characteristics

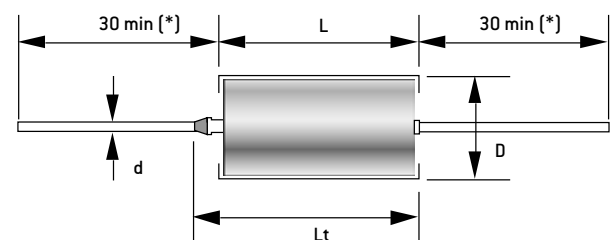

(*) 23mm for capacitors delivered on tape

HOW TO ORDER

Commercial description	Model				Case	Capacitance in μF	Tolerance in %	DC Voltage	Termination
	CTS1	CTS13	CTS32	CTS1M					
					D	150μF	20%	16V	H
EXXELIA PN	Model code				Case	Capacitance code	Tolerance code	DC Voltage code	Termination
	TS01	TS13	TS32	TS01M	D	157	M	016	A

Expressed in pF with 3 digits:
2 digits for the value
and the third for the multiplier

K = 10%
M = 20%

Expressed in volt
with 3 digits

Commercial description
H = SnPb (non RoHS)
- = Sn100% (RoHS)

EXXELIA PN
A = SnPb (non RoHS)
F = Sn100% (RoHS)

CTS1 - CTS13 CTS32 - CTS1M

STANDARD RATINGS - ELECTRICAL CHARACTERISTICS

Capacitance 100Hz +20°C [μF]	Case (code)	Type			Max. leakage current			Max. DF +20°C [%]	Type	Max. leakage current			Max. DF. +25°C [%]
					+20°C [μA]	+85°C [μA]	+125°C [μA]			+25°C [μA]	+85°C [μA]	+125°C [μA]	
Rated voltage (+85°C) 6,3 V (6 V for CTS1M) - Category voltage (+125°C) 4 V													
5,6	A	CTS1	CTS13	CTS32	1	3,5	4,4	6	CTS1M	0,3	6	7,5	4
6,8	A	CTS1	CTS13	CTS32	1	4,2	5,3	6	CTS1M	0,3	6	7,5	6
47	B	CTS1	CTS13	CTS32	2,9	29	36	6	CTS1M	1,5	24	30	6
56	B	CTS1	CTS13	CTS32	3,5	35	44	6	CTS1M	1,5	24	30	6
120	C			CTS32	7,5	75	94	6					
150	C	CTS1	CTS13	CTS32	9,4	94	117	6	CTS1M	4,5	90	113	8
180	C	CTS1	CTS13	CTS32	11,3	113	141	6	CTS1M	5,5	110	138	8
270	D	CTS1	CTS13	CTS32	17	170	212	6	CTS1M	6,5	130	163	8
330	D	CTS1	CTS13	CTS32	20,8	208	260	8	CTS1M	7,5	150	188	8
Rated voltage (+85°C) 10 V - Category voltage (+125°C) 6,3 V													
3,9	A	CTS1	CTS13	CTS32	1	3,9	4,8	6	CTS1M	0,3	6	7,5	4
4,7	A	CTS1	CTS13	CTS32	1	4,7	5,8	6	CTS1M	0,4	7	8,8	4
27	B	CTS1	CTS13	CTS32	2,7	27	34	6	CTS1M	2	40	50	6
33	B	CTS1	CTS13	CTS32	3,3	33	41	6	CTS1M	2,5	50	63	6
39	B	CTS1	CTS13	CTS32	3,9	39	49	6	CTS1M	2,5	50	63	6
82	C	CTS1	CTS13	CTS32	8,2	82	102	6	CTS1M	4	80	100	6
100	C	CTS1	CTS13	CTS32	10	100	125	6	CTS1M	5	100	125	8
120	C	CTS1	CTS13		12	120	150	6	CTS1M	6	120	150	8
180	D	CTS1	CTS13	CTS32	18	180	225	6	CTS1M	9	180	226	8
220	D	CTS1	CTS13	CTS32	22	220	275	8	CTS1M	10	200	250	8
Rated voltage (+85°C) 16 V (15 V for CTS1M) - Category voltage (+125°C) 10 V													
1,8	A	CTS1		CTS32	1	2,8	3,6	6					
2,2	A	CTS1		CTS32	1	3,5	4,4	6					
2,7	A	CTS1	CTS13	CTS32	1	4,3	5,4	6	CTS1M	0,3	6	7,5	4
3,3	A	CTS1	CTS13	CTS32	1	5,2	6,6	6	CTS1M	0,4	8	10	4
12	B	CTS1		CTS32	1,9	19	24	6					
15	B	CTS1		CTS32	2,4	24	30	6					
18	B	CTS1	CTS13	CTS32	2,8	28	35	6	CTS1M	2	35	44	6
22	B	CTS1	CTS13	CTS32	3,5	35	43,7	6	CTS1M	2	40	50	6
39	C	CTS1		CTS32	6,2	62	77,5	6					
47	C	CTS1		CTS32	7,5	75	93,7	6					
56	C	CTS1	CTS13	CTS32	8,9	89	111	6	CTS1M	4	80	100	6
68	C	CTS1	CTS13	CTS32	10,8	108	135	6	CTS1M	5	100	125	6
82	D	CTS1		CTS32	13,1	131	163	6					
100	D	CTS1		CTS32	16	160	200	6					
120	D	CTS1	CTS13	CTS32	19,2	192	240	8	CTS1M	9	180	226	8
150	D	CTS1	CTS13	CTS32	24	240	300	8	CTS1M	10	200	250	8
Rated voltage (+85°C) 20 V - Category voltage (+125°C) 13 V													
1,2	A								CTS1M	0,3	6	7,5	4
1,5	A								CTS1M	0,3	6	7,5	4
1,8	A		CTS13		1	3,6		6	CTS1M	0,3	6	7,5	4
2,2	A		CTS13		1	4,4		6	CTS1M	0,4	8	10	4
8,2	B								CTS1M	1	20	25	6
10	B								CTS1M	1,5	30	38	6
12	B		CTS13		2,4	24		6	CTS1M	1,8	35	44	6
15	B		CTS13		3	30		6	CTS1M	2	40	50	6
27	C								CTS1M	2,5	50	63	6
33	C								CTS1M	3,5	70	88	6
39	C		CTS13		7,8	78		6	CTS1M	4	80	100	6
47	C		CTS13		9,4	94		6	CTS1M	4,5	90	113	6
56	D								CTS1M	5,5	110	138	6
68	D								CTS1M	7	140	175	6
82	D		CTS13		16,4	164		6	CTS1M	8	160	200	6
100	D		CTS13		20	200		8	CTS1M	10	200	250	8
Rated voltage (+85°C) 25 V - Category voltage (+125°C) 16 V													
1,2	A			CTS32	1	3	3,7	6					
1,5	A	CTS1	CTS13	CTS32	1	3,7	4,6	6					
8,2	B	CTS1	CTS13	CTS32	2	20	25	6					
10	B	CTS1	CTS13	CTS32	2,5	25	31,2	6					

CTS1 - CTS13 CTS32 - CTS1M

STANDARD RATINGS - ELECTRICAL CHARACTERISTICS

Capacitance 100Hz +20°C (μF)	Case (code)	Type			Max. leakage current			Max. DF +20°C (%)	Type	Max. leakage current			Max. DF+25°C (%)
					+20°C (μA)	+85°C (μA)	+125°C (μA)			+25°C (μA)	+85°C (μA)	+125°C (μA)	
Rated voltage (+85°C) 25 V - Category voltage (+125°C) 16 V													
27	C	CTS1	CTS13	CTS32	6,7	67	84	6					
33	C	CTS1	CTS13	CTS32	8,2	82	102	6					
56	D	CTS1	CTS13	CTS32	14	140	175	6					
68	D	CTS1	CTS13	CTS32	17	170	212	6					
Rated voltage (+85°C) 40 V (35 V for CTS1M) - Category voltage (+125°C) 25 V (23 V for CTS1M)													
0,1	A	CTS1	CTS13		1	1	1	6					
0,12	A	CTS1	CTS13		1	1	1	6					
0,15	A	CTS1	CTS13		1	1	1	6					
0,18	A	CTS1	CTS13		1	1	1	6					
0,22	A	CTS1	CTS13		1	1	1,1	6					
0,27	A	CTS1	CTS13		1	1	1,3	6					
0,33	A	CTS1	CTS13		1	1,3	1,6	6					
0,39	A	CTS1	CTS13		1	1,5	1,9	6					
0,47	A	CTS1	CTS13		1	1,8	2,3	6					
0,56	A	CTS1	CTS13		1	2,2	2,8	6					
0,68	A	CTS1	CTS13		1	2,7	3,4	6					
0,82	A	CTS1	CTS13		1	3,2	4,1	6					
1	A	CTS1	CTS13	CTS32	1	4	5	6					
1,2	B	CTS1	CTS13	CTS32	1	4,8	6	6					
1,5	B	CTS1	CTS13	CTS32	1	6	7,5	6					
1,8	B	CTS1	CTS13	CTS32	1	7,2	9	6					
2,2	B	CTS1	CTS13	CTS32	1	8,8	11	6					
2,7	B	CTS1	CTS13	CTS32	1	10	13,5	6					
3,3	B	CTS1	CTS13	CTS32	1,3	13	16,2	6					
3,9	B	CTS1	CTS13	CTS32	1,5	15	18,7	6					
4,7	B	CTS1	CTS13	CTS32	1,8	18	22,5	6					
5,6	B	CTS1	CTS13	CTS32	2,2	22	27,5	6	CTS1M	1,3	25	32	4
6,8	B	CTS1	CTS13	CTS32	2,7	27	33,7	6	CTS1M	1,5	30	38	6
8,2	C	CTS1	CTS13	CTS32	3,2	32	40	6					
10	C	CTS1	CTS13	CTS32	4	40	50	6					
12	C	CTS1	CTS13	CTS32	4,8	48	60	6					
15	C	CTS1	CTS13	CTS32	6	60	75	6					
18	C	CTS1	CTS13	CTS32	7,2	72	90	6					
22	C	CTS1	CTS13	CTS32	8,8	88	110	6	CTS1M	4	80	100	6
27	D	CTS1	CTS13	CTS32	10,8	108	135	6	CTS1M	4,5	90	113	6
33	D	CTS1	CTS13	CTS32	13,2	132	165	6	CTS1M	5,5	110	138	6
39	D	CTS1	CTS13	CTS32	15,6	156	195	6	CTS1M	7	140	175	6
47	D	CTS1	CTS13	CTS32	18,8	188	235	6	CTS1M	8	160	200	6
Rated voltage (+85°C) 50 V - Category voltage (+125°C) 32 V													
0,1	A	CTS1	CTS13		1	1	1	6	CTS1M	0,3	5	6,3	2
0,12	A	CTS1	CTS13		1	1	1	6	CTS1M	0,3	5	6,3	2
0,15	A	CTS1	CTS13		1	1	1	6	CTS1M	0,3	5	6,3	2
0,18	A	CTS1	CTS13		1	1	1,1	6	CTS1M	0,3	5	6,3	2
0,22	A	CTS1	CTS13		1	1,1	1,3	6	CTS1M	0,3	5	6,3	2
0,27	A	CTS1	CTS13		1	1,3	1,6	6	CTS1M	0,3	5	6,3	2
0,33	A	CTS1	CTS13		1	1,6	2	6	CTS1M	0,3	5	6,3	2
0,39	A	CTS1	CTS13		1	1,9	2,4	6	CTS1M	0,3	5	6,3	2
0,47	A	CTS1	CTS13		1	2,3	2,9	6	CTS1M	0,3	5	6,3	2
0,56	A	CTS1	CTS13		1	2,8	3,5	6	CTS1M	0,3	5	6,3	2
0,68	A	CTS1	CTS13		1	3,4	4,2	6	CTS1M	0,3	5	6,3	2
0,82	A	CTS1	CTS13		1	4,1	5,1	6	CTS1M	0,3	5	6,3	2
1	A	CTS1	CTS13	CTS32	1	5	6,2	6	CTS1M	0,4	8	10	2
1,2	B	CTS1	CTS13	CTS32	1	6	7,5	6	CTS1M	0,4	9	11	4
1,5	B	CTS1	CTS13	CTS32	1	7,5	9,3	6	CTS1M	0,6	12	15	4
1,8	B	CTS1	CTS13	CTS32	1	9	11,2	6	CTS1M	0,7	14	18	4
2,2	B	CTS1	CTS13	CTS32	1,1	11	13,7	6	CTS1M	0,8	17	22	4
2,7	B	CTS1	CTS13	CTS32	1,3	13	16,2	6	CTS1M	1	20	25	4
3,3	B	CTS1	CTS13	CTS32	1,6	16	20	6	CTS1M	1,2	25	32	4
3,9	B	CTS1	CTS13	CTS32	1,9	19	24	6	CTS1M	1,5	30	38	4
4,7	B	CTS1	CTS13	CTS32	2,3	23	29	6	CTS1M	1,7	35	44	4
5,6	C	CTS1	CTS13	CTS32	2,8	28	35	6	CTS1M	2,2	45	56	4
6,8	C	CTS1	CTS13	CTS32	3,4	34	42	6	CTS1M	2,2	45	56	6
8,2	C	CTS1	CTS13	CTS32	4,1	41	51	6	CTS1M	2,5	50	63	6
10	C	CTS1	CTS13	CTS32	5	50	62	6	CTS1M	2,5	50	63	6

CTS1 - CTS13 CTS32 - CTS1M

STANDARD RATINGS - ELECTRICAL CHARACTERISTICS

Capacitance 100Hz +20°C (μF)	Case (code)	Type			Max. leakage current			Max. DF +20°C (%)	Type	Max. leakage current			Max. DF +25°C (%)
					+20°C (μA)	+85°C (μA)	+125°C (μA)			+25°C (μA)	+85°C (μA)	+125°C (μA)	
Rated voltage (+85°C) 50 V - Category voltage (+125°C) 32 V													
12	C	CTS1	CTS13	CTS32	6	60	75	6	CTS1M	3	60	75	6
15	C	CTS1	CTS13	CTS32	7,5	75	93	6	CTS1M	4	80	100	6
18	C	CTS1	CTS13	CTS32	9	90	112	6	CTS1M	4,5	90	113	6
22	D	CTS1	CTS13	CTS32	11	110	137	6	CTS1M	5,5	110	138	6
Rated voltage (+85°C) 63 V - Category voltage (+125°C) 40 V													
0,1	A	CTS1	CTS13		1	1	1	6					
0,12	A	CTS1	CTS13		1	1	1	6					
0,15	A	CTS1	CTS13		1	1	1,1	6					
0,18	A	CTS1	CTS13		1	1,1	1,4	6					
0,22	A	CTS1	CTS13		1	1,3	1,7	6					
0,27	A	CTS1	CTS13		1	1,7	2,1	6					
0,33	A	CTS1	CTS13		1	2	2,5	6					
0,39	A	CTS1	CTS13		1	2,4	3	6					
0,47	A	CTS1	CTS13		1	2,9	3,7	6					
0,56	A	CTS1	CTS13		1	3,5	4,4	6					
0,68	A	CTS1	CTS13		1	4,2	5,3	6					
0,82	B	CTS1	CTS13		1	5,1	6,4	6					
1	B	CTS1	CTS13	CTS32	1	6,3	7,8	6					
1,2	B	CTS1	CTS13	CTS32	1	7,5	9,4	6					
1,5	B	CTS1	CTS13	CTS32	1	9,4	11,8	6					
1,8	B	CTS1	CTS13	CTS32	1,1	11	13,7	6					
2,2	B	CTS1	CTS13	CTS32	1,3	13	16,2	6					
2,7	B	CTS1	CTS13	CTS32	1,7	17	21,2	6					
3,3	B	CTS1	CTS13	CTS32	2	20	25	6					
3,9	B	CTS1	CTS13	CTS32	2,4	24	30	6					
4,7	C	CTS1	CTS13	CTS32	2,9	29	37	6					
5,6	C	CTS1	CTS13	CTS32	3,5	35	44	6					
6,8	C	CTS1	CTS13	CTS32	4,2	42	53	6					
8,2	C	CTS1	CTS13	CTS32	5,1	51	64	6					
10	C	CTS1	CTS13	CTS32	6,3	63	78	6					
12	D	CTS1	CTS13	CTS32	7,5	75	94	6					
15	D	CTS1	CTS13	CTS32	9,4	94	118	6					
18	D	CTS1	CTS13	CTS32	11,3	113	141	6					
22	D	CTS1	CTS13	CTS32	13,8	138	173	6					
Rated voltage (+85°C) 80 V (75 V for CTS1M) - Category voltage (+125°C) 50 V													
0,1	A	CTS1			1	1	1	6	CTS1M	0,3	5	6,3	2
0,12	A	CTS1			1	1	1,2	6	CTS1M	0,3	5	6,3	2
0,15	A	CTS1			1	1,2	1,5	6	CTS1M	0,3	5	6,3	2
0,18	A	CTS1			1	1,4	1,8	6	CTS1M	0,3	5	6,3	2
0,22	A	CTS1			1	1,7	2,2	6	CTS1M	0,3	5	6,3	2
0,27	A	CTS1			1	2,1	2,7	6	CTS1M	0,3	5	6,3	2
0,33	A	CTS1			1	2,6	3,3	6	CTS1M	0,3	5	6,3	2
0,39	A	CTS1			1	3,1	3,9	6	CTS1M	0,3	5	6,3	2
0,47	A	CTS1			1	3,7	4,7	6	CTS1M	0,3	5	6,3	2
0,56	A	CTS1			1	4,4	5,6	6	CTS1M	0,3	5	6,3	2
0,68	A	CTS1			1	5,4	6,8	6	CTS1M	0,3	5	6,3	2
0,82	B	CTS1			1	6,5	8,2	6	CTS1M	0,3	5	6,3	2
1	B	CTS1			1	8	10	6	CTS1M	0,3	5	6,3	2
1,2	B	CTS1			1	9,6	12	6	CTS1M	0,3	5	6,3	4
1,5	B	CTS1			1,2	12	15	6	CTS1M	0,6	10	13	4
1,8	B	CTS1			1,4	14	18	6	CTS1M	0,7	10	13	4
2,2	B	CTS1			1,7	17	22	6	CTS1M	0,8	15	19	4
2,7	B	CTS1			2,1	21	27	6	CTS1M	1	15	19	4
3,3	B	CTS1			2,6	26	33	6	CTS1M	1,2	20	25	4
3,9	B	CTS1			3,1	31	39	6	CTS1M	1,5	20	25	4
4,7	C	CTS1			3,7	37	47	6	CTS1M	3	60	75	4
5,6	C	CTS1			4,4	44	56	6	CTS1M	3	60	75	4
6,8	C	CTS1			5,4	54	68	6	CTS1M	5	100	125	6
8,2	C	CTS1			6,5	65	82	6	CTS1M	5	100	125	6
10	C	CTS1			8	80	100	6	CTS1M	5	100	125	6
12	D	CTS1			9,6	96	120	6	CTS1M	5	100	125	6
15	D	CTS1			12	120	150	6	CTS1M	7	140	175	6

CTS1 - CTS13

CTS32 - CTS1M

STANDARD RATINGS - ELECTRICAL CHARACTERISTICS

Capacitance 100Hz +20°C (μF)	Case (code)	Type	Max. leakage current			Max. DF +20°C (%)	Type	Max. leakage current			Max. DF +25°C (%)
			+20°C (μA)	+85°C (μA)	+125°C (μA)			+25°C (μA)	+85°C (μA)	+125°C (μA)	
Rated voltage (+85°C) 100 V - Category voltage (+125°C) 63 V											
0,1	A	CTS1	1	1	1,2	6	CTS1M	0,3	5	6,3	2
0,12	A	CTS1	1	1,2	1,5	6	CTS1M	0,3	5	6,3	2
0,15	A	CTS1	1	1,5	1,8	6	CTS1M	0,3	5	6,3	2
0,18	A	CTS1	1	1,8	2,2	6	CTS1M	0,3	5	6,3	2
0,22	A	CTS1	1	2,2	2,7	6	CTS1M	0,3	5	6,3	2
0,27	A	CTS1	1	2,7	3,3	6	CTS1M	0,3	5	6,3	2
0,33	A	CTS1	1	3,3	4,1	6	CTS1M	0,3	5	6,3	2
0,39	A	CTS1	1	3,9	4,8	6	CTS1M	0,3	5	6,3	2
0,47	A	CTS1	1	4,7	5,8	6	CTS1M	0,3	5	6,3	2
0,56	A	CTS1	1	5,6	7	6	CTS1M	0,3	5	6,3	2
0,68	B	CTS1	1	6,8	8,5	6	CTS1M	0,3	5	6,3	2
0,82	B	CTS1	1	8,2	10	6	CTS1M	0,4	5	6,3	2
1	B	CTS1	1	10	12	6	CTS1M	0,5	5	6,3	2
1,2	B	CTS1	1,2	12	15	6	CTS1M	0,5	5	6,3	4
1,5	B	CTS1	1,5	15	18	6	CTS1M	0,7	10	13	4
1,8	B	CTS1	1,8	18	22	6	CTS1M	0,7	10	13	4
2,2	B	CTS1	2,2	22	27	6	CTS1M	0,9	15	19	4
2,7	B	CTS1	2,7	27	33	6	CTS1M	1,1	15	19	4
3,3	C	CTS1	3,3	33	41	6	CTS1M	1,5	30	38	6
3,9	C	CTS1	3,9	39	48	6	CTS1M	1,5	30	38	6
4,7	C	CTS1	4,7	47	58	6	CTS1M	2,5	50	63	6
5,6	C	CTS1	5,6	56	70	6	CTS1M	2,5	50	63	6
6,8	C	CTS1	6,8	68	85	6	CTS1M	2,5	50	63	6
8,2	D	CTS1	8,2	82	102	6					
10	D	CTS1	10	100	125	6					
Rated voltage (+85°C) 125 V - Category voltage (+125°C) 80 V											
0,1	A	CTS1	1	1,2	1,5	6					
0,12	A	CTS1	1	1,5	1,8	6					
0,15	A	CTS1	1	1,8	2,3	6					
0,18	A	CTS1	1	2,2	2,8	6					
0,22	A	CTS1	1	2,7	3,4	6					
0,27	A	CTS1	1	3,3	4,2	6					
0,33	A	CTS1	1	4,1	5,1	6					
0,39	B	CTS1	1	4,8	6	6					
0,47	B	CTS1	1	5,8	7,3	6					
0,56	B	CTS1	1	7	8,7	6					
0,68	B	CTS1	1	8,5	10	6					
0,82	B	CTS1	1	10	12	6					
1	B	CTS1	1,2	12	15	6					
1,2	B	CTS1	1,5	15	18	6					
1,5	B	CTS1	1,8	18	23	6					
1,8	B	CTS1	2,2	22	28	6					
2,2	B	CTS1	2,7	27	34	6					
2,7	C	CTS1	3,3	33	42	6					
3,3	C	CTS1	4,1	41	51	6					
3,9	C	CTS1	4,8	48	60	6					
4,7	C	CTS1	5,8	58	73	6					
5,6	C	CTS1	7	70	87	6					
6,8	C	CTS1	8,5	85	106	6					
8,2	D	CTS1	10,2	102	128	6					
10	D	CTS1	12,5	125	156	6					

CTS23

CTS33

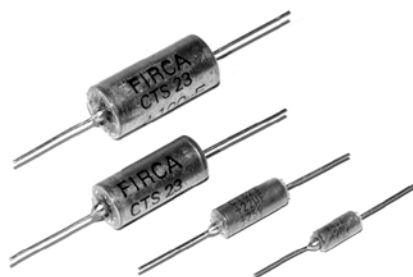

Solid tantalum MnO₂ capacitors
Hermetically sealed metal cases
 Axial leads
General purpose - Extended range
 Polarized

ELECTRICAL AND CLIMATIC CHARACTERISTICS

	CTS23	CTS33
Detail specification	According to CECC 30201-025	According to CECC 30201-026
Operating temperature	-55°C +125°C	-55°C +125°C
Damp heat	56 days	56 days
Capacitance range	1μF ⇒ 1200μF	1,2μF ⇒ 1000μF
Tolerance	±10% - ±20%	±10% - ±20%
Voltage range	6,3V ⇒ 63V	6,3V ⇒ 50V
Max. capacitance change -55°C	-10%	-10%
Max. capacitance change +85°C	+12%	+8%
Max. capacitance change +125°C	+15%	+12%
Maximum DF at +20°C	see table	see table
Maximum DF at -55°C	= lim20°C	= lim20°C
Maximum DF at +85°C	= lim20°C	= lim20°C
Maximum DF at +125°C	= lim20°C	= lim20°C
Max. leakage current at +20°C	see table	see table
Max. leakage current at +85°C	0,1 x C _R U _R	0,1 x C _R U _R
Max. leakage current at +125°C	0,125 x C _R U _R	0,125 x C _R U _R
Max. impedance (20°C): case A	10 Ω	10 Ω
Max. impedance (20°C): case B	5 Ω	5 Ω
Max. impedance (20°C): case C	2 Ω	2 Ω
Max. impedance (20°C): case D	1 Ω	1 Ω
High surge current	1 million cycles	1 million cycles
Max. Reverse voltage at +20°C	15 % U _R	15 % U _R
Max. Reverse voltage at +85°C	5 % U _R	5 % U _R
Max. Reverse voltage at +125°C	1 % U _R	1 % U _R
Max. surge voltage at +85°C	1,3 x U _R	1,3 x U _R
Max. surge voltage at +125°C	1,3 x U _C	1,3 x U _C

DIMENSIONS (mm)

Case code	Dimensions with insulating sleeve			
	Lt max	L max	D max	d +10%/-0,05
A	10,2	8,1	3,6	0,5
B	15,0	12,8	4,9	0,5
C	20,5	18,2	7,5	0,6
D	24,0	20,8	9,1	0,6

MARKING, PACKAGING, CONSTRUCTION:
 see general characteristics

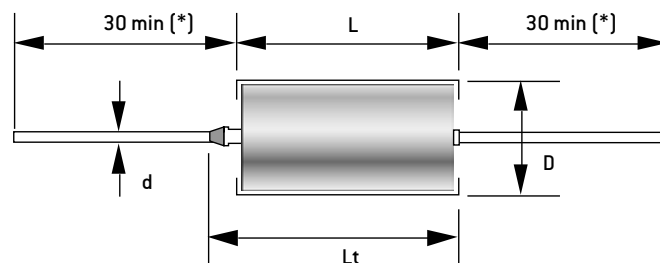

[*] 23mm for capacitors delivered on tape

HOW TO ORDER

Commercial description	Model		Case	Capacitance in μF	Tolerance in %	DC Voltage	Termination
		CTS23	CTS33	D	560μF	20%	10V
EXXELIA PN	Model code		Case	Capacitance code	Tolerance code	DC Voltage code	Termination
	TS23	TS33	D	567	M	010	A
	Expressed in pF with 3 digits: 2 digits for the value and the third for the multiplier			K = 10% M = 20%	Expressed in volt with 3 digits	Commercial description H = SnPb (non RoHS) - = Sn100% (RoHS)	EXXELIA PN A = SnPb (non RoHS) F = Sn100% (RoHS)

CTS23

CTS33

STANDARD RATINGS - ELECTRICAL CHARACTERISTICS

Capacitance 100Hz +20°C (μF)	Case (code)	Type	Max. I leak +20°C (μA)	Max. DF +20°C (%)	Type	Max. I leak +20°C (μA)	Max. DF +20°C (%)
Rated voltage (+85°C) 6,3 V - Category voltage (+125°C) 4 V							
12	A	CTS23	1	6	CTS33	1	6
15	A	CTS23	1	6	CTS33	1	6
100	B	CTS23	6,3	8	CTS33	1	8
120	B	CTS23	7,5	8	CTS33	1	8
330	C	CTS23	20,8	10	CTS33	2	10
390	C	CTS23	24,5	10	CTS33	2,4	10
470	C	CTS23	29,6	10	CTS33	2,9	10
680	D	CTS23	42,8	10	CTS33	4,2	10
820	D	CTS23	51,6	10	CTS33	5,1	10
1000	D	CTS23	63,0	10	CTS33	6,3	10
1200*	D	CTS23	75,6	10			
Rated voltage (+85°C) 10 V - Category voltage (+125°C) 6,3 V							
8,2	A	CTS23	1	6	CTS33	1	6
10	A	CTS23	1	6	CTS33	1	6
47	B	CTS23	4,7	6	CTS33	1	6
56	B	CTS23	5,6	6	CTS33	1	6
68	B	CTS23	6,8	8	CTS33	1	8
82	B	CTS23	8,2	8	CTS33	1	8
220	C	CTS23	22	10	CTS33	2,2	10
270	C	CTS23	27	10	CTS33	2,7	10
390	D	CTS23	39	10	CTS33	3,9	10
470	D	CTS23	47	10	CTS33	4,7	10
560	D	CTS23	56	10	CTS33	5,6	10
Rated voltage (+85°C) 16 V - Category voltage (+125°C) 10 V							
5,6	A	CTS23	1	6	CTS33	1	6
6,8	A	CTS23	1	6	CTS33	1	6
33	B	CTS23	5,2	6	CTS33	1	6
39	B	CTS23	6,2	8	CTS33	1	8
150	C	CTS23	24	10	CTS33	2,4	10
180	C	CTS23	28,8	10	CTS33	2,8	10
270	D	CTS23	43,2	10	CTS33	4,3	10
330	D	CTS23	52,8	10	CTS33	5,2	10
Rated voltage (+85°C) 20 V - Category voltage (+125°C) 13 V							
3,9	A	CTS23	1	6	CTS33	1	6
4,7	A	CTS23	1	6	CTS33	1	6
27	B	CTS23	5,4	6	CTS33	1	6
100	C	CTS23	20	10	CTS33	2	10
120	C	CTS23	24	10	CTS33	2,4	10
180	D	CTS23	36	10	CTS33	3,6	10
220	D	CTS23	44	10	CTS33	4,4	10
Rated voltage (+85°C) 25 V - Category voltage (+125°C) 16 V							
2,2	A	CTS23	1	6	CTS33	1	6
2,7	A	CTS23	1	6	CTS33	1	6
3,3	A	CTS23	1	6	CTS33	1	6
12	B	CTS23	3	6	CTS33	1	6
15	B	CTS23	3,7	6	CTS33	1	6
18	B	CTS23	4,5	6	CTS33	1	6
22	B	CTS23	5,5	6	CTS33	1	6
Rated voltage (+85°C) 25 V - Category voltage (+125°C) 16 V							
56	C	CTS23	14	8	CTS33	1,4	8
68	C	CTS23	17	8	CTS33	1,7	8
82	C	CTS23	20,5	10	CTS33	2	10
100*	D	CTS23	25	10	CTS33	2,5	10
120	D	CTS23	30	10	CTS33	3	10
150	D	CTS23	37,5	10	CTS33	3,7	10

* out of CECC range

CTS23

CTS33

STANDARD RATINGS - ELECTRICAL CHARACTERISTICS

Capacitance 100Hz +20°C (μF)	Case (code)	Type	Max. I leak +20°C (μA)	Max. DF +20°C (%)	Type	Max. I leak +20°C (μA)	Max. DF +20°C (%)
Rated voltage (+85°C) 40 V - Category voltage (+125°C) 16 V							
1,2	A				CTS33	1	6
1,5	A	CTS23	1	6	CTS33	1	6
1,8	A	CTS23	1	6	CTS33	1	6
8,2	B	CTS23	3,2	6	CTS33	1	6
10	B	CTS23	4	6	CTS33	1	6
27	C	CTS23	10,8	8	CTS33	1	8
33	C	CTS23	13,2	8	CTS33	1,3	8
39	C	CTS23	15,6	8	CTS33	1,5	8
47	C	CTS23	18,8	8	CTS33	1,8	8
56	D	CTS23	22,4	10	CTS33	2,2	10
68	D	CTS23	27,2	10	CTS33	2,7	10
82	D	CTS23	32,8	10	CTS33	3,2	10
100	D	CTS23	40	10	CTS33	4	10
120*	D	CTS23	48	10			
Rated voltage (+85°C) 50 V - Category voltage (+125°C) 32 V							
1,2	A	CTS23	1	6	CTS33	1	6
1,5	A	CTS23	1	6	CTS33	1	6
5,6	B	CTS23	2,8	6	CTS33	1	6
6,8	B	CTS23	3,4	6	CTS33	1	6
22	C	CTS23	11	8	CTS33	1,1	8
27	C	CTS23	13,5	8	CTS33	1,3	8
33	D	CTS23	16,5	8	CTS33	1,6	8
39	D	CTS23	19,5	8	CTS33	1,9	8
47*	D	CTS23	23,5	10			
56*	D	CTS23	28	10			
68*	D	CTS23	34	10			
Rated voltage (+85°C) 63 V - Category voltage (+125°C) 40 V							
1*	A	CTS23	1	6			
4,7*	B	CTS23	2,9	6			
5,6*	B	CTS23	3,5	6			
15*	C	CTS23	9,4	8			
18*	C	CTS23	11,3	8			
22*	C	CTS23	13,8	8			
27*	D	CTS23	17	8			
33*	D	CTS23	20,8	10			
39*	D	CTS23	24,5	10			
47*	D	CTS23	29,6	10			

* out of CECC range

CTS21 CTS21E

Solid tantalum MnO₂ capacitors
Hermetically sealed metal cases
 Axial leads
For power supplies and converters
 Polarized



ELECTRICAL AND CLIMATIC CHARACTERISTICS

	CTS21	CTS21E
Detail specification	CECC 30201-040	CECC 30201-040
Operating temperature	-55°C +125°C	-55°C +125°C
Damp heat	56 days	56 days
Capacitance range	5,6µF ⇒ 330µF	22µF ⇒ 1000µF
Tolerance	± 10% - ± 20%	± 10% - ± 20%
Voltage range	6,3V ⇒ 50V	6,3V ⇒ 50V
Max. capacitance change -55°C	-10%	-10%
Max. capacitance change +85°C	+8%	+8%
Max. capacitance change +125°C	+12%	+12%
Maximum DF at +20°C	see table	see table
Maximum DF at -55°C	= 2 x lim20°C	= 2 x lim20°C
Maximum DF at +85°C	= 1,5 x lim20°C	= 1,5 x lim20°C
Maximum DF at +125°C	= 1,5 x lim20°C	= 1,5 x lim20°C
Max. leakage current at +20°C	see table	see table
Max. leakage current at +85°C	0,1 x C _R U _R	0,1 x C _R U _R
Max. leakage current at +125°C	0,125 x C _R U _R	0,125 x C _R U _R
Max. ESR at 100kHz +20°C	see table	see table
Max. ripple current 1kHz +20°C	see table	see table
Max. ripple current 100kHz +20°C	see table	see table
High surge current	1 million cycles	1 million cycles
Max. Reverse voltage at +20°C	15 % U _R	15 % U _R
Max. Reverse voltage at +85°C	5 % U _R	5 % U _R
Max. Reverse voltage at +125°C	1 % U _R	1 % U _R
Max. surge voltage at +85°C	1,3 x U _R	1,3 x U _R
Max. surge voltage at +125°C	1,3 x U _C	1,3 x U _C

DIMENSIONS (mm)

Case code	Dimensions with insulating sleeve			
	Lt max	L max	D max	d +10%/-0,05
C	20,5	18,2	7,5	0,6
D	24,0	20,8	9,1	0,6

MARKING, PACKAGING, CONSTRUCTION:
 see general characteristics

HOW TO ORDER

Commercial description	Model		Case	Capacitance in µF	Tolerance in %	DC Voltage	Termination	
	CTS21	CTS21E						D
EXXELIA PN	Model code		Case	Capacitance code	Tolerance code	DC Voltage code	Termination	
	TS21	TS21E						D
				Expressed in pF with 3 digits: 2 digits for the value and the third for the multiplier	K = 10% M = 20%	Expressed in volt with 3 digits	Commercial description H = SnPb (No RoHS) - = Sn100% (RoHS)	EXXELIA PN A = SnPb (No RoHS) F = Sn100% (RoHS)

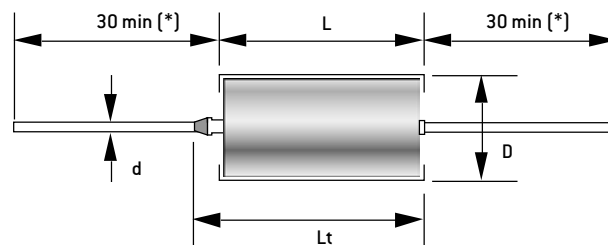

CTS21**[Standard range]****STANDARD RATINGS - ELECTRICAL CHARACTERISTICS**

Capacitance 1kHz +20°C (μ F)	Case (code)	Type	Max. I leak +20°C (μ A)	Max. DF 1kHz +20°C (%)	Max. ESR 100kHz +20°C (m Ω)	I _{rms} Max. 1kHz +20°C (A)	I _{rms} Max. 100kHz +20°C (A)
Rated voltage (+85°C) 6,3 V (6 V for CTS21M) - Category voltage (+125°C) 4 V							
120	C	CTS21	7,6	8	70	2,5	3,2
150	C	CTS21	9,4	10	65	2	3,3
270	D	CTS21	17	10	50	3,4	4,1
330	D	CTS21	20,8	12	45	3,8	4,3
Rated voltage (+85°C) 10 V - Category voltage (+125°C) 6,3 V							
82	C	CTS21	8,2	8	85	1,8	2,9
100	C	CTS21	10	8	75	2,2	3
180	D	CTS21	18	8	60	3,4	3,7
220	D	CTS21	22	10	55	3,4	3,9
Rated voltage (+85°C) 16 V (15 V for CTS21M) - Category voltage (+125°C) 10 V							
56	C	CTS21	8,9	6	100	1,8	2,6
68	C	CTS21	10,8	6	95	2,2	2,7
120	D	CTS21	19,2	8	70	2,8	3,5
150	D	CTS21	24	8	65	3,1	3,6
Rated voltage (+85°C) 20 V - Category voltage (+125°C) 13 V							
39	C	CTS21	7,8	5	120	1,7	2,4
47	C	CTS21	9,4	6	110	1,8	2,5
82	D	CTS21	16,4	6	85	2,5	3,1
100	D	CTS21	20	8	75	2,5	3,3
Rated voltage (+85°C) 25 V - Category voltage (+125°C) 16 V							
27	C	CTS21	6,7	5	145	1,2	2,2
33	C	CTS21	8,2	5	130	1,4	2,3
56	D	CTS21	14	6	100	2,2	2,9
68	D	CTS21	17	6	95	2,4	3
Rated voltage (+85°C) 35 or 40 V (35 V for CTS21M) - Category voltage (+125°C) 23 or 25 V							
22	C	CTS21	7,7	4	160	1,5	2,1
27	D	CTS21	9,5	4	145	1,9	2,4
33	D	CTS21	11,6	5	130	1,9	2,5
39	D	CTS21	13,7	5	120	2	2,6
47	D	CTS21	16,5	5	110	2,2	2,7
Rated voltage (+85°C) 50 V - Category voltage (+125°C) 32 V							
5,6	C	CTS21	2,8	3	300	0,6	1,5
6,8	C	CTS21	3,4	3	275	0,7	1,6
8,2	C	CTS21	4,1	3	250	0,9	1,6
10	C	CTS21	5	3	230	1,1	1,7
12	C	CTS21	6	3	210	1,3	1,8
15	C	CTS21	7,5	3	190	1,4	1,9
18	C	CTS21	9	4	175	1,4	2,0
22	D	CTS21	11	4	160	1,7	2,3

[Extended range]

CTS21E

STANDARD RATINGS - ELECTRICAL CHARACTERISTICS

Capacitance 1kHz +20°C (μF)	Case (code)	Type	Max. I leak +20°C (μA)	Max. DF 1kHz +20°C (%)	Max. ESR 100kHz +20°C (mΩ)	Irms Max. 1kHz +20°C (A)	Irms Max. 100kHz +20°C (A)
Rated voltage (+85°C) 6,3 V - Category voltage (+125°C) 4 V							
330	C	CTS21E	20,8	12	45	2,4	3,9
390	C	CTS21E	24,6	12	40	2,6	4,1
470	C	CTS21E	29,6	14	40	2,6	4,2
680	D	CTS21E	42,8	18	35	4,0	5,2
820	D	CTS21E	51,7	18	30	4,0	5,2
1000	D	CTS21E	63	22	30	4,1	5,7
Rated voltage (+85°C) 10 V - Category voltage (+125°C) 6,3 V							
220	C	CTS21E	22	10	55	2,2	3,6
270	C	CTS21E	27	10	50	2,4	3,7
390	D	CTS21E	39	12	40	3,8	4,5
470	D	CTS21E	47	14	40	3,8	4,5
560	D	CTS21E	56	14	35	3,9	4,8
Rated voltage (+85°C) 16 V - Category voltage (+125°C) 10 V							
150	C	CTS21E	24	10	65	2,0	3,3
180	C	CTS21E	28,8	10	60	2,4	3,4
270	D	CTS21E	43,2	10	50	3,4	4,1
330	D	CTS21E	52,8	12	45	3,8	4,3
Rated voltage (+85°C) 20 V - Category voltage (+125°C) 13 V							
100	C	CTS21E	20	8	75	2,2	3,0
120	C	CTS21E	24	8	70	2,5	3,2
180	D	CTS21E	36	10	60	3,4	3,7
220	D	CTS21E	44	10	55	3,4	3,9
Rated voltage (+85°C) 25 V - Category voltage (+125°C) 16 V							
56	C	CTS21E	14	6	100	1,8	2,6
68	C	CTS21E	17	6	95	2,2	2,7
82	C	CTS21E	20,5	6	85	2,2	2,9
150	D	CTS21E	37,5	10	65	2,8	3,6
Rated voltage (+85°C) 35 or 40 V - Category voltage (+125°C) 23 or 25 V							
33	C	CTS21E	11,5	5	130	1,4	2,3
39	C	CTS21E	13,6	5	120	1,7	2,4
47	C	CTS21E	16,4	6	110	1,8	2,5
56	D	CTS21E	19,6	6	100	2,2	2,9
68	D	CTS21E	23,8	6	95	2,4	3,0
82	D	CTS21E	28,7	6	85	2,5	3,1
100	D	CTS21E	35	8	75	2,5	3,3
120	D	CTS21E	42	8	70	2,8	3,5
Rated voltage (+85°C) 50 V - Category voltage (+125°C) 32 V							
22	C	CTS21E	11	4	160	1,5	2,1
27	C	CTS21E	13,5	5	145	1,5	2,2
33	D	CTS21E	16,5	5	130	1,9	2,5
39	D	CTS21E	19,5	5	120	2,0	2,6
47	D	CTS21E	23,5	6	110	2,2	2,7
56	D	CTS21E	28	6	100	2,2	2,9
68	D	CTS21E	34	6	95	2,4	3,0
Rated voltage (+85°C) 63 V - Category voltage (+125°C) 40 V							
47*	D	CTS21E	29,6	10	110	2,2	2,7

* out of CECC range

Radial leads - General characteristics

Applicable for types see below:

General purpose: CTS4, CTS41, CTS27

Special for power supplies and converters: CTS41ESR

CONSTRUCTION

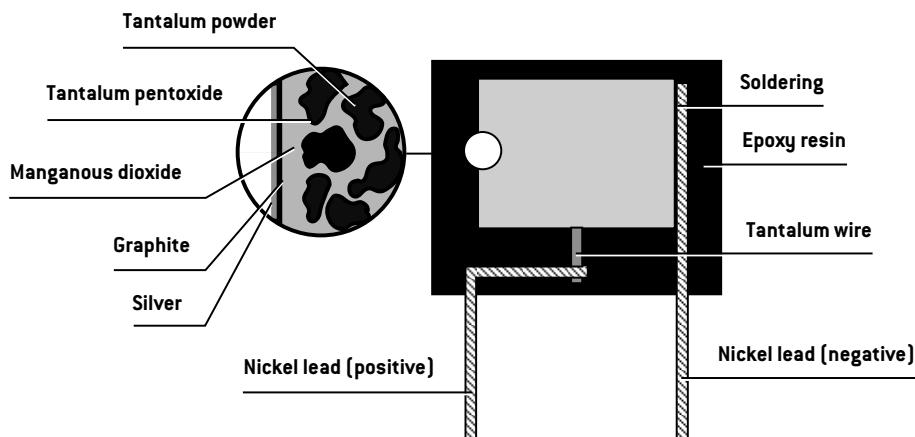

MARKING

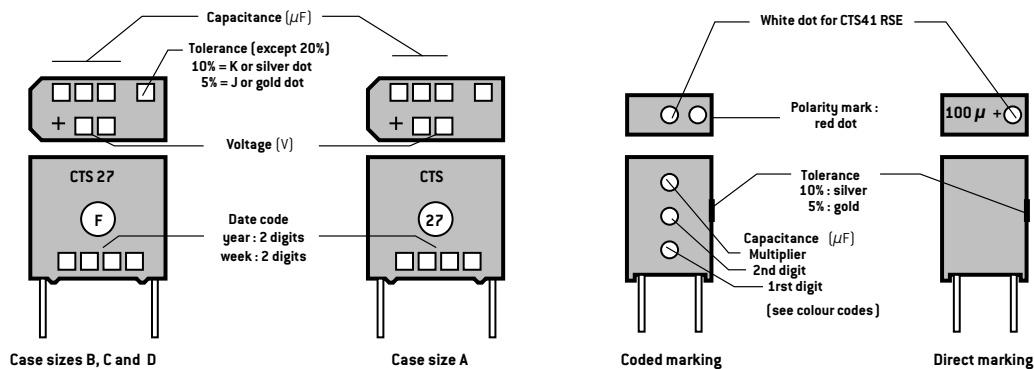

COLOR CODE

Color	Digit	Multiplier	Color	Digit	Multiplier
Black	0		Green	5	÷ 10
Brown	1		Blue	6	x 1
Red	2		Purple	7	x 10
Orange	3		Grey	8	
Yellow	4	÷ 100	White	9	

PACKAGING

CTS27: case sizes A and B: on tape (see next page)
case sizes C and D: boxes or plastic bags

CTS41 - CTS4 - CTS41 RSE:
boxes or plastic bags

Radial leads - Tape & Reel packaging

TAPING FOR CTS27 TYPE (mm)

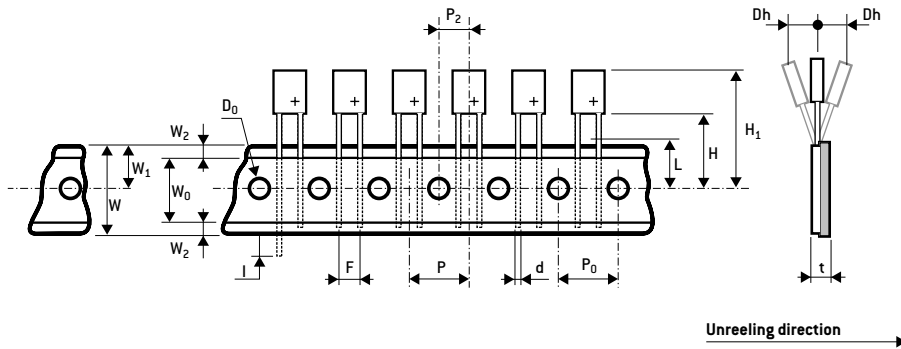

Note:
For cases A and B only

REEL SIZE (mm)

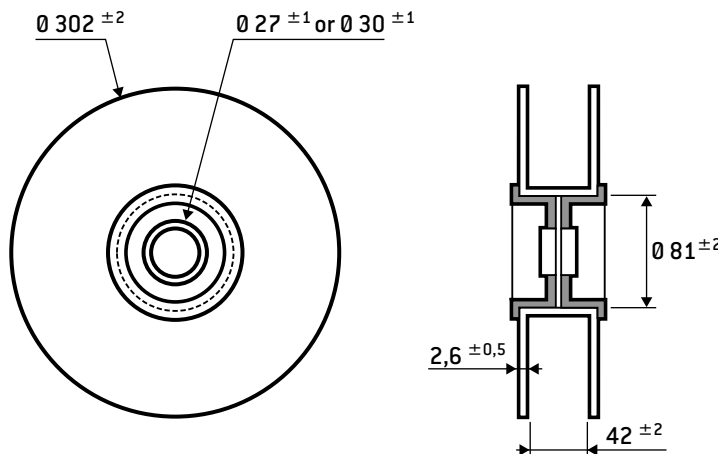

Symbol	Designation	Dimensions	Symbol	Designation	Dimensions
W	Tape width	18 ⁺¹ _{-0,5}	L	Length of residual snapped leads	11 max.
W	Hold-down tape width	12,5 min.	P ₀	Sprocket hole pitch *	12,7 ± 0,3
W ₂	Hold-down tape position	3 max.	Δh	Lateral deviation of component	± 2 max.
W ₁	Sprocket hole position	3 ^{+0,75} _{-0,5}	P	Component pitch	12,7 ± 1
D ₀	Sprocket hole diameter	4 ± 0,3	t	Total tape thickness	0,7 ± 2
H	Component base to tape center	18 ⁺² ₋₀	Case code		A B
H ₁	Component top to tape center	32,2 max.	F	Lead wire spacing **	2,54 ^{+0,6} _{-0,2} 5,08 ^{+0,6} _{-0,2}
d	Lead wire diameter	0,5 ± 0,05	P ₁	Hole center to component center	5,08 ± 0,7 3,85 ± 0,7
I	Lead protrusion	2 max.	P ₂	Hole center to lead center	6,35 ± 1,3 6,35 ± 1,3

* Pitch tolerance over any 20 pitch = ± 1 mm

** F. measured at the upper edge of the tape
Quantity of unit per reel = 1000

CTS41 - CTS4

CTS41 RSE

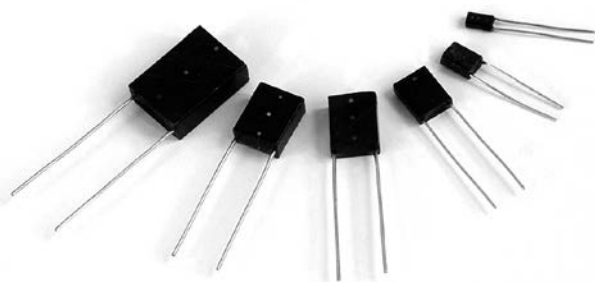

Solid tantalum MnO₂ capacitors
Molded cases
Radial leads
 Polarized

ELECTRICAL AND CLIMATIC CHARACTERISTICS

	CTS41	CTS4	CTS41 RSE
Detail specification	CECC 30201-037	CECC 30201-003	
Operating temperature	-55°C +125°C	-55°C +85°C	-55°C +125°C
Damp heat	56 days	21 days	56 days
Capacitance range	0,1μF ⇒ 150μF	0,1μF ⇒ 150μF	4,7μF ⇒ 150μF
Tolerance	±10% - ±20%	±10% - ±20%	±10% - ±20%
Voltage range	6,3V ⇒ 50V	6,3V ⇒ 50V	6,3V ⇒ 50V
Max. capacitance change -55°C	-10%	-10%	-10%
Max. capacitance change +85°C	+12%	+12%	+12%
Max. capacitance change +125°C	+15%	---	+15%
Maximum DF at +20°C	see table	see table	see table
Maximum DF at -55°C	= 1,5 x lim20°C	= 1,5 x lim20°C	= 1,5 x lim20°C
Maximum DF at +85°C	= 1,5 x lim20°C	= 1,5 x lim20°C	= 1,5 x lim20°C
Maximum DF at +125°C	= 2,0 x lim20°C	---	= 2,0 x lim20°C
Max. leakage current at +20°C	see table	see table	see table
Max. leakage current at +85°C	see table	see table	see table
Max. leakage current at +125°C	see table	---	see table
Max. ESR at 100kHz +20°C	---	---	see table
Max. impedance (100kHz) +20°C	see table	see table	---
Max. ripple current 100kHz +20°C	---	---	see table
High surge current	1 million cycles	no	1 million cycles
Max. Reverse voltage at +20°C	10 % U _R	---	10 % U _R
Max. Reverse voltage at +85°C	5 % U _R	---	5 % U _R
Max. Reverse voltage at +125°C	1 % U _R	---	1 % U _R
Max. surge voltage at +85°C	1,3 x U _R	1,3 x U _R	1,3 x U _R
Max. surge voltage at +125°C	1,3 x U _C	---	1,3 x U _C

DIMENSIONS (mm)

Case code	Dimensions				
	L max	H max	E max	e ± 0,3	d +10%/-0,05
A	2,1	3,4	1,8	1,27	0,3
B	3,3	4,4	2,1	2,54	0,3
C	4,9	5,9	2,1	3,81	0,3
D	6,0	7,6	3,0	5,08	0,4
E	6,1	8,1	3,5	5,08	0,4
F	9,8	12,3	4,1	7,62	0,4

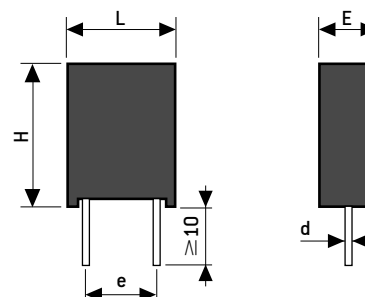

MARKING, PACKAGING, CONSTRUCTION:
 see general characteristics

HOW TO ORDER

Commercial description	Model			Case	Capacitance in μF	Tolerance in %	DC Voltage	Termination
	CTS41	CTS4	CTS41 RSE					
EXXELIA PN	Model code			Case	Capacitance code	Tolerance code	DC Voltage code	Termination
	TS41	TS04	TS12	F	476	M	020	A

Expressed in pF with 3 digits:
 2 digits for the value
 and the third for the multiplier

K = 10%
 M = 20%

Expressed in volt
 with 3 digits

Commercial description
 H = SnPb (No RoHS)
 - = Sn100% (RoHS)

EXXELIA PN
 A = SnPb (No RoHS)
 F = Sn100% (RoHS)

CTS41 - CTS4 CTS41 RSE

STANDARD RATINGS - ELECTRICAL CHARACTERISTICS

Capacitance 100Hz +20°C (μF)	Case (code)	Type	Max. I leak			Max. DF +20°C (%)	Max. Impedance +20°C (Ω)	Type	Max. I leak +20°C (μA)	Max. DF +20°C (%)	Max. ESR 100kHz +20°C (mΩ)	Irms Max. +20°C (A)	
			+20°C (μA)	+85°C (μA)	+125°C (μA)								
Rated voltage (+85°C) 6,3 V - Category voltage (+125°C) 4 V													
0,47	A		CTS4	1	1	-	6	10					
0,68*	A		CTS4	1	1	-	6	10					
3,3	B	CTS41	CTS4	1	2,1	2,1	6	10					
10	C	CTS41	CTS4	1	6,3	6,3	6	5	CTS41 RSE	1	6	400	0,40
33	D	CTS41	CTS4	2,1	21	21	6	5	CTS41 RSE	2,1	6	220	0,65
47	E	CTS41	CTS4	3	30	30	6	2	CTS41 RSE	3	6	190	0,73
150	F	CTS41	CTS4	9,4	94	94	6	2	CTS41 RSE	9,4	6	100	1,15
Rated voltage (+85°C) 10 V - Category voltage (+125°C) 6,3 V													
0,33	A		CTS4	1	1	-	6	10					
0,47*	A		CTS4	1	1	-	6	10					
2,2	B	CTS41	CTS4	1	2,2	2,2	6	10					
6,8	C	CTS41	CTS4	1	6,8	6,8	6	5	CTS41 RSE	1	6	500	0,35
22	D	CTS41	CTS4	2,2	22	22	6	5	CTS41 RSE	2,2	6	270	0,61
33	E	CTS41	CTS4	3,3	33	33	6	2	CTS41 RSE	3,3	6	220	0,67
100	F	CTS41	CTS4	10	100	100	6	2	CTS41 RSE	10	6	130	1,00
Rated voltage (+85°C) 16 V - Category voltage (+125°C) 10 V													
0,22	A		CTS4	1	1	-	6	-					
0,33*	A		CTS4	1	1	-	6	10					
1,5	B	CTS41	CTS4	1	2,4	2,4	6	10					
15	D	CTS41	CTS4	2,4	24	24	6	5	CTS41 RSE	2,4	6	330	0,55
22	E	CTS41	CTS4	3,5	35	35	6	2	CTS41 RSE	3,5	6	270	0,63
68	F	CTS41	CTS4	11	110	110	6	2	CTS41 RSE	11	6	130	0,90
Rated voltage (+85°C) 20 V - Category voltage (+125°C) 13 V													
0,1	A		CTS4	1	1	-	6	-					
0,15	A		CTS4	1	1	-	6	-					
0,22*	A		CTS4	1	1	-	6	-					
1	B	CTS41	CTS4	1	2	2	6	10					
3,3	C	CTS41	CTS4	1	6,6	6,6	6	5					
4,7	C	CTS41	CTS4	1	9,4	9,4	6	5	CTS41 RSE	1	6	600	0,32
6,8	D	CTS41	CTS4	1,4	14	14	6	5					
10	D	CTS41	CTS4	2	20	20	6	5	CTS41 RSE	2	6	400	0,48
15	E	CTS41	CTS4	3	30	30	6	2	CTS41 RSE	3	6	330	0,57
47	F	CTS41	CTS4	9,4	94	94	6	2	CTS41 RSE	9,4	6	190	0,82
Rated voltage (+85°C) 25 V - Category voltage (+125°C) 16 V													
0,68	B	CTS41	CTS4	1	1,7	1,7	6	10					
2,2	C	CTS41	CTS4	1	5,5	5,5	6	10					
6,8*	D	CTS41	CTS4	1,7	17	-	6	5					
10	E	CTS41	CTS4	2,5	25	25	6	2	CTS41 RSE	2,5	6	400	0,50
33	F	CTS41	CTS4	8,2	82	82	6	2	CTS41 RSE	8,2	6	220	0,76
Rated voltage (+85°C) 32 V - Category voltage (+125°C) 20 V													
0,47	B	CTS41	CTS4	1	1,5	1,5	6	10					
1,5	C	CTS41	CTS4	1	4,8	4,8	6	10					
4,7	D	CTS41	CTS4	1,5	15	15	6	5	CTS41 RSE	1,5	6	600	0,39
6,8	E	CTS41	CTS4	2,1	21	21	6	5	CTS41 RSE	2,1	6	500	0,45
22	F	CTS41	CTS4	7	70	70	6	2	CTS41 RSE	7	6	270	0,71
Rated voltage (+85°C) 40 V - Category voltage (+125°C) 25 V													
0,1*	B		CTS4	1	1	-	6	-					
0,15*	B		CTS4	1	1	-	6	-					
0,22*	B		CTS4	1	1	-	6	-					
0,33	B	CTS41	CTS4	1	1,3	1,3	6	10					
0,47*	B		CTS4	1	1,8	-	6	10					
0,68*	C		CTS4	1	2,7	-	6	10					
1*	C		CTS4	1	4	-	6	10					
1,5*	C		CTS4	1	6	-	6	5					
2,2*	D		CTS4	1	8,8	-	6	5					
3,3	D	CTS41	CTS4	1,3	13	13	6	5					

CTS41 - CTS4

CTS41 RSE

STANDARD RATINGS - ELECTRICAL CHARACTERISTICS

Capacitance 100Hz +20°C (μ F)	Case (code)	Type		Max. I leak			Max. DF +20°C (%)	Max. Impedance +20°C (Ω)	Type	Max. I leak +20°C (μ A)	Max. DF +20°C (%)	Max. ESR 100kHz +20°C (m Ω)	I _{rms} Max. +20°C (A)
				+20°C (μ A)	+85°C (μ A)	+125°C (μ A)							
Rated voltage (+85°C) 40 V - Category voltage (+125°C) 25 V													
4,7*	D		CTS4	1,8	18	-	6	5					
6,8*	E		CTS4	2,7	27	-	6	2					
10*	F		CTS4	4	40	-	6	2					
15	F	CTS41	CTS4	6	60	60	6	2	CTS41 RSE	6	6	330	0,63
Rated voltage (+85°C) 50 V - Category voltage (+125°C) 32 V													
0,1	B	CTS41	CTS4	1	1	1	6	-					
0,15	B	CTS41	CTS4	1	1	1	6	-					
0,22	B	CTS41	CTS4	1	1,1	1,1	6	-					
0,33*	C		CTS4	1	1,6	-	6	10					
0,47*	C		CTS4	1	2,3	-	6	10					
0,68*	C		CTS4	1	3,4	-	6	10					
1	C	CTS41	CTS4	1	5	5	6	10					
1,5	D	CTS41	CTS4	1	7,5	7,5	6	5					
2,2	D	CTS41	CTS4	1,1	11	11	6	5					
3,3	E	CTS41	CTS4	1,6	16	16	6	5					
4,7	E	CTS41	CTS4	2,3	23	23	6	5	CTS41 RSE	2,3	6	600	0,40
6,8	F	CTS41	CTS4	3,4	34	34	6	2	CTS41 RSE	3,4	6	500	0,50
10	F	CTS41	CTS4	5	50	50	6	2	CTS41 RSE	5	6	400	0,55
Rated voltage (+85°C) 63 V - Category voltage (+125°C) 40 V													
10	F		CTS4	2,5	25	25	6	2					

* out of CECC range

NOTES

Voltage and leakage current values at +125°C are not applicable for CTS4 type.

Rated voltage is not marked on the capacitors; in the event of two different voltages for a same capacitance value in a same case size, the higher voltage is identified by a color dot on the upper side of the capacitor (opposite side to the polarity mark).

Green = 50V

Yellow = 40V

Examples:

Case size F:

10 μ F - 40 V: no identification

10 μ F - 50 V: green dot

Case size B:

0,47 μ F - 32 V: no identification

0,47 μ F - 40 V: yellow dot

CTS27



Solid tantalum MnO₂ capacitors
Molded cases
Radial leads
 Polarized

ELECTRICAL AND CLIMATIC CHARACTERISTICS

	CTS27
Detail specification	According to CECC 30201-007
Operating temperature	-55°C +125°C
Damp heat	21 days
Capacitance range	0,1µF ⇔ 330µF
Tolerance	±10% - ±20%
Voltage range	6,3V ⇔ 50V
Max. capacitance change -55°C	-10%
Max. capacitance change +85°C	+12%
Max. capacitance change +125°C	+15%
Maximum DF at +20°C	see table
Maximum DF at -55°C	see table
Maximum DF at +85°C	see table
Maximum DF at +125°C	see table
Max. leakage current at +20°C	see table
Max. leakage current at +85°C	see table
Max. leakage current at +125°C	see table
Max. impedance (100kHz) +20°C	see table
High surge current	no
Max. Reverse voltage at +20°C	---
Max. Reverse voltage at +85°C	---
Max. Reverse voltage at +125°C	---
Max. surge voltage at +85°C	1,3 x U _R
Max. surge voltage at +125°C	1,3 x U _C

DIMENSIONS (mm)

Case code	Dimensions				
	L max	H max	E max	e ± 0,3	d +10%/- 0,05
A	4,7	7,3	4,2	2,5	0,5
B	7,3	10,5	4,8	5,0	0,5
C	12,3	10,5	7,3	10,16	0,6
D	12,3	10,5	12,3	10,16	0,6

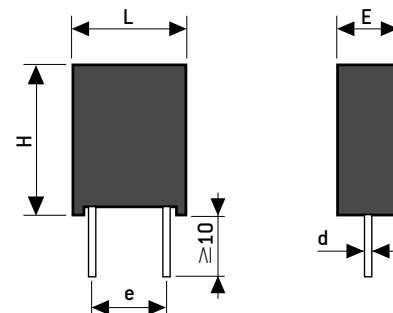

MARKING, PACKAGING, CONSTRUCTION:
 see general characteristics

HOW TO ORDER

Commercial description	Model	Case	Capacitance in µF	Tolerance in %	DC Voltage	Termination	
	CTS27	D	68µF	20%	25V	H	
EXXELIA PN	Model code	Case	Capacitance code	Tolerance code	DC Voltage code	Termination	
	TS27	D	686	M	025	A	
			Expressed in pF with 3 digits: 2 digits for the value and the third for the multiplier	K = 10% M = 20%	Expressed in volt with 3 digits	Commercial description H = SnPb (non RoHS) - = Sn100% (RoHS)	EXXELIA PN A = SnPb (non RoHS) F = Sn100% (RoHS)

CTS27

STANDARD RATINGS - ELECTRICAL CHARACTERISTICS

Capacitance 100Hz +20°C (μF)	Case (code)	Type	Max. leakage current			Max. DF				Max. Impedance +20°C (Ω)
			+20°C (μA)	+85°C (μA)	+125°C (μA)	-55°C (%)	+20°C (%)	+85°C (%)	+125°C (%)	
Rated voltage (+85°C) 6,3 V - Category voltage (+125°C) 4 V										
6,8	A	CTS27	1	4,2	4,3	9	6	9	12	10
47	B	CTS27	2,9	29	36,2	9	6	9	12	2
150	C	CTS27	9,4	94	117	9	6	9	12	2
330	D	CTS27	20,8	208	260	11	8	11	14	1
Rated voltage (+85°C) 10 V - Category voltage (+125°C) 6,3 V										
4,7	A	CTS27	1	4,7	5,8	9	6	9	12	10
33	B	CTS27	3,3	33	41,2	9	6	9	12	2
100	C	CTS27	10	100	125	9	6	9	12	2
220	D	CTS27	22	220	275	11	8	11	14	1
Rated voltage (+85°C) 16 V - Category voltage (+125°C) 10 V										
2,2	A	CTS27	1	3,5	4,4	9	6	9	12	10
3,3	A	CTS27	1	5,2	6,6	9	6	9	12	10
15	B	CTS27	2,4	24	30	9	6	9	12	5
22	B	CTS27	3,5	35	43,7	9	6	9	12	2
47	C	CTS27	7,5	75	93,7	9	6	9	12	2
68	C	CTS27	10,8	108	135	9	6	9	12	2
100	D	CTS27	16	160	200	9	6	9	12	1
150	D	CTS27	24	240	300	11	8	11	14	1
Rated voltage (+85°C) 25 V - Category voltage (+125°C) 16 V										
1,5	A	CTS27	1	3,7	4,6	9	6	9	12	10
10	B	CTS27	2,5	25	31,2	9	6	9	12	2
33	C	CTS27	8,2	82	102	9	6	9	12	2
68	D	CTS27	17	170	212	9	6	9	12	1
Rated voltage (+85°C) 40 V - Category voltage (+125°C) 25 V										
0,1*	A	CTS27	1	1	1	9	6	9	12	-
0,15*	A	CTS27	1	1	1	9	6	9	12	-
0,22*	A	CTS27	1	1	1,1	9	6	9	12	-
0,33*	A	CTS27	1	1,3	1,6	9	6	9	12	10
0,47*	A	CTS27	1	1,8	2,3	9	6	9	12	10
0,68*	A	CTS27	1	2,7	3,4	9	6	9	12	10
1	A	CTS27	1	4	5	9	6	9	12	10
1,5	B	CTS27	1	6	7,5	9	6	9	12	5
2,2	B	CTS27	1	8,8	11	9	6	9	12	5
3,3	B	CTS27	1,3	13	16,2	9	6	9	12	5
4,7	B	CTS27	1,8	18	22,5	9	6	9	12	5
6,8	B	CTS27	2,7	27	33,7	9	6	9	12	2
10	C	CTS27	4	40	50	9	6	9	12	2
15	C	CTS27	6	60	75	9	6	9	12	2
22	C	CTS27	8,8	88	110	9	6	9	12	2
33	D	CTS27	13,2	132	165	9	6	9	12	1
47	D	CTS27	18,8	188	235	9	6	9	12	1
Rated voltage (+85°C) 50 V - Category voltage (+125°C) 32 V										
0,1*	A	CTS27	1	1	1	9	6	9	12	-
0,15*	A	CTS27	1	1	1	9	6	9	12	-
0,22*	A	CTS27	1	1,1	1,3	9	6	9	12	-
0,33*	A	CTS27	1	1,6	2	9	6	9	12	10
0,47*	B	CTS27	1	2,3	2,9	9	6	9	12	10
0,68*	B	CTS27	1	3,4	4,2	9	6	9	12	10
1*	B	CTS27	1	5	6,2	9	6	9	12	10
1,5*	B	CTS27	1	7,5	9,3	9	6	9	12	5
2,2*	B	CTS27	1,1	11	13,7	9	6	9	12	5
3,3*	B	CTS27	1,7	17	20,6	9	6	9	12	5
4,7*	B	CTS27	2,3	23	29	9	6	9	12	5
6,8*	C	CTS27	3,4	34	42	9	6	9	12	2
10*	C	CTS27	5	50	62	9	6	9	12	2
15*	C	CTS27	7,5	75	93	9	6	9	12	2
22*	D	CTS27	11	110	137	9	6	9	12	1

* out of CECC range

SMD - General characteristics

Applicable for types see below:

General purpose: CTC3, CTC3E, CTC23

Special for power supplies and converters: CTC4, CTC21, CTC21E, CTC42, CTC42E, SMT47

CONSTRUCTION

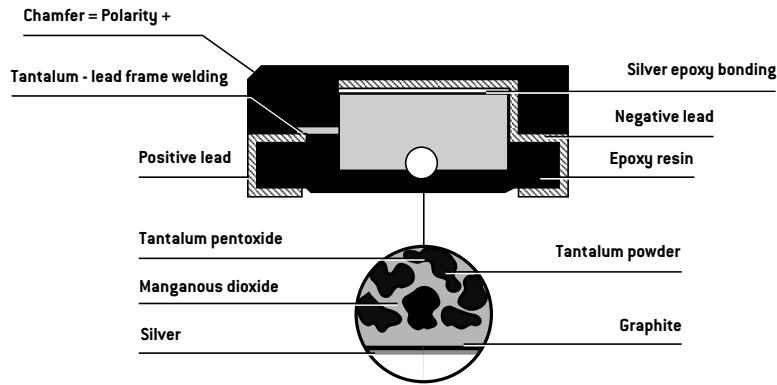

MARKING CTC3 - CTC3E - CTC4 - CTC4 RSE



MARKING CAPACITANCE CODING

Code	C (μF)	Code	C (μF)	Code	C (μF)	Code	C (μF)
104	0,1	105	1,0	106	10	107	100
154	0,15	155	1,5	156	15	157	150
224	0,22	225	2,2	226	22	↓	↓
334	0,33	335	3,3	336	33	108	1000
474	0,47	475	4,7	476	47		
684	0,68	685	6,8	686	68		

PACKAGING

CTC3, CTC3E, CTC4, CTC4 RSE: on tape (see next page)

CTC21, CTC21E, CTC23, SMT47: boxes or plastic bags or on tape (see datasheet)

CTC42, CTC42E: boxes or plastic bags

SMD - General characteristics

CTC21, CTC21E, CTC3, CTC4, CTC3E, CTC4 RSE, CTC23, CTC42, CTC42E, SMT47:
vapour phase or infrared (see temperature profiles below) and soldering iron.

CTC3, CTC4, CTC3E, CTC4 RSE:

Double-Wave-Soldering (see temperature profiles below)

VAPOR PHASE SOLDERING, BATCH SYSTEM WITH PREHEATING:

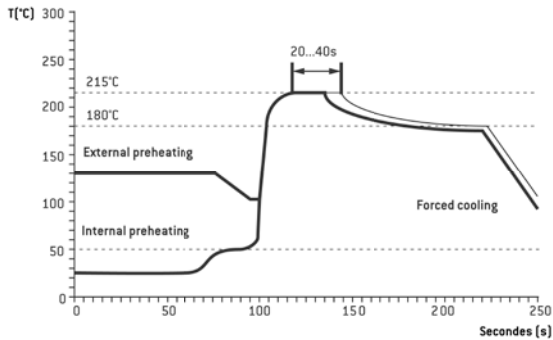

VAPOR PHASE SOLDERING, IN-LINE SYSTEM WITH PREHEATING:

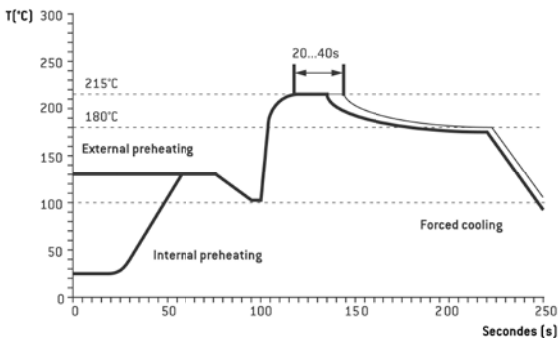

INFRARED SOLDERING:

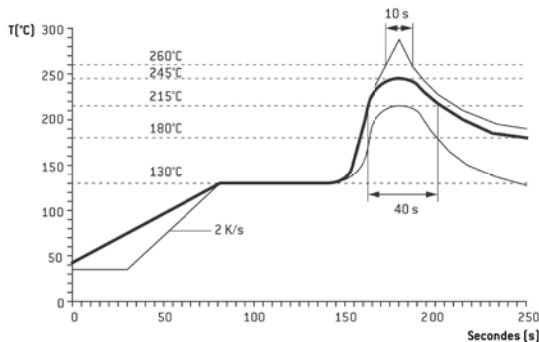

DOUBLE-WAVE-SOLDERING:

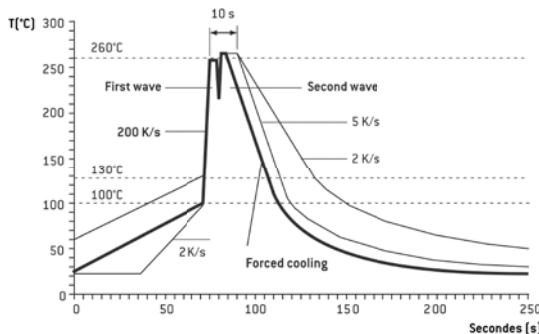

Bold line : preferred temperature/time profile

Fine line : temperature/time profile limit

ATTENTION

For models CTC21, CTC21E, CTC23, CTC42 and CTC42E, SMT47 for which the nominal voltage (U_R) is ≥ 40 volts; due to their substantial volume and the thermo-mechanical constraints brought about during the soldering of circuits by the method "infrared forced convection", we advise as far as it is possible by the design of the board to make this soldering manually using a soldering iron.

Numerous experiments demonstrate that this solution although difficult to control gives very good results compared with the above-mentioned automated method.

For soldering ovens using "infrared forced convection", their mode of operation depends on the coefficient of absorption of the surface of the material and the thermal mass of the various components subjected to the infrared radiation.

The temperature of the various components under these conditions is not easily managed or controlled during the passage through the oven. For some components, temperatures within the components were found to be much more than 15°C higher than the external temperatures.

The parameters which affect the temperature of components are:

- Time and power
- Mass of the component
- Size of the component
- Dimension of the circuit
- Coefficient of absorption of the surfaces
- Density of components
- Wavelength of radiation of the source
- Relation between energy of radiation and energy of convection

The standard profile of this process is given on the previous page and comes from the CECC standard 00802.

A period of pre-heating is necessary to allow the evacuation of solvents contained in solder flux before starting the flux "wetting".

ADVICE

- Preheat the board (to eliminate the tracks of humidity) before the application of the solder flux. 4 hours minimum in +70 °C.
- In the case of a double-sided board, not to clean after the first passage. It could result in a higher level of humidity which could affect the quality of the soldering during the second passage.
- A minimum solder joint is preferable. The solder does not have to run up too high up the connections.
- Good solder joints are realised with connections having a good solderability (check the angle of wetting).
- The mechanical adhesion of the component on the board is best assured when the connecting pad is directly in contact with the board.

SMD - General characteristics

RECOMMENDED MOUNTING PAD GEOMETRY CTC21, CTC21E, CTC23, CTC42, CTC42E, SMT47

VAPOR PHASE OR INFRARED SOLDERING (in mm)

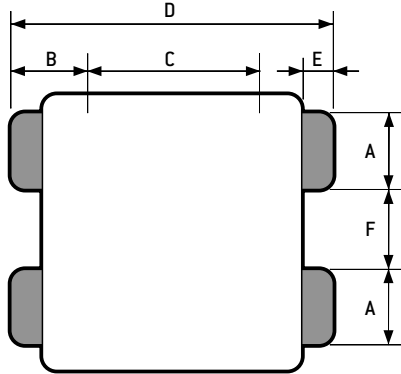

Case code	Dimensions (mm)					
	A min.	B nom.	C nom.	D nom.	E nom.	F nom.
C	2,6	3,3	7,6	14,2	1,35	2,3
D	3,6	3,3	7,6	14,2	1,35	3,8

RECOMMENDED MOUNTING PAD GEOMETRY CTC3, CTC3E, CTC3E Low Profile, CTC4, CTC4 RSE

VAPOR PHASE OR INFRARED SOLDERING (in mm)

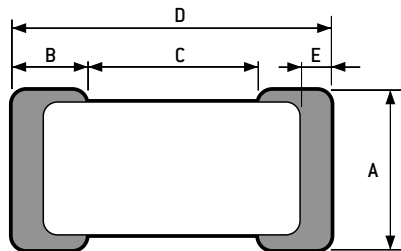

Case code	Dimensions (mm)				
	A min.	B nom.	C nom.	D nom.	E nom.
A	1,80	2,15	1,35	5,65	1,23
B	2,80	2,15	1,65	5,95	1,23
C	2,80	2,70	3,15	8,55	1,28
V/D/E	3,00	2,70	4,45	9,85	1,28

WAVE SOLDERING (in mm)

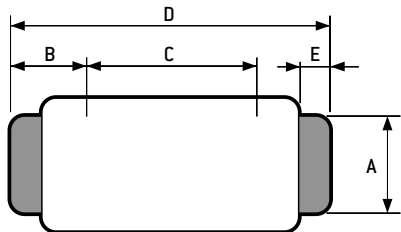

Case code	Dimensions (mm)				
	A min.	B nom.	C nom.	D nom.	E nom.
A	0,87	2,15	1,35	5,65	1,23
B	1,54	2,15	1,65	5,95	1,23
C	1,54	2,70	3,15	8,55	1,28
V/D/E	1,68	2,70	4,45	9,85	1,28

CTC3 - CTC4 CTC3E

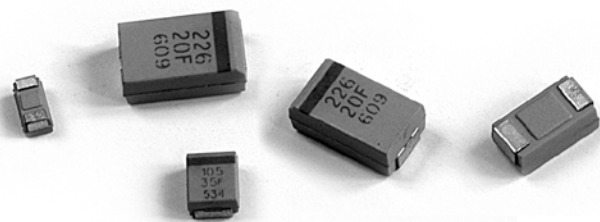
Solid tantalum MnO₂ capacitors**Molded cases****SMD**

100% Tin (Sn) plated

Polarized

ELECTRICAL AND CLIMATIC CHARACTERISTICS

	CTC3	CTC4	CTC3E
Operating temperature	-55°C +125°C	-55°C +125°C	-55°C +125°C
Damp heat	56 days	56 days	56 days
Capacitance range	0,1µF ⇒ 150µF	0,1µF ⇒ 100µF	0,15µF ⇒ 680µF
Tolerance	±10% - ±20%	±10% - ±20%	±10% - ±20%
Voltage range	4V ⇒ 50V	4V ⇒ 50V	4V ⇒ 50V
Max. capacitance change -55°C	-10%	-10%	-10%
Max. capacitance change +85°C	+10%	+10%	+10%
Max. capacitance change +125°C	+12%	+12%	+15%
Maximum DF at +20°C	see table	see table	see table
Maximum DF at -55°C	= 1,5 x lim20°C	= 1,5 x lim20°C	see table
Maximum DF at +85°C	= 1,5 x lim20°C	= 1,5 x lim20°C	see table
Maximum DF at +125°C	= 2,0 x lim20°C	= 2,0 x lim20°C	see table
Max. leakage current at +20°C	see table	see table	see table
Max. leakage current at +85°C	see table	see table	see table
Max. leakage current at +125°C	see table	see table	see table
Max. ESR at 100kHz +20°C	---	see table	see table
Max. impedance (100kHz) +20°C	see table	---	---
Max. ripple current 100kHz +20°C	---	see table	---
High surge current	non / no	1 million cycles	non / no
Max. Reverse voltage at +20°C	15 % U _R	15 % U _R	15 % U _R
Max. Reverse voltage at +85°C	5 % U _R	5 % U _R	5 % U _R
Max. Reverse voltage at +125°C	1 % U _R	1 % U _R	1 % U _R
Max. surge voltage at +85°C	1,3 x U _R	1,3 x U _R	1,3 x U _R
Max. surge voltage at +125°C	1,3 x U _C	1,3 x U _C	1,3 x U _C

DIMENSIONS (mm)

Case code	Dimensions					
	L	W	H	P	Tw	Th min.
A	3,2±0,2	1,6±0,2	1,6±0,2	0,8±0,3	1,2±0,1	0,7
B	3,5±0,2	2,8±0,2	1,9±0,2	0,8±0,3	2,2±0,1	0,7
C	6,0±0,3	3,2±0,3	2,5±0,3	1,3±0,3	2,2±0,1	1,0
D	7,3±0,3	4,3±0,3	2,8±0,3	1,3±0,3	2,4±0,1	1,0

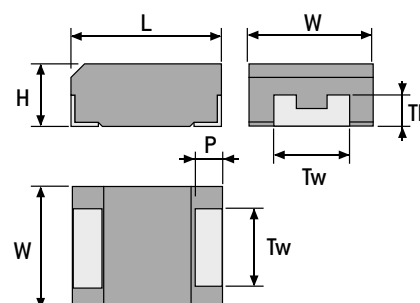

MARKING, PACKAGING, CONSTRUCTION:

see general characteristics

HOW TO ORDER

Commercial description	Model			Case	Capacitance in µF	Tolerance in %	DC Voltage	Termination (RoHS)
	CTC3	CTC4	CTC3E					
				D	33µF	20%	16V	-
EXXELIA PN	Model code			Case	Capacitance code	Tolerance code	DC Voltage code	Termination (RoHS)
	TS83	TS84	TS83E	D	336	M	016	F

Expressed in pF with 3 digits: 2 digits for the value and the third for the multiplier

K = 10%
M = 20%

Expressed in volt with 3 digits

Commercial description
- = Sn100% (RoHS)EXXELIA PN
F = Sn100% (RoHS)

(Standard range)

CTC3
CTC4

STANDARD RATINGS - ELECTRICAL CHARACTERISTICS

Capacitance 100kHz +20°C (μF)	Case (code)	Type	Max. I leak			Max. DF +20°C (%)	Max. Impedance +20°C (Ω)	Type	Max. ESR 100kHz +20°C (Ω)	I _{rms} Max. +20°C (mA)
			+20°C (μA)	+85°C (μA)	+125°C (μA)					
Rated voltage (+85°C) 4 V - Category voltage (+125°C) 2,5 V										
3,3	A	CTC3	0,5	5	6,2	6	9	CTC4	9,0	88
4,7	A	CTC3	0,5	5	6,2	6	8	CTC4	7,5	97
10	B	CTC3	0,5	5	6,2	6	4,5	CTC4	4,0	140
15*	A	CTC3	0,6	6	7,5	6	4			
15	B	CTC3	0,6	6	7,5	6	3,5	CTC4	3,5	150
22	C	CTC3	0,9	9	11	6	3	CTC4	2,2	224
33*	B	CTC3	1,3	13	16	6	3,5			
33	C	CTC3	1,3	13	16	6	2,5	CTC4	1,8	247
68*	C	CTC3	2,7	27	34	6	1,6			
68	D	CTC3	2,7	27	34	6	1,8	CTC4	1,0	387
100	D	CTC3	4	40	50	8	1,5	CTC4	0,8	433
Rated voltage (+85°C) 6,3 V - Category voltage (+125°C) 4 V										
2,2	A	CTC3	0,5	5	6,2	6	10	CTC4	9,0	88
3,3	A	CTC3	0,5	5	6,2	6	7	CTC4	7,5	97
6,8	B	CTC3	0,5	5	6,2	6	4,5	CTC4	4,0	140
10*	A	CTC3	0,6	6	7,5	6	4			
10	B	CTC3	0,6	6	7,5	6	3,5	CTC4	3,5	150
15	C	CTC3	0,9	9	11	6	3	CTC4	2,0	234
22*	B	CTC3	1,3	13	17	6	3,5			
22	C	CTC3	1,3	13	17	6	2,5	CTC4	1,8	247
47*	C	CTC3	2,9	29,6	37	6	1,6			
47	D	CTC3	2,9	29,6	37	6	1,8	CTC4	1,1	365
68	D	CTC3	4	40	50	6	1,5	CTC4	0,9	408
100*	D	CTC3	6,3	63	78,7	8	1,5	CTC4	0,8	433
150	D	CTC3	9,4	94,5	118	8	0,7			
Rated voltage (+85°C) 10 V - Category voltage (+125°C) 6,3 V										
1,5	A	CTC3	0,5	5	6,2	6	10,5	CTC4	8,0	94
2,2	A	CTC3	0,5	5	6,2	6	7	CTC4	7,5	97
4,7	B	CTC3	0,5	5	6,2	6	4,5	CTC4	4,0	140
6,8	B	CTC3	0,6	6,8	8,5	6	3,5	CTC4	3,5	150
10	C	CTC3	1	10	12	6	3	CTC4	2,0	234
15*	B	CTC3	1,5	15	18,7	6	3,5			
15	C	CTC3	1,5	15	18,7	6	2,5	CTC4	1,8	247
33*	C	CTC3	3	30	37	6	1,6			
33	D	CTC3	3	30	37	6	1,8	CTC4	0,9	408
47	D	CTC3	4,7	47	58,7	6	1,5	CTC4	0,8	433
68*	D	CTC3	6,8	68	85	6	0,8			
100*	D	CTC3	10	100	125	8	0,7			
Rated voltage (+85°C) 16 V - Category voltage (+125°C) 10 V										
1	A	CTC3	0,5	5	6,2	4	11	CTC4	10,0	84
1,5	A	CTC3	0,5	5	6,2	6	8	CTC4	8,0	94
3,3*	A	CTC3	0,5	5	6,2	6	6			
3,3	B	CTC3	0,5	5	6,2	6	5	CTC4	4,0	140
4,7	B	CTC3	0,7	7,5	9,4	6	3,5	CTC4	3,5	150
6,8*	B	CTC3	1,1	11	14	6	3,5			
6,8	C	CTC3	1,1	11	14	6	3	CTC4	1,9	240
10*	B	CTC3	1,6	16	20	6	3,5			
10	C	CTC3	1,6	16	20	6	2,5	CTC4	1,8	247
15*	C	CTC3	2,4	24	30	6	1,8			
22*	C	CTC3	3,5	35	44	6	1,6			
22	D	CTC3	3,5	35	44	6	1,8	CTC4	0,9	408
33	D	CTC3	5	50	62	6	1,5	CTC4	0,8	433
47*	D	CTC3	7,5	75	94	6	0,8			

* out of CECC range

CTC3 CTC4

(Standard range)

STANDARD RATINGS - ELECTRICAL CHARACTERISTICS

Capacitance 100Hz +20°C (μF)	Case (code)	Type	Max. I leak			Max. DF +20°C (%)	Max. Impedance +20°C (Ω)	Type	Max. ESR 100kHz +20°C (Ω)	I _{rms} Max. +20°C (mA)
			+20°C (μA)	+85°C (μA)	+125°C (μA)					
Rated voltage (+85°C) 20 V - Category voltage (+125°C) 13 V										
0,68	A	CTC3	0,5	5	6,2	4	13	CTC4	12,0	76
1	A	CTC3	0,5	5	6,2	4	9	CTC4	10,0	84
1,5*	A	CTC3	0,5	5	6,2	6	8			
2,2*	A	CTC3	0,5	5	6,2	6	7			
2,2	B	CTC3	0,5	5	6,2	6	6	CTC4	3,5	150
3,3	B	CTC3	0,7	7	8,5	6	4,5	CTC4	3,5	150
4,7*	B	CTC3	0,9	9	11	6	3,5			
4,7	C	CTC3	0,9	9	11	6	3	CTC4	2,4	214
6,8	C	CTC3	1,3	13,6	17	6	2,5	CTC4	1,9	240
10*	C	CTC3	2	20	25	6	1,8			
15	D	CTC3	3	30	37	6	1,8	CTC4	1,0	387
22	D	CTC3	4,4	44	55	6	1,5	CTC4	0,8	433
33*	D	CTC3	6,6	66	82,5	6	0,9			
Rated voltage (+85°C) 25 V - Category voltage (+125°C) 16 V										
0,47	A	CTC3	0,5	5	6,2	4	14	CTC4	14,0	71
0,68	A	CTC3	0,5	5	6,2	4	10	CTC4	10,0	84
1,5	B	CTC3	0,5	5	6,2	6	7	CTC4	5,0	120
3,3	C	CTC3	0,8	8	10	6	3,5	CTC4	2,5	209
4,7	C	CTC3	1,1	11,7	14,6	6	2,8	CTC4	2,4	214
6,8*	C	CTC3	1,7	17	21,2	6	1,9			
10	D	CTC3	2,5	25	31	6	2	CTC4	1,2	350
15	D	CTC3	3,7	37,5	46,8	6	1,5	CTC4	1,0	387
22*	D	CTC3	5,5	55	68,7	6	0,9			
Rated voltage (+85°C) 35 V - Category voltage (+125°C) 23 V										
0,1	A	CTC3	0,5	5	6,2	4	28	CTC4	20,0	54
0,15	A	CTC3	0,5	5	6,2	4	23	CTC4	19,0	58
0,22	A	CTC3	0,5	5	6,2	4	19	CTC4	18,0	62
0,33	A	CTC3	0,5	5	6,2	4	15	CTC4	15,0	68
0,47	B	CTC3	0,5	5	6,2	4	11	CTC4	8,0	89
0,68	B	CTC3	0,5	5	6,2	4	8	CTC4	6,5	100
1	B	CTC3	0,5	5	6,2	4	7	CTC4	5,0	110
1,5	C	CTC3	0,5	5	6,3	6	6	CTC4	4,5	156
2,2	C	CTC3	0,7	7,7	9,6	6	4	CTC4	3,5	177
3,3	C	CTC3	1,1	11,5	14,4	6	3	CTC4	2,5	210
4,7	D	CTC3	1,6	16	20	6	2,5	CTC4	1,5	315
6,8	D	CTC3	2,3	23,8	29,7	6	2	CTC4	1,3	340
10	D	CTC3	3,5	35	43,7	6	1,5	CTC4	1,0	387
Rated voltage (+85°C) 50 V - Category voltage (+125°C) 33 V										
0,1	A	CTC3	0,5	5	6,2	4	27	CTC4	20,0	56
0,15	B	CTC3	0,5	5	6,2	4	22	CTC4	16,0	69
0,22	B	CTC3	0,5	5	6,2	4	18	CTC4	14,0	76
0,33	B	CTC3	0,5	5	6,2	4	14	CTC4	10,0	82
0,47	C	CTC3	0,5	5	6,2	4	9	CTC4	8,0	117
0,68	C	CTC3	0,5	5	6,2	4	7	CTC4	7,0	125
1	C	CTC3	0,5	5	6,2	4	6	CTC4	5,5	140
1,5	D	CTC3	0,7	7,5	9,3	6	5	CTC4	3,5	195
2,2	D	CTC3	1,1	11	13,7	6	3,5	CTC4	2,5	250
3,3	D	CTC3	1,6	16,5	20,6	6	2	CTC4	2,0	274
4,7	D	CTC3	2,3	23,5	29,3	6	1,5	CTC4	1,4	327

* out of CECC range

(Extended range)

CTC3E

STANDARD RATINGS - ELECTRICAL CHARACTERISTICS

Capacitance 100Hz +20°C (μF)	Case (code)	Type	Max. I leak			Max. DF			Max. ESR 100kHz +20°C (Ω)	
			+20°C (μA)	+85°C (μA)	+125°C (μA)	-55°C (%)	+20°C (%)	+85°C (%)		+125°C (%)
Rated voltage (+85°C) 4 V - Category voltage (+125°C) 2,5 V										
33	A	CTC3E	1,3	13,2	16,5	9	6	9	12	4,0
47	A	CTC3E	1,9	19	24	18	12	18	24	2,5
68	A	CTC3E	2,7	27,2	34	45	30	45	60	4,0
68	B	CTC3E	2,7	27,2	34	9	6	9	12	3,5
100	C	CTC3E	4,0	40	50	45	30	45	60	4,0
150	B	CTC3E	6,0	60	75	18	12	18	24	2,0
150	C	CTC3E	6,0	60	75	12	8	12	16	1,2
220	B	CTC3E	8,8	88	110	27	18	27	36	0,5
220	C	CTC3E	8,8	88	110	22	15	22	30	1,2
330	D	CTC3E	13,2	132	165	15	10	15	20	1,2
470	D	CTC3E	18,8	188	235	12	8	12	16	0,8
680	D	CTC3E	27,2	272	340	18	12	18	24	0,5
Rated voltage (+85°C) 6,3 V - Category voltage (+125°C) 4 V										
15	A	CTC3E	0,9	9,4	11,8	9	6	9	12	4,0
22	A	CTC3E	1,4	13,9	17,3	9	6	9	12	4,0
33	A	CTC3E	2,0	20	25	18	12	18	24	2,5
47	A	CTC3E	2,9	29	36,2	9	6	9	12	1,6
47	B	CTC3E	2,9	29	37	9	6	9	12	3,5
68	B	CTC3E	4,1	41	51,2	12	8	12	16	1,0
100	B	CTC3E	6,3	63	78,7	22,5	15	22,5	30	3,0
100	C	CTC3E	6,3	63	78,7	12	8	12	15	1,2
150	B	CTC3E	9,5	95	119	22,5	15	22,5	30	3,0
220	C	CTC3E	13,2	132	165	15	10	15	20	1,2
330	D	CTC3E	19,8	198	247	12	8	12	15	0,5
470	D	CTC3E	28,2	282	352,5	18	12	18	24	0,5
Rated voltage (+85°C) 10 V - Category voltage (+125°C) 6,3 V										
6,8	A	CTC3E	0,6	6,8	8,5	9	6	9	12	6,0
10	A	CTC3E	1,0	10	12,5	9	6	9	12	4,0
15	A	CTC3E	1,5	15	18,7	12	8	12	16	6,0
22	A	CTC3E	2,2	22	27,5	15	10	15	20	6,0
22	B	CTC3E	2,2	22	27,5	9	6	9	12	3,0
33	A	CTC3E	3,3	33	41,5	22,5	15	22,5	30	6,0
33	B	CTC3E	3,3	33	41,2	9	6	9	12	3,5
47	B	CTC3E	4,7	47	58,7	12	8	12	16	1,0
47	C	CTC3E	4,7	47	58,7	9	6	9	12	1,2
68	B	CTC3E	6,8	68	85	15	10	15	20	3,0
68	C	CTC3E	6,8	68	85	9	6	9	12	1,2
100	C	CTC3E	10,0	100	125	12	8	12	16	1,2
100	D	CTC3E	10,0	100	125	12	8	12	16	1,2
150	C	CTC3E	15,0	150	187,5	15	10	15	20	1,2
150	D	CTC3E	15,0	150	187,5	12	8	12	15	0,7
220	D	CTC3E	22,0	220	275	12	8	12	15	0,5
330	D	CTC3E	33,0	330	412,5	15	10	15	20	0,5
Rated voltage (+85°C) 16 V - Category voltage (+125°C) 10 V										
4,7	A	CTC3E	0,7	7,5	9,4	9	6	9	12	6,0
6,8	A	CTC3E	1,1	11	13,7	9	6	9	12	7,0
10	B	CTC3E	1,6	16	20	15	10	15	20	7,0
15	B	CTC3E	2,4	24	30	9	6	9	12	3,0
22	B	CTC3E	3,6	36	45	9	6	9	12	2,2
33	C	CTC3E	5,3	53	66	9	6	9	12	1,2
47	C	CTC3E	7,5	75	93,7	9	6	9	12	1,2
68	D	CTC3E	10,9	109	136	9	6	9	12	0,7
100	D	CTC3E	16,0	160	200	12	8	12	15	0,7
150	D	CTC3E	24,0	240	300	18	12	18	24	0,7

CTC3E

[Extended range]

STANDARD RATINGS - ELECTRICAL CHARACTERISTICS

Capacitance 100Hz +20°C (μ F)	Case (code)	Type	Max. I leak			Max. DF				Max. ESR 100kHz +20°C (Ω)
			+20°C (μ A)	+85°C (μ A)	+125°C (μ A)	-55°C (%)	+20°C (%)	+85°C (%)	+125°C (%)	
Rated voltage / Tension nominale (+85°C) 20 V - Category voltage / Tension de catégorie (+125°C) 13 V										
3,3	A	CTC3E	0,7	6,6	8,2	9	6	9	12	7,0
4,7	A	CTC3E	1,0	10	12,5	12	8	12	16	6,0
6,8	A	CTC3E	1,4	14	17,5	12	8	12	16	6,0
6,8	B	CTC3E	1,3	13,6	17	9	6	9	12	3,5
10	A	CTC3E	2,0	20	25	15	10	15	20	5,0
10	B	CTC3E	2,0	20	25	9	6	9	12	3,0
15	B	CTC3E	3,0	30	37,5	9	6	9	12	2,5
15	C	CTC3E	3,0	30	37,5	9	6	9	12	1,7
22	B	CTC3E	4,4	44	55	12	8	12	16	4,0
22	C	CTC3E	4,4	44	55	9	6	9	12	1,2
33	B	CTC3E	6,6	66	82,5	15	10	15	20	4,0
33	C	CTC3E	6,6	66	82,5	9	6	9	12	1,2
47	C	CTC3E	9,4	94	117,5	15	10	15	20	0,9
47	D	CTC3E	9,4	94	117,5	9	6	9	12	0,7
68	D	CTC3E	13,6	136	170	12	8	12	16	0,7
Rated voltage / Tension nominale (+85°C) 25 V - Category voltage / Tension de catégorie (+125°C) 16 V										
1,5	A	CTC3E	0,5	5	6,2	9	6	9	12	10,0
2,2	A	CTC3E	0,5	5,5	6,8	9	6	9	12	7,0
2,2	B	CTC3E	0,5	5,5	6,8	9	6	9	12	4,5
3,3	A	CTC3E	0,9	8,3	10,3	9	6	9	12	7,0
3,3	B	CTC3E	0,9	8,3	10,3	9	6	9	12	3,5
4,7	A	CTC3E	1,2	12	15	12	8	12	16	6,0
4,7	B	CTC3E	1,2	12	15	9	6	9	12	1,5
6,8	B	CTC3E	1,7	17	21,2	12	8	12	16	3,0
10	B	CTC3E	2,5	25	31,2	12	8	12	16	3,0
10	C	CTC3E	2,5	25	31,2	9	6	9	12	1,5
15	B	CTC3E	3,8	38	47,5	12	8	12	16	4,0
15	C	CTC3E	3,8	38	47,5	9	6	9	12	1,5
22	C	CTC3E	5,5	55	68,7	12	8	12	16	1,5
33	C	CTC3E	8,3	83	103,7	15	10	15	20	1,2
33	D	CTC3E	8,3	83	103,7	9	6	9	12	0,7
47	D	CTC3E	11,8	118	147,5	15	10	15	20	0,7
68	D	CTC3E	17	170	212,5	15	10	15	20	0,7
Rated voltage / Tension nominale (+85°C) 35 V - Category voltage / Tension de catégorie (+125°C) 23 V										
0,47	A	CTC3E	0,5	5	6,2	6	4	6	9	14,0
0,68	A	CTC3E	0,5	5	6,2	6	4	6	9	10,0
1	A	CTC3E	0,5	5	6,2	6	4	6	9	10,0
1,5	B	CTC3E	0,5	5,2	6,6	9	6	9	12	5,0
2,2	B	CTC3E	0,8	7,7	9,6	9	6	9	12	4,0
3,3	B	CTC3E	1,2	12	15	9	6	9	12	3,5
4,7	C	CTC3E	1,6	16,4	20,5	9	6	9	12	2,5
6,8	C	CTC3E	2,4	24	29,7	9	6	9	12	2,0
10	C	CTC3E	3,5	35	43,7	9	6	9	12	2,0
15	D	CTC3E	5,3	52,5	65,6	9	6	9	12	0,8
22	D	CTC3E	7,7	77	96,2	9	6	9	12	0,7
Rated voltage / Tension nominale (+85°C) 50 V - Category voltage / Tension de catégorie (+125°C) 33 V										
0,15	A	CTC3E	0,5	5	6,2	6	4	6	9	19,0
0,47	B	CTC3E	0,5	5	6,2	6	4	6	9	9,0
0,68	B	CTC3E	0,5	5	6,2	6	4	6	9	8,0
1,5	C	CTC3E	0,7	7,5	9,3	9	6	9	12	4,5
2,2	C	CTC3E	1,1	11	13,7	9	6	9	12	3,5
6,8	D	CTC3E	3,4	34	42,5	9	6	9	12	1,0

[Low profile]

CTC3E

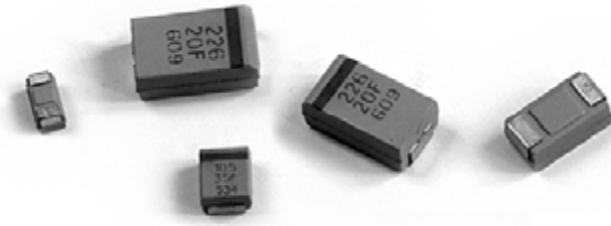

Solid tantalum MnO₂ capacitors
Molded cases - Low profile
SMD
 100% Tin [Sn] plated
 Polarized

ELECTRICAL AND CLIMATIC CHARACTERISTICS

	CTC3E
Operating temperature	-55°C +125°C
Damp heat	56 days
Capacitance range	1µF ⇒ 330µF
Tolerance	±10% - ±20%
Voltage range	4V ⇒ 50V
Max. capacitance change -55°C	-10%
Max. capacitance change +85°C	+10%
Max. capacitance change +125°C	+15%
Maximum DF at +20°C	see table
Maximum DF at -55°C	see table
Maximum DF at +85°C	see table
Maximum DF at +125°C	see table
Max. leakage current at +20°C	see table
Max. leakage current at +85°C	see table
Max. leakage current at +125°C	see table
Max. ESR at 100kHz +20°C	see table
High surge current	non / no
Max. Reverse voltage at +20°C	15 % U _R
Max. Reverse voltage at +85°C	5 % U _R
Max. Reverse voltage at +125°C	1 % U _R
Max. surge voltage at +85°C	1,3 x U _R
Max. surge voltage at +125°C	1,3 x U _C

DIMENSIONS (mm)

Case code	Dimensions					
	L	W	H	P	Tw	Th min.
S	3,2±0,2	1,6±0,2	1,2±0,2	0,8±0,2	1,2±0,1	0,3
T	3,5±0,2	2,8±0,2	1,2±0,2	0,8±0,3	2,2±0,1	0,3
U	6,0±0,3	3,2±0,3	1,5±0,3	1,3±0,3	2,2±0,1	0,5
V	7,3±0,3	4,3±0,3	2,0±0,3	1,3±0,3	2,4±0,1	1,1

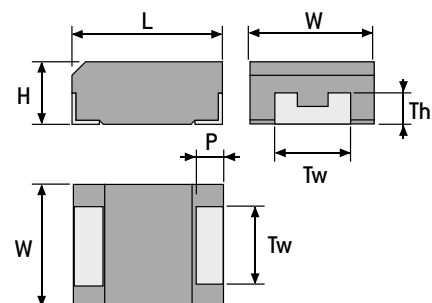

MARKING, PACKAGING, CONSTRUCTION:
 see general characteristics

HOW TO ORDER

Commercial description	Model	Case	Capacitance in µF	Tolerance in %	DC Voltage	Termination (RoHS)
	CTC3E	V	33µF	20%	20V	-
EXXELIA PN	Model code	Case	Capacitance code	Tolerance code	DC Voltage code	Termination (RoHS)
	TS83E	V	336	M	020	F

Expressed in pF with 3 digits: 2 digits for the value and the third for the multiplier

K = 10%
 M = 20%

Expressed in volt with 3 digits

Commercial description
 - = Sn100% (RoHS) **EXXELIA PN**
 F = Sn100% (RoHS)

CTC3E**(Low profile)****STANDARD RATINGS - ELECTRICAL CHARACTERISTICS**

Capacitance 100Hz +20°C (µF)	Case (code)	Type	Max. I leak			Max. DF				Max. ESR 100kHz +20°C (Ω)
			+20°C (µA)	+85°C (µA)	+125°C (µA)	-55°C (%)	+20°C (%)	+85°C (%)	+125°C (%)	
Rated voltage (+85°C) 4 V - Category voltage (+125°C) 2,5 V										
6,8	S	CTC3E	0,5	5	6,2	9	6	9	12	15,0
10	S	CTC3E	0,5	5	6,2	9	6	9	12	15,0
15	T	CTC3E	0,6	6	7,5	9	6	9	12	5,0
22	S	CTC3E	0,9	9	11	15	10	15	20	10,0
22	T	CTC3E	0,9	9	11	9	6	9	12	5,0
33	U	CTC3E	1,3	13	16,5	9	6	9	12	1,8
47	T	CTC3E	1,9	19	23,5	9	6	9	12	1,8
47	U	CTC3E	1,9	19	23,5	9	6	9	12	1,8
68	U	CTC3E	2,7	27	34	9	6	9	12	1,8
100	T	CTC3E	4	40	50	45	30	45	60	5,0
150	V	CTC3E	6	60	75	11	8	11	14	0,7
220	V	CTC3E	8,8	88	110	11	8	11	14	0,7
330	V	CTC3E	13,2	132	165	18	12	18	24	0,7
Rated voltage (+85°C) 6,3 V - Category voltage (+125°C) 4 V										
4,7	S	CTC3E	0,5	5	6,2	9	6	9	12	15,0
6,8	S	CTC3E	0,5	5	6,2	9	6	9	12	15,0
10	T	CTC3E	0,6	6	7,8	9	6	9	12	5,0
15	S	CTC3E	0,9	9	11	22,5	15	22,5	30	10,0
15	T	CTC3E	0,9	9	11	9	6	9	12	5,0
22	T	CTC3E	1,4	14	17,5	12	8	12	16	5,0
22	U	CTC3E	1,3	13	17,3	9	6	9	12	1,8
33	T	CTC3E	2	20	25	18	12	18	24	6,0
33	U	CTC3E	2	20	25	9	6	9	12	1,8
47	U	CTC3E	2,9	29	36	9	6	9	12	1,8
100	U	CTC3E	6	60	75	15	10	15	20	1,8
100	V	CTC3E	6	60	75	11	8	11	14	0,7
150	V	CTC3E	9	90	112	11	8	11	14	0,7
220	V	CTC3E	13,2	132	165	18	12	18	20	0,7
Rated voltage (+85°C) 10 V - Category voltage (+125°C) 6,3 V										
3,3	S	CTC3E	0,5	5	6,2	9	6	9	12	15,0
4,7	S	CTC3E	0,5	5	6,2	9	6	9	12	15,0
6,8	S	CTC3E	0,7	7	8,7	15	10	15	20	15,0
6,8	T	CTC3E	0,6	6,8	8,5	9	6	9	12	5,0
10	S	CTC3E	1,0	10	12,5	15	10	15	20	15,0
10	T	CTC3E	1,0	10	12,5	9	6	9	12	5,0
15	T	CTC3E	1,5	15	18,7	12	8	12	16	5,0
15	U	CTC3E	1,5	15	18,7	9	6	9	12	1,8
22	T	CTC3E	2,2	22	27,5	18	12	18	24	8,0
22	U	CTC3E	2,2	22	27,5	9	6	9	12	1,8
33	U	CTC3E	3,3	33	41,2	9	6	9	12	1,8
33	V	CTC3E	3,3	33	41,2	9	6	9	12	0,7
47	U	CTC3E	4,7	47	58,7	15	10	15	20	2,2
47	V	CTC3E	4,7	47	58,7	9	6	9	12	0,7
68	U	CTC3E	6,8	68	85	15	10	15	20	1,8
68	V	CTC3E	6,8	68	85	9	6	9	12	0,7
100	V	CTC3E	10	100	125	11	8	11	14	0,7
150	V	CTC3E	15	150	187,5	12	8	12	16	0,7
Rated voltage (+85°C) 16 V - Category voltage (+125°C) 10 V										
2,2	S	CTC3E	0,5	5	6,2	9	6	9	12	15,0
4,7	T	CTC3E	0,7	7,5	9,4	9	6	9	12	5,0
10	T	CTC3E	1,6	16	20	12	8	12	16	8,0
10	U	CTC3E	1,6	16	20	9	6	9	12	1,8
15	U	CTC3E	2,4	24	30	9	6	9	12	1,8
22	U	CTC3E	3,6	36	45	15	10	15	20	3,0
33	U	CTC3E	5,3	53	66,2	18	12	18	24	3,0
47	V	CTC3E	7,5	75	94	9	6	9	12	0,7
100	V	CTC3E	16	160	200	18	12	18	24	0,7
Rated voltage (+85°C) 20 V - Category voltage (+125°C) 13 V										
1,0	S	CTC3E	0,5	5	6,2	9	6	9	12	18,0
1,5	S	CTC3E	0,5	5	6,2	9	6	9	12	15,0
3,3	T	CTC3E	0,7	6,6	8,2	9	6	9	12	5,0
6,8	U	CTC3E	1,3	13,6	17	9	6	9	12	1,9
10	U	CTC3E	2	20	25	9	6	9	12	1,8
22	V	CTC3E	4,4	44	55	9	6	9	12	0,7
33	V	CTC3E	6,6	66	82,5	12	8	12	16	0,7
Rated voltage (+85°C) 25 V - Category voltage (+125°C) 16 V										
22	V	CTC3E	5,5	55	68,7	9	6	9	12	0,7
Rated voltage (+85°C) 35 V - Category voltage (+125°C) 23 V										
10	V	CTC3E	3,5	35	43,7	9	5	9	12	2,0
Rated voltage (+85°C) 50 V - Category voltage (+125°C) 33 V										
1	V	CTC3E	0,5	5	6,2	6	4	6	8	6,0

CTC4 RSE

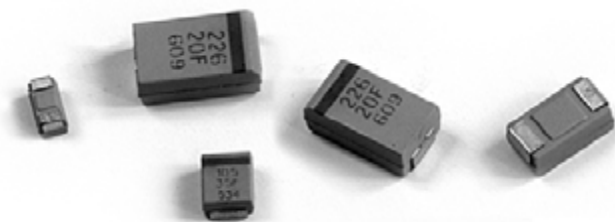

Solid tantalum MnO₂ capacitors

Molded cases

SMD

Low ESR

100% Tin [Sn] plated

Polarized

ELECTRICAL AND CLIMATIC CHARACTERISTICS

	CTC4 RSE
Operating temperature	-55°C +125°C
Damp heat	56 days
Capacitance range	4,7µF ⇒ 1000µF
Tolerance	±10% - ±20%
Voltage range	4V ⇒ 50V
Max. capacitance change -55°C	-10%
Max. capacitance change +85°C	+10%
Max. capacitance change +125°C	+12%
Maximum DF at +20°C	see table
Maximum DF at -55°C	see table
Maximum DF at +85°C	see table
Maximum DF at +125°C	see table
Max. leakage current at +20°C	see table
Max. leakage current at +85°C	see table
Max. leakage current at +125°C	see table
Max. ESR at 100kHz +20°C	see table
Max. ripple current 100kHz +20°C	see table
High surge current	100% - 4 cycles
Max. Reverse voltage at +20°C	15 % U _R
Max. Reverse voltage at +85°C	5 % U _R
Max. Reverse voltage at +125°C	1 % U _R
Max. surge voltage at +85°C	1,3 x U _R
Max. surge voltage at +125°C	1,3 x U _C

DIMENSIONS (mm)

Case code	Dimensions					
	L	W	H	P	Tw	Th min.
V	7,3±0,3	4,3±0,3	2,0±0,3	1,3±0,3	2,4±0,1	1,0
D	7,3±0,3	4,3±0,3	2,8±0,3	1,3±0,3	2,4±0,1	1,0
E	7,3±0,3	4,3±0,3	4,0±0,3	1,3±0,3	2,4±0,1	1,0

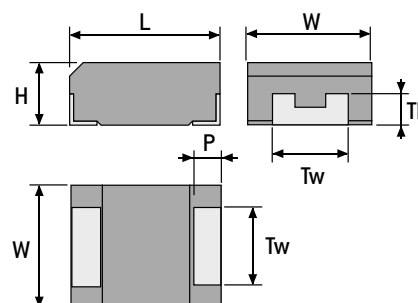

MARKING, PACKAGING, CONSTRUCTION:
see general characteristics

HOW TO ORDER

Commercial description	Model	Case	Capacitance in µF	Tolerance in %	DC Voltage	Termination (RoHS)
	CTC4 RSE	E	15µF	20%	50V	-
EXXELIA PN	Model code	Case	Capacitance code	Tolerance code	DC Voltage code	Termination (RoHS)
	TS84R	E	156	M	050	F

Expressed in pF with 3 digits: 2 digits for the value and the third for the multiplier

K = 10%
M = 20%

Expressed in volt with 3 digits

Commercial description
- = Sn100% (RoHS)

EXXELIA PN
F = Sn100% (RoHS)

CTC4 RSE

STANDARD RATINGS - ELECTRICAL CHARACTERISTICS

Capacitance 100Hz +20°C (μF)	Case (code)	Type	Max. I leak			Max. DF 100Hz		Max. ESR 100kHz +20°C (mΩ)	I _{rms} Max. +20°C (A)
			+20°C (μA)	+85°C (μA)	+125°C (μA)	-55°C +20°C (%)	+85°C +125°C (%)		
Rated voltage (+85°C) 4 V - Category voltage (+125°C) 2,5 V									
1000	E	CTC4 RSE	40	400	500	12	12	70	1,5
Rated voltage (+85°C) 6,3 V - Category voltage (+125°C) 4 V									
68	D	CTC4 RSE	4,3	42,8	53,6	4	4	175	0,9
100	V	CTC4 RSE	6,3	63,0	78,8	8	8	150	0,9
150	E	CTC4 RSE	9,5	94,5	118,1	6	6	100	1,3
220	D	CTC4 RSE	13,9	138,6	173,3	8	8	100	1,2
220	E	CTC4 RSE	13,9	138,6	173,3	8	8	100	1,3
330	D	CTC4 RSE	20,8	207,9	259,9	8	8	100	1,2
330	E	CTC4 RSE	20,8	207,9	259,9	8	8	100	1,3
470	D	CTC4 RSE	29,6	296,1	370,1	12	12	125	1,1
470	E	CTC4 RSE	29,6	296,1	370,1	10	10	65	1,6
Rated voltage (+85°C) 10 V - Category voltage (+125°C) 6,3 V									
47	D	CTC4 RSE	4,7	47	58,8	4	4	200	0,9
68	V	CTC4 RSE	6,8	68	85	6	6	140	0,9
68	D	CTC4 RSE	6,8	68	85	6	6	150	1,0
68	E	CTC4 RSE	6,8	68	85	4	4	150	1,0
100	V	CTC4 RSE	10	100	125	8	8	150	0,9
100	D	CTC4 RSE	10	100	125	8	8	100	1,2
100	E	CTC4 RSE	10	100	125	6	6	100	1,3
150	D	CTC4 RSE	15	150	187,5	8	8	100	1,2
150	E	CTC4 RSE	15	150	187,5	8	8	100	1,3
220	V	CTC4 RSE	22	220	275	12	12	150	0,9
220	D	CTC4 RSE	22	220	275	8	8	125	1,1
220	E	CTC4 RSE	22	220	275	8	8	100	1,3
330	D	CTC4 RSE	33	330	412,5	10	10	125	1,1
330	E	CTC4 RSE	33	330	412,5	10	10	60	1,7
Rated voltage (+85°C) 16 V - Category voltage (+125°C) 10 V									
33	D	CTC4 RSE	5,3	52,8	66	4	4	225	0,8
47	D	CTC4 RSE	7,5	75	94	6	6	150	1,0
68	D	CTC4 RSE	10,9	109	136	6	6	150	1,0
100	D	CTC4 RSE	16	160	200	8	8	125	1,1
100	E	CTC4 RSE	16	160	200	8	8	100	1,3
150	E	CTC4 RSE	24	240	300	8	8	100	1,3
Rated voltage (+85°C) 20 V - Category voltage (+125°C) 13 V									
15	D	CTC4 RSE	3	30	37,5	4	4	275	0,7
22	D	CTC4 RSE	4,4	44	55	4	4	225	0,8
33	D	CTC4 RSE	6,6	66	82,5	6	6	200	0,9
47	D	CTC4 RSE	9,4	94	117,5	6	6	175	0,9
47	E	CTC4 RSE	9,4	94	117,5	4	4	150	1,0
68	D	CTC4 RSE	13,6	136	170	8	8	150	1,0
68	E	CTC4 RSE	13,6	136	170	6	6	150	1,0
Rated voltage (+85°C) 25 V - Category voltage (+125°C) 16 V									
15	D	CTC4 RSE	3,8	37,5	46,9	6	6	275	0,7
15	E	CTC4 RSE	3,8	37,5	46,9	4	4	200	0,9
22	D	CTC4 RSE	5,5	55	68,8	6	6	200	0,9
22	E	CTC4 RSE	5,5	55	68,8	4	4	225	0,9
33	D	CTC4 RSE	8,3	82,5	103,2	6	6	300	0,7
33	E	CTC4 RSE	8,3	82,5	103,2	4	4	175	1,0
47	E	CTC4 RSE	11,8	117,5	146,9	6	6	200	0,9
68	E	CTC4 RSE	17,0	170	212,5	8	8	200	0,9
Rated voltage (+85°C) 35 V - Category voltage (+125°C) 23 V									
6,8	E	CTC4 RSE	2,4	23,8	29,8	4	4	300	0,7
10	D	CTC4 RSE	3,5	35	43,8	6	6	300	0,7
10	E	CTC4 RSE	3,5	35	43,8	4	4	250	0,8
15	D	CTC4 RSE	5,3	52,5	65,7	6	6	300	0,7
15	E	CTC4 RSE	5,3	52,5	65,7	6	6	225	0,9
22	D	CTC4 RSE	7,7	77	96,3	6	6	300	0,7
22	E	CTC4 RSE	7,7	77	96,3	6	6	275	0,8
33	E	CTC4 RSE	11,6	115,5	144,4	6	6	250	0,8
47	E	CTC4 RSE	16,5	164,5	205,6	8	8	300	0,7
Rated voltage (+85°C) 50 V - Category voltage (+125°C) 32 V									
4,7	D	CTC4 RSE	2,4	23,5	29,4	6	6	300	0,7
4,7	E	CTC4 RSE	2,4	23,5	29,4	4	4	300	0,7
6,8	D	CTC4 RSE	3,4	34	42,5	8	8	300	0,7
15	E	CTC4 RSE	7,5	75	93,7	8	8	300	0,7

SMD - Tape & Reel Packaging (CTC3, CTC3E, CTC4, CTC4 RSE)

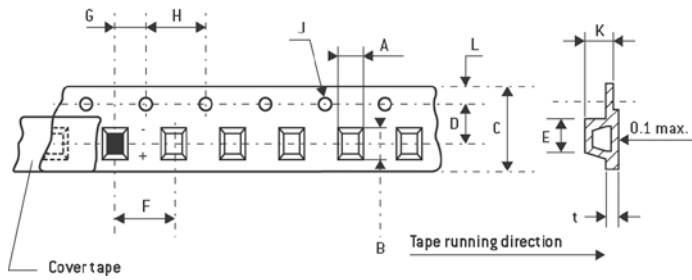

Semitransparent emboss plastic tape
Polyester cover tape

Dimension (mm)	Size A	Size B	Size C	Size D
A	2,3 ±0,2	3,3 ±0,2	3,6 ±0,2	4,7 ±0,2
B	4,2 ±0,2	3,8 ±0,2	6,4 ±0,2	7,7 ±0,2
C	8 ±0,3	8 ±0,3	12 ±0,3	12 ±0,3
D	3,5 ±0,1	3,5 ±0,05	5,5 ±0,1	5,5 ±0,1
E	5 max.	5 max.	8,4 max.	8,4 max.
F	4 ±0,1	4 ±0,1	8 ±0,1	8 ±0,1
G	2 ±0,1			
H	4 ±0,1			
J	[Dia.] 1,5 ^{+0,1/-0}			
t	0,4 max.			
K	2,4 max.	2,4 max.	4,5 max.	4,5 max.
L	1,75 ^{+0,15/-0,4}			

REEL SIZE (mm)

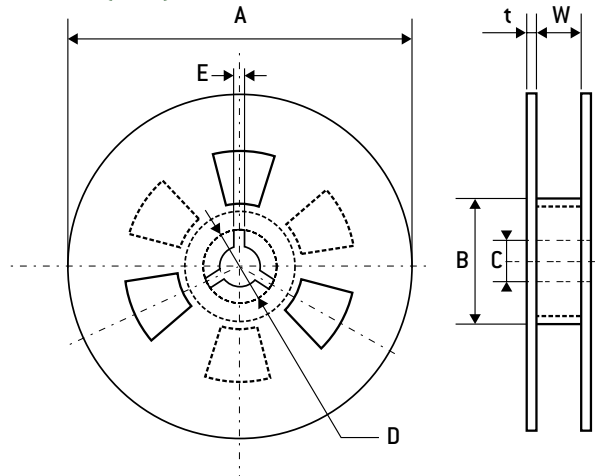

A	B	C	D
178 ±2	50 min.	13 ±0,5	21 ±0,8
E	W	W	t
2 ±0,5	10 ±1,5 for size A, B	14 ±1,5 for size C, D	3 max.

[Sizes] A, B = 2000
[Sizes] C, D = 500

CTC21

CTC21E



Solid tantalum MnO₂ capacitors
Molded cases
SMD
Very low ESR
Polarized

ELECTRICAL AND CLIMATIC CHARACTERISTICS

	CTC21	CTC21E
Detail specification	CECC 30801-013 ESCC 3012/002 - ESA-ESCC EPPL 1	CECC 30801-013 ESCC 3012/003 - ESA-ESCC EPPL 1
Operating temperature	-55°C + 125°C	-55°C + 125°C
Damp heat	56 days	56 days
Capacitance range	5,6µF ⇒ 330µF	10µF ⇒ 680µF
Tolerance	±10% - ±20%	±10% - ±20%
Voltage range	6,3V ⇒ 63V	6,3V ⇒ 100V
Max. capacitance change -55°C	-10%	-10%
Max. capacitance change +85°C	+8%	+8%
Max. capacitance change +125°C	+12%	+12%
Maximum DF at +20°C	see table	see table
Maximum DF at -55°C	= 2,0 x lim20°C	= 2,0 x lim20°C
Maximum DF at +85°C	= 1,5 x lim20°C	= 1,5 x lim20°C
Maximum DF at +125°C	= 1,5 x lim20°C	= 1,5 x lim20°C
Max. leakage current at +20°C	see table	see table
Max. leakage current at +85°C	see table	see table
Max. leakage current at +125°C	see table	see table
Max. ESR at 500kHz +20°C	see table	see table
Max. ripple current 1kHz +20°C	see table	see table
Max. ripple current 500kHz +20°C	see table	see table
High surge current	1 million cycles	1 million cycles
Max. Reverse voltage at +20°C	10 % U _R	10 % U _R
Max. Reverse voltage at +85°C	5 % U _R	5 % U _R
Max. Reverse voltage at +125°C	1 % U _R	1 % U _R
Max. surge voltage at +85°C	1,3 x U _R	1,3 x U _R
Max. surge voltage at +125°C	1,3 x U _C	1,3 x U _C

DIMENSIONS (mm)

Case code	Dimensions					
	L - 0,1 +0,5	W - 0,1 +0,5	H - 0,1 +0,5	Tw ± 0,3	P ± 0,3	T ± 0,3
C	11	9	4,5	7	1,5	2
D	11	12,5	5,5	10,5	1,5	3

MARKING, PACKAGING, CONSTRUCTION:
 see general characteristics

HOW TO ORDER

Commercial description	Model		Case	Capacitance in µF	Tolerance in %	DC Voltage	Termination	Packaging
	CTC21	CTC21E						
EXXELIA PN	Model code		Case	Capacitance code	Tolerance code	DC Voltage code	Termination	Packaging
	TS22	TS22E	D	336	M	040	F	R

Expressed in pF with 3 digits: 2 digits for the value and the third for the multiplier

K = 10%
M = 20%

Expressed in volt with 3 digits

Commercial description / EXXELIA PN
 T = Tinning electrolytic SnPb (non RoHS)
 F = Tinning electrolytic Sn100% (RoHS)
 S = Hot solder dipped (non RoHS)
 A = Silver plated (RoHS)

- = Bulk
R = Tape & Reel

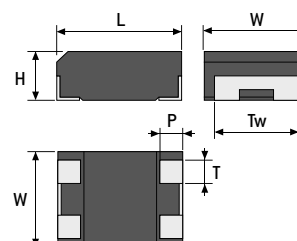

[Standard range]

CTC21

STANDARD RATINGS - ELECTRICAL CHARACTERISTICS

Capacitance 1kHz +20°C (μF)	Case (code)	Type	Max. I leak			Max. DF +20°C (%)	Max. ESR 500kHz +20°C (mΩ)	Irms Max. 1kHz +20°C (A)	Irms Max. 500kHz +20°C (A)
			+20°C (μA)	+85°C (μA)	+125°C (μA)				
Rated voltage (+85°C) 6,3 V - Category voltage (+125°C) 4 V									
120	C	CTC21	7,6	76	95	8	40	2,5	3,2
150	C	CTC21	9,4	94	117	10	35	2,0	3,3
270	D	CTC21	17,0	170	212	10	30	3,4	4,1
330	D	CTC21	20,8	208	260	12	25	3,8	4,3
Rated voltage (+85°C) 10 V - Category voltage (+125°C) 6,3 V									
82	C	CTC21	8,2	82	102	8	45	1,8	2,9
100	C	CTC21	10,0	100	125	8	40	2,2	3,0
180	D	CTC21	18,0	180	225	8	35	3,4	3,7
220	D	CTC21	22,0	220	275	10	30	3,4	3,9
Rated voltage (+85°C) 16 V - Category voltage (+125°C) 10 V									
56	C	CTC21	8,9	89	111	6	55	1,8	2,6
68	C	CTC21	10,8	108	135	6	50	2,2	2,7
120	D	CTC21	19,2	192	240	8	40	2,8	3,5
150	D	CTC21	24,0	240	300	8	35	3,1	3,6
Rated voltage (+85°C) 20 V - Category voltage (+125°C) 13 V									
39	C	CTC21	7,8	78	97	5	65	1,7	2,4
47	C	CTC21	9,4	94	117	6	60	1,8	2,5
82	D	CTC21	16,4	164	205	6	45	2,5	3,1
100	D	CTC21	20,0	200	250	8	40	2,5	3,3
Rated voltage (+85°C) 25 V - Category voltage (+125°C) 16 V									
27	C	CTC21	6,7	67	83	5	75	1,2	2,2
33	C	CTC21	8,2	82	102	5	70	1,4	2,3
56	D	CTC21	14,0	140	175	6	55	2,2	2,9
68	D	CTC21	17,0	170	212	6	50	2,4	3,0
Rated voltage (+85°C) 40 V - Category voltage (+125°C) 25 V									
22	C	CTC21	8,8	88	110	4	85	1,5	2,1
33	D	CTC21	13,2	132	165	5	70	1,9	2,5
47	D	CTC21	18,8	188	235	5	60	2,2	2,7
Rated voltage (+85°C) 50 V - Category voltage (+125°C) 32 V									
15	C	CTC21	7,5	75	93	3	100	1,4	1,9
18	C	CTC21	9,0	90	112	4	90	1,4	2,0
22	D	CTC21	11,0	110	137	4	85	1,7	2,3
Rated voltage (+85°C) 63 V - Category voltage (+125°C) 40 V									
5,6	C	CTC21	3,5	35	44	3	155	0,6	1,5
6,8	C	CTC21	4,2	42	53	3	140	0,7	1,6
8,2	C	CTC21	5,1	51	64	3	130	0,9	1,6
10	C	CTC21	6,3	63	78	3	120	1,1	1,7
18	D	CTC21	11,3	113	141	4	90	1,5	2,1
22	D	CTC21	13,8	138	173	4	85	1,7	2,3

STANDARD TERMINATIONS:

- T tinning electrolytic SnPb (non RoHS)
- F tinning electrolytic 100% Sn (RoHS)

UPON REQUEST:

- S hot solder dipped (add 0,4 mm to dimensions L and H) (non RoHS)
- A silver plated for epoxy bonding (RoHS)

PACKAGING:

Standard: Bulk

Optional: Tape & Reel

When ordering add the suffix «R» just after the termination code.

CTC21E**[Extended range]****STANDARD RATINGS - ELECTRICAL CHARACTERISTICS**

Capacitance 1kHz +20°C (μF)	Case (code)	Type	Max. I leak			Max. DF +20°C (%)	Max. ESR 500kHz +20°C (mΩ)	Irms Max. 1kHz +20°C (A)	Irms Max. 500kHz +20°C (A)
			+20°C (μA)	+85°C (μA)	+125°C (μA)				
Rated voltage (+85°C) 6,3 V - Category voltage (+125°C) 4 V									
270	C	CTC21E	17,0	170	212	16	45	2,0	2,9
330	C	CTC21E	20,8	208	260	20	45	2,0	2,9
560	D	CTC21E	35,3	353	441	24	35	2,5	3,6
680	D	CTC21E	42,8	428	535	30	35	2,5	3,6
Rated voltage (+85°C) 10 V - Category voltage (+125°C) 6,3 V									
180	C	CTC21E	18,0	180	225	12	50	1,9	2,7
220	C	CTC21E	22,0	220	275	12	45	2,0	2,9
390	D	CTC21E	39,0	390	487	20	35	2,5	3,6
470	D	CTC21E	47,0	470	587	22	35	2,5	3,6
Rated voltage (+85°C) 16 V - Category voltage (+125°C) 10 V									
120	C	CTC21E	19,2	192	240	10	55	1,8	2,6
150	C	CTC21E	24,0	240	300	12	50	2,0	2,9
270	D	CTC21E	43,2	432	540	16	45	2,3	3,5
330	D	CTC21E	52,8	528	660	20	45	2,5	3,6
Rated voltage (+85°C) 20 V - Category voltage (+125°C) 13 V									
82	C	CTC21E	16,4	164	205	6	65	1,7	2,4
100	C	CTC21E	20,0	200	250	8	60	1,7	2,5
180	D	CTC21E	36,0	360	450	12	50	2,1	3,0
220	D	CTC21E	44,0	440	550	12	45	2,2	3,1
Rated voltage (+85°C) 25 V - Category voltage (+125°C) 16 V									
39	C	CTC21E	9,7	97	121	5	95	1,4	2,0
47	C	CTC21E	11,7	117	146	6	85	1,5	2,1
82	D	CTC21E	20,5	205	256	6	65	1,8	2,6
100	D	CTC21E	25,0	250	312	8	60	1,9	2,7
Rated voltage (+85°C) 40 V - Category voltage (+125°C) 25 V									
33	C	CTC21E	13,2	132	165	5	100	1,3	1,9
56	D	CTC21E	22,4	224	280	6	80	1,6	2,3
68	D	CTC21E	27,2	272	340	6	75	1,7	2,4
Rated voltage (+85°C) 50 V - Category voltage (+125°C) 32 V									
22	C	CTC21E	11,0	110	137	5	125	1,2	1,7
47	D	CTC21E	23,5	235	293	6	85	1,6	2,3
Rated voltage (+85°C) 63 V - Category voltage (+125°C) 40 V									
12	C	CTC21E	7,5	75	93	5	160	1,1	1,5
15	C	CTC21E	9,4	94	117	5	145	1,1	1,6
33	D	CTC21E	20,8	208	260	5	100	1,5	2,1
Rated voltage (+85°C) 100 V - Category voltage (+125°C) 63 V									
10	C	CTC21E	10,0	100	125	5	175	1,0	1,4
22	D	CTC21E	22,0	220	275	5	125	1,3	1,9

STANDARD TERMINATIONS:

- T tinning electrolytic SnPb (non RoHS)
- F tinning electrolytic 100% Sn (RoHS)

UPON REQUEST:

- S hot solder dipped (add 0,4 mm to dimensions L and H) (non RoHS)
- A silver plated for epoxy bonding (RoHS)

PACKAGING:**Standard:** Bulk**Optional:** Tape & Reel

When ordering add the suffix «R» just after the termination code.

CTC23



Solid tantalum MnO₂ capacitors
Molded cases
SMD
High capacitance
 Polarized

ELECTRICAL AND CLIMATIC CHARACTERISTICS

	CTC23
Operating temperature	-55°C +125°C
Damp heat	56 days
Capacitance range	15µF ⇒ 1000µF
Tolerance	±10% - ±20%
Voltage range	6,3V ⇒ 63V
Max. capacitance change -55°C	-10%
Max. capacitance change +85°C	+8%
Max. capacitance change +125°C	+12%
Maximum DF at +20°C	see table
Maximum DF at -55°C	= lim 20°C
Maximum DF at +85°C	= lim 20°C
Maximum DF at +125°C	= lim 20°C
Max. leakage current at +20°C	see table
Max. leakage current at +85°C	see table
Max. leakage current at +125°C	see table
Max. Impedance at 100kHz +20°C	see table
Max. Reverse voltage at +20°C	10 % U _R
Max. Reverse voltage at +85°C	5 % U _R
Max. Reverse voltage at +125°C	1 % U _R
Max. surge voltage at +85°C	1,3 x U _R
Max. surge voltage at +125°C	1,3 x U _C

DIMENSIONS (mm)

Case code	Dimensions					
	L - 0,1+0,5	W - 0,1+0,5	H - 0,1+0,5	Tw ± 0,3	P ± 0,3	T ± 0,3
C	11	9	4,5	7	1,5	2
D	11	12,5	5,5	10,5	1,5	3

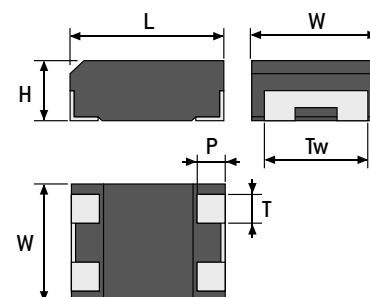

MARKING, PACKAGING, CONSTRUCTION:
 see general characteristics

HOW TO ORDER

Commercial description	Model	Case	Capacitance in µF	Tolerance in %	DC Voltage	Termination	Packaging
	CTC23	D	39µF	20%	63V	F	R
EXXELIA PN	Model code	Case	Capacitance code	Tolerance code	DC Voltage code	Termination	Packaging
	TS29	D	396	M	063	F	
			Expressed in pF with 3 digits: 2 digits for the value and the third for the multiplier	K = 10% M = 20%	Expressed in volt with 3 digits	Commercial description / EXXELIA PN T = Tinning electrolytic SnPb (non RoHS) F = Tinning electrolytic Sn100% (RoHS) S = Hot solder dipped (non RoHS)	
						- = Bulk	R = Tape & Reel

CTC23

STANDARD RATINGS - ELECTRICAL CHARACTERISTICS

Capacitance 100Hz +20°C (μ F)	Case (code)	Type	Max. I leak			Max. DF +20°C (%)	Max. Impedance +20°C (Ω)
			+20°C (μ A)	+85°C (μ A)	+125°C (μ A)		
Rated voltage (+85°C) 6,3 V - Category voltage (+125°C) 4 V							
330	C	CTC23	20,8	208	259	10	1
390	C	CTC23	24,5	245	307	10	1
470	C	CTC23	29,6	296	370	10	1
680	D	CTC23	42,8	428	535	10	0,5
820	D	CTC23	51,6	516	645	10	0,5
1000	D	CTC23	63	630	787	10	0,5
Rated voltage (+85°C) 10 V - Category voltage (+125°C) 6,3 V							
220	C	CTC23	22	220	275	10	1
270	C	CTC23	27	270	337	10	1
390	D	CTC23	39	390	487	10	0,5
470	D	CTC23	47	470	587	10	0,5
560	D	CTC23	56	560	700	10	0,5
Rated voltage (+85°C) 16 V - Category voltage (+125°C) 10 V							
150	C	CTC23	24	240	300	10	1
180	C	CTC23	28,8	288	360	10	1
270	D	CTC23	43,2	432	540	10	0,5
330	D	CTC23	52,8	528	660	10	0,5
Rated voltage (+85°C) 20 V - Category voltage (+125°C) 13 V							
100	C	CTC23	20	200	250	10	1
120	C	CTC23	24	240	300	10	1
150	C	CTC23	30	300	375	10	1
180	D	CTC23	36	360	450	10	0,5
220	D	CTC23	44	440	550	10	0,5
270	D	CTC23	54	540	675	10	0,5
Rated voltage (+85°C) 25 V - Category voltage (+125°C) 16 V							
33	C	CTC23	8,2	82,5	103	8	1
47	C	CTC23	11,7	117	146	8	1
68	C	CTC23	17	170	212	8	1
82	C	CTC23	20,5	205	256	10	1
100	D	CTC23	25	250	312	10	0,5
120	D	CTC23	30	300	375	10	0,5
150	D	CTC23	37,5	375	468	10	0,5
Rated voltage (+85°C) 40 V - Category voltage (+125°C) 25 V							
33	C	CTC23	13,2	132	165	8	1
39	C	CTC23	15,6	156	195	8	1
47	D	CTC23	18,8	188	235	10	0,5
68	D	CTC23	27,2	272	340	10	0,5
82	D	CTC23	32,8	328	410	10	0,5
100	D	CTC23	40	400	500	10	0,5
Rated voltage (+85°C) 50 V - Category voltage (+125°C) 32 V							
22	C	CTC23	11	110	137	8	1
27	C	CTC23	13,5	135	168	8	1
47	D	CTC23	23,5	235	293	10	0,5
56	D	CTC23	28	280	350	10	0,5
Rated voltage (+85°C) 63 V - Category voltage (+125°C) 4 V							
15	C	CTC23	9,4	94,5	118	8	1
18	C	CTC23	11,3	113	141	8	1
33	D	CTC23	20,7	207	259	10	0,5
39	D	CTC23	24,5	245	307	10	0,5

NOTE

See notes of CTC21

CTC42 CTC42E



Solid tantalum MnO₂ capacitors
Stacked molded cases
SMD
High capacitance
Very low ESR
Polarized

ELECTRICAL AND CLIMATIC CHARACTERISTICS

	CTC42	CTC42E
Operating temperature	-55°C +125°C	-55°C +125°C
Damp heat	56 days	56 days
Capacitance range	12µF ⇒ 680µF	22µF ⇒ 1500µF
Tolerance	±10% - ±20%	±10% - ±20%
Voltage range	6,3V ⇒ 63V	6,3V ⇒ 80V
Max. capacitance change -55°C	-10%	-10%
Max. capacitance change +85°C	+8%	+8%
Max. capacitance change +125°C	+12%	+12%
Maximum DF at +20°C	see table	see table
Maximum DF at -55°C	= 2,0 x lim20°C	= 2,0 x lim20°C
Maximum DF at +85°C	= 1,5 x lim20°C	= 1,5 x lim20°C
Maximum DF at +125°C	= 1,5 x lim20°C	= 1,5 x lim20°C
Max. leakage current at +20°C	see table	see table
Max. leakage current at +85°C	see table	see table
Max. leakage current at +125°C	see table	see table
Max. ESR at 100kHz +20°C	see table	see table
Max. ripple current 1kHz +20°C	see table	see table
Max. ripple current 100kHz +20°C	see table	see table
High surge current	1 million cycles	1 million cycles
Max. reverse voltage at +20°C	10 % U _R	10 % U _R
Max. reverse voltage at +85°C	5 % U _R	5 % U _R
Max. reverse voltage at +125°C	1 % U _R	1 % U _R
Max. surge voltage at +85°C	1,3 x U _R	1,3 x U _R
Max. surge voltage at +125°C	1,3 x U _C	1,3 x U _C

DIMENSIONS (mm)

Case code	Dimensions					
	L - 0,1 +0,5	W - 0,1 +0,5	H - 0,1 +0,5	Tw ± 0,3	P ± 0,3	T ± 0,3
C	12	9	9,5	7	1,5	2
D	12	12,5	11,5	10,5	1,5	3

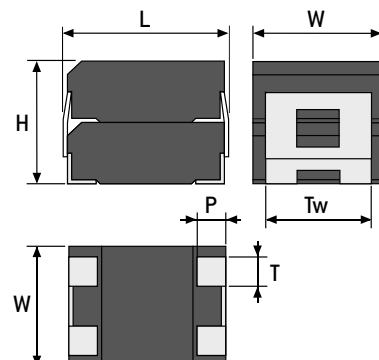

MARKING, PACKAGING, CONSTRUCTION:
 see general characteristics

HOW TO ORDER

Commercial description	Model		Case	Capacitance in µF	Tolerance in %	DC Voltage	Termination
	CTC42	CTC42E					
			D	47µF	20%	63V	F
EXXELIA PN	Model code		Case	Capacitance code	Tolerance code	DC Voltage code	Termination
	TS42	TS42E					
			D	476	M	063	F

Expressed in pF with 3 digits: 2 digits for the value and the third for the multiplier

K = 10%
 M = 20%

Expressed in volt with 3 digits

Commercial description / EXXELIA PN
 S = hot solder dipped (non RoHS)
 F = hot solder dipped 100% Sn (RoHS)

CTC42**[Standard range]****STANDARD RATINGS - ELECTRICAL CHARACTERISTICS**

Capacitance 1kHz +20°C (μF)	Case (code)	Type	Max. I leak			Max. DF +20°C (%)	Max. ESR 500kHz +20°C (mΩ)	I _{rms} Max. 1kHz +20°C (A)	I _{rms} Max. 500kHz +20°C (A)
			+20°C (μA)	+85°C (μA)	+125°C (μA)				
Rated voltage (+85°C) 6,3 V - Category voltage (+125°C) 4 V									
270	C	CTC42	17,0	170	212	8	25	5,0	6,4
330	C	CTC42	20,8	208	260	10	25	5,6	6,6
560	D	CTC42	35,3	353	441	10	25	6,8	8,2
680	D	CTC42	42,8	428	535	12	25	7,6	8,6
Rated voltage (+85°C) 10 V - Category voltage (+125°C) 6,3 V									
160	C	CTC42	16	160	200	8	25	3,6	5,8
220	C	CTC42	22	220	275	8	25	4,4	6,0
390	D	CTC42	39	390	487	8	25	6,8	7,4
470	D	CTC42	47	470	587	10	25	6,8	7,8
Rated voltage (+85°C) 16 V - Category voltage (+125°C) 10 V									
120	C	CTC42	19,2	192	240	6	35	3,6	5,2
150	C	CTC42	24	240	300	6	30	4,4	5,4
270	D	CTC42	43,2	432	540	8	25	5,6	7,0
330	D	CTC42	52,8	528	660	8	25	6,2	7,2
Rated voltage (+85°C) 20 V - Category voltage (+125°C) 13 V									
82	C	CTC42	16,4	164	205	5	35	3,4	4,8
100	C	CTC42	20	200	250	6	35	3,6	5,0
180	D	CTC42	36	360	450	6	25	5,0	6,2
220	D	CTC42	44	440	550	8	25	5,0	6,6
Rated voltage (+85°C) 25 V - Category voltage (+125°C) 16 V									
56	C	CTC42	14	140	175	4	40	2,4	4,4
68	C	CTC42	17	170	212	5	40	2,8	4,6
120	D	CTC42	30	300	375	6	30	4,4	5,8
150	D	CTC42	37,5	375	469	6	30	4,8	6,0
Rated voltage (+85°C) 40 V - Category voltage (+125°C) 25 V									
47	C	CTC42	18,8	188	235	4	45	3,0	4,2
68	D	CTC42	27,2	272	340	5	35	3,8	5,0
100	D	CTC42	40	400	500	5	30	4,4	5,4
Rated voltage (+85°C) 50 V - Category voltage (+125°C) 32 V									
33	C	CTC42	16,5	165	206	3	50	2,8	3,8
39	C	CTC42	19,5	195	244	4	45	2,8	4,0
47	D	CTC42	23,5	235	294	4	45	3,4	4,6
Rated voltage (+85°C) 63 V - Category voltage (+125°C) 40 V									
12	C	CTC42	7,6	76	94	3	80	1,2	3,0
15	C	CTC42	9,5	95	118	3	70	1,4	3,2
18	C	CTC42	11,3	113	142	3	65	1,8	3,2
22	C	CTC42	13,9	139	173	3	60	2,2	3,4
39	D	CTC42	24,6	246	307	4	45	3,0	4,2
47	D	CTC42	29,6	296	370	4	45	3,4	4,6

STANDARD TERMINATIONS:

- S** hot solder dipped (non RoHS)
- F** hot solder dipped 100% Sn (RoHS)

PACKAGING:**Standard:** Bulk

[Extended range]

CTC42E

STANDARD RATINGS - ELECTRICAL CHARACTERISTICS

Capacitance 1kHz +20°C (μF)	Case (code)	Type	Max. I leak			Max. DF +20°C (%)	Max. ESR 500kHz +20°C (mΩ)	Irms Max. 1kHz +20°C (A)	Irms Max. 500kHz +20°C (A)
			+20°C (μA)	+85°C (μA)	+125°C (μA)				
Rated voltage (+85°C) 6,3 V - Category voltage (+125°C) 4 V									
560	C	CTC42E	35,3	353	441	16	30	4,0	5,8
680	C	CTC42E	42,8	428	535	20	30	4,0	5,8
1200	D	CTC42E	75,6	756	945	24	25	5,0	7,2
1500	D	CTC42E	94,5	945	1181	30	25	5,0	7,2
Rated voltage (+85°C) 10 V - Category voltage (+125°C) 6,3 V									
390	C	CTC42E	39	390	487	12	30	3,8	5,4
470	C	CTC42E	47	470	587	12	30	4,0	5,8
820	D	CTC42E	82	820	1025	20	25	5,0	7,2
1000	D	CTC42E	100	1000	1250	22	25	5,0	7,2
Rated voltage (+85°C) 16 V - Category voltage (+125°C) 10 V									
270	C	CTC42E	43,2	432	540	10	30	3,6	5,2
330	C	CTC42E	52,8	528	660	12	25	4,0	5,8
560	D	CTC42E	89,6	896	1120	16	25	4,6	7,0
680	D	CTC42E	109	1088	1360	20	25	5,0	7,2
Rated voltage (+85°C) 20 V - Category voltage (+125°C) 13 V									
180	C	CTC42E	36	360	450	6	35	3,4	4,8
220	C	CTC42E	44	440	550	8	35	3,4	5,0
390	D	CTC42E	78	780	975	12	30	4,2	6,0
470	D	CTC42E	94	940	1175	12	30	4,4	6,2
Rated voltage (+85°C) 25 V - Category voltage (+125°C) 16 V									
82	C	CTC42E	20,5	205	256	5	50	2,8	4,0
100	C	CTC42E	25	250	312	6	45	3,0	4,2
180	D	CTC42E	45	450	562	6	35	3,6	5,2
220	D	CTC42E	55	550	687	8	35	3,8	5,4
Rated voltage (+85°C) 40 V - Category voltage (+125°C) 25 V									
68	C	CTC42E	27,2	272	340	5	50	2,6	3,8
120	D	CTC42E	48	480	600	6	40	3,2	4,6
150	D	CTC42E	60	600	750	6	40	3,4	4,8
Rated voltage (+85°C) 50 V - Category voltage (+125°C) 32 V									
47	C	CTC42E	23,5	235	294	5	65	2,4	3,4
100	D	CTC42E	50	500	625	6	45	3,2	4,6
Rated voltage (+85°C) 63 V - Category voltage (+125°C) 40 V									
27	C	CTC42E	17	170	213	5	80	2,2	3,0
33	C	CTC42E	20,8	208	260	5	75	2,2	3,2
68	D	CTC42E	42,8	428	535	5	50	3,0	4,2
Rated voltage (+85°C) 80 V - Category voltage (+125°C) 50 V									
22	C	CTC42E	22	220	275	5	90	2,0	2,8
47	D	CTC42E	47	470	587	5	70	2,6	3,8

STANDARD TERMINATIONS:

- S hot solder dipped (non RoHS)
- F hot solder dipped 100% Sn (RoHS)

PACKAGING:

Standard: Bulk

SMT47



Solid tantalum MnO₂ capacitors
Molded cases
SMD
Very high capacitance
 Polarized

ELECTRICAL AND CLIMATIC CHARACTERISTICS

	SMT47
Detail specification	According to IEC 60384-3
Operating temperature	-55°C to +125°C
Damp Heat (+40°C, 95% HR)	56 days
Capacitance range	47μF ⇒ 1500μF
Tolerance	10% or 20%
Voltage range	6.3V ⇒ 63V
Max. capacitance change -55°C	-10%
Max. capacitance change +85°C	+8%
Max. capacitance change +125°C	+12%
Maximum DF at +20°C	see table
Maximum DF at -55°C	2 x lim20°C
Maximum DF at +85°C	1,5 x lim20°C
Maximum DF at +125°C	1,5 x lim20°C
Max. reverse voltage at +20°C	5% U _R
Max. reverse voltage at +85°C	3% U _R
Max. reverse voltage at +125°C	1% U _R
Max. surge voltage at +85°C	1,3 x U _R
Max. surge voltage at +125°C	1,3 x U _C
High surge current	1 million of cycles
Life testing	2000 h at +85°C under rated voltage or 2000 h at +125°C under category voltage
Solderability	MIL STD 202 method 208

DIMENSIONS (mm)

Case code	Dimensions with insulating sleeve					
	L ⁻¹ _{+0.5}	W ⁻¹ _{+0.5}	H ⁻¹ _{+0.5}	Tw ⁻¹ _{+0.5}	P ⁻¹ _{+0.5}	T ⁻¹ _{+0.5}
D	11.0	12.5	5.5	10.5	1.5	3.0

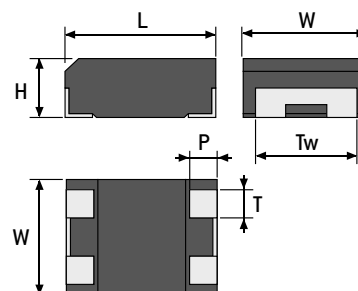

MARKING, PACKAGING, CONSTRUCTION:
 see general characteristics

HOW TO ORDER

Commercial description	Model	Case	Capacitance in μF	Tolerance in %	DC Voltage	Termination	Packaging
	SMT47	D	47μF	20%	63V	F	R
EXXELIA PN	Model code	Case	Capacitance code	Tolerance code	DC Voltage code	Termination	Packaging
	SMT47	D	476	M	063	F	
			Expressed in pF with 3 digits: 2 digits for the value and the third for the multiplier	K = 10% M = 20%	Expressed in volt with 3 digits	Commercial description / EXXELIA PN T = SnPb (No RoHS) F = Sn100% (RoHS)	
							- = Bulk R = Tape & Reel

STANDARD RATINGS - ELECTRICAL CHARACTERISTICS

Capacitance 100Hz +20°C (μF)	Case (code)	Maximum leakage current			Max. DF 100Hz (%)	Max. ESR 500kHz +20°C (mΩ)	I rms Max.	
		+20°C (μA)	+85°C (μA)	+125°C (μA)			100kHz (A)	500kHz (A)
Rated voltage (+85°C) 6.3 V - Category voltage (+125°C) 4 V								
1000	D	63	630	787	10	40	1.5	3.4
1500	D	94	940	1181	12	35	1.9	3.2
Rated voltage (+85°C) 10 V - Category voltage (+125°C) 6.3 V								
820	D	82	820	1025	10	50	1.4	3.0
1000	D	100	1000	1250	10	40	1.5	3.6
Rated voltage (+85°C) 16 V - Category voltage (+125°C) 10 V								
560	D	84	840	1050	10	85	1.3	2.3
680	D	102	1020	1275	10	75	1.4	2.4
Rated voltage (+85°C) 20 V - Category voltage (+125°C) 13 V								
330	D	66	660	825	10	120	1.0	2.0
470	D	94	940	1181	10	100	1.2	2.1
Rated voltage (+85°C) 25 V - Category voltage (+125°C) 16 V								
120	D	30	300	375	10	100	0.5	2.1
150	D	38	375	468	10	95	0.6	2.2
Rated voltage (+85°C) 35 V - Category voltage (+125°C) 22 V								
82	D	29	28.7	359	10	90	0.5	2.2
100	D	35	350	438	10	85	0.5	2.2
Rated voltage (+85°C) 50 V - Category voltage (+125°C) 32 V								
68	D	34	340	425	8	100	0.4	2.1
Rated voltage (+85°C) 63 V - Category voltage (+125°C) 40 V								
47	D	29.6	296	370	5	125	0.4	1.7

STANDARD TERMINATIONS:

- T tinning electrolytic SnPb (non RoHS)
- F tinning electrolytic 100% Sn (RoHS)

PACKAGING:

Standard: Bulk

Optional: Tape & Reel

When ordering add the suffix «R» just after the termination code.

Tape & Reel packaging (CTC21, CTC23, SMT47)

As per IEC 286-3

TAPE DIMENSIONS (mm)

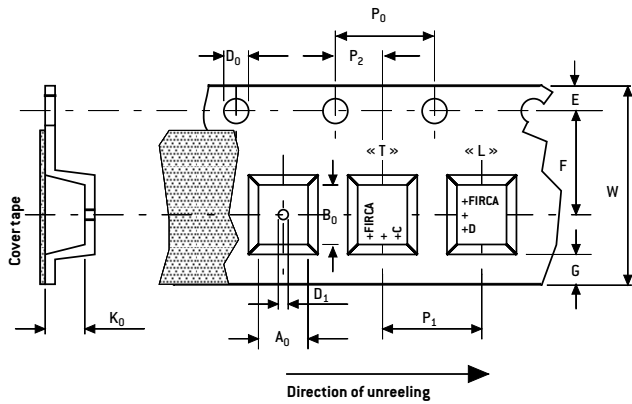

W ± 0,3	E ± 0,1	F ± 0,05	P ₀ ± 0,1	D ₀ + 0,1 - 0	D ₁ ± 0,1	G min.	P ₁ ± 0,1	P ₂ ± 0,05
24,0	1,75	11,5	4,0	1,5	1,5	0,75	12,0	2,0
24,0	1,75	11,5	4,0	1,5	1,5	0,75	16,0	2,0

Note: A₀ B₀ K₀ are defined by component size
Reel diameter: 330 mm (nominal)
Diameter of central hole: 12,8 mm

REEL CHARACTERISTICS

Case (code)	Tape width (mm)	Quantity per Reel (mm)	Position	Pitch
C	24,0	800	T	12,0
D	24,0	400	L	16,0

Note: The minimum quantity per reel is 50% of the above mentioned one

COMPONENT POSITION

T = Transversal (+ termination away from the sprocket hole)

L = Longitudinal (+ termination in the direction of unreeling)

EXXELIA Components Portfolio

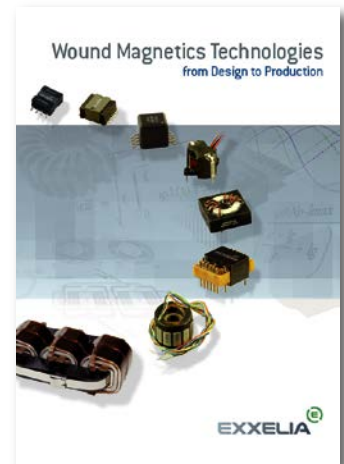
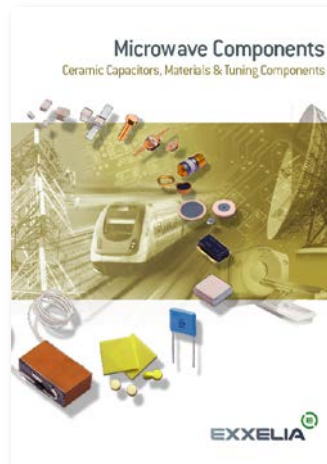



Z.I. de Brais
2, rue René Réaumur
44604 SAINT-NAZAIRE • FRANCE

Tel. : +33 (0)2 40 01 26 51

info@exxelia.com

www.exxelia.com

